

BATTLETECH[®]

THE RETURN OF KERENSKY

8 6 1 4

TECHNICAL[™]
READOUT:



3



0



5



0

REVISED
EDITION

FASA
CORPORATION

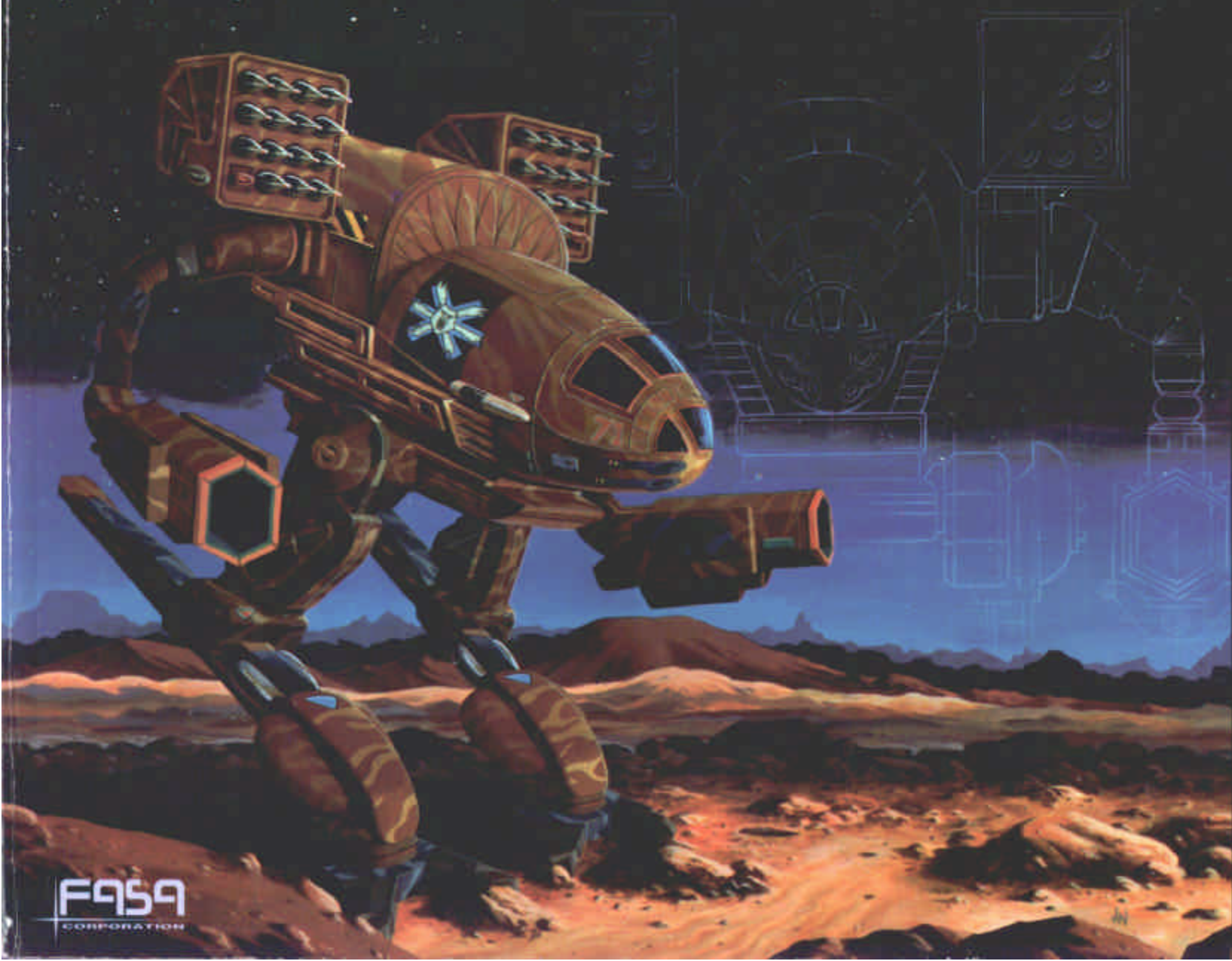

3

BATTLETECH

0

TECHNICAL

5

READOUT:

0

FASA CORPORATION

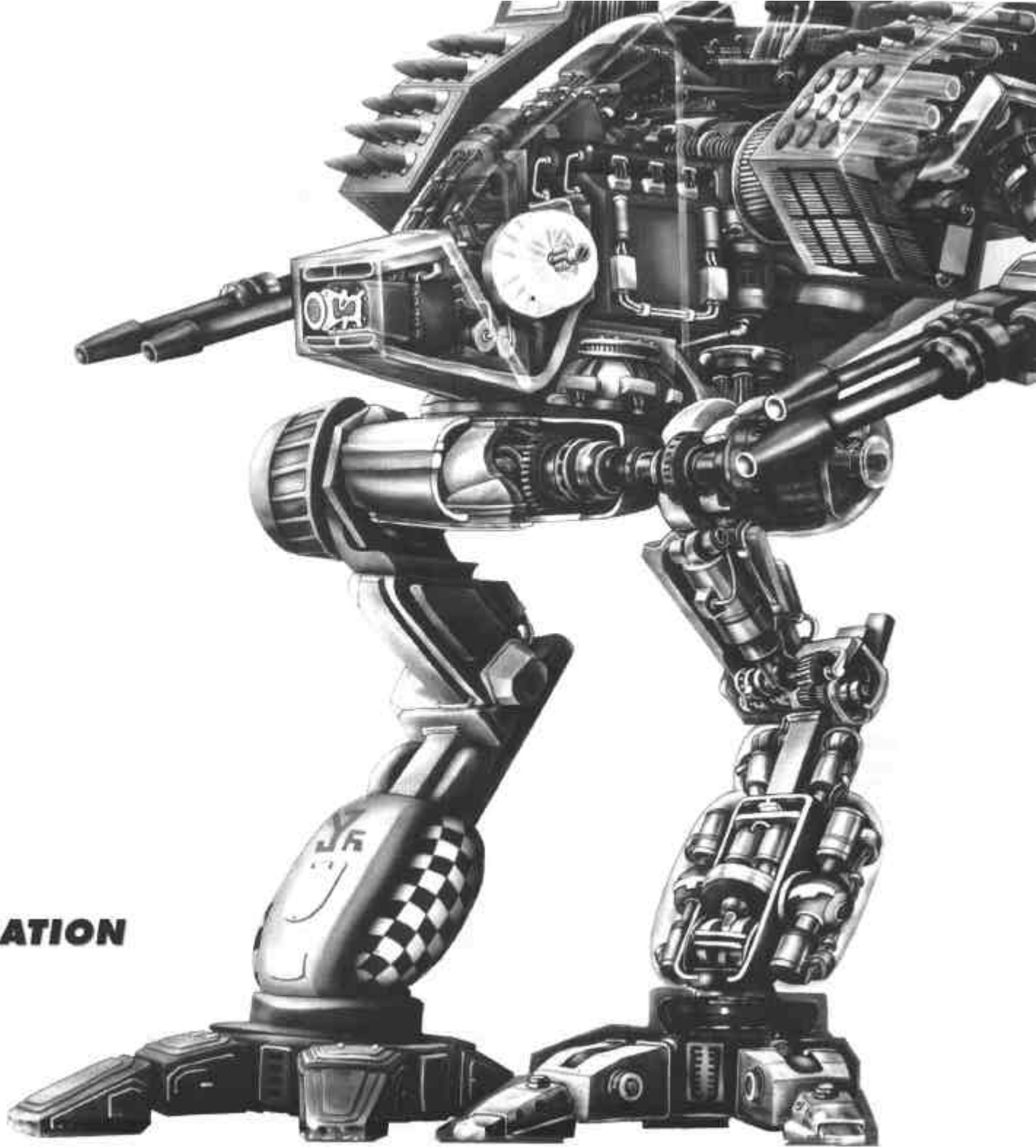

INTRODUCTION	4	Hussar	64	Black Knight	148
THE CLANS	5	Javelin	66	Flashman	150
The Uncommon Common Enemy	6	Spider	68	Orion	152
The Outlaws	6	UrbanMech	70		
Rivalry	6	Firestarter	72	Assault 'Mechs	
Bidding	7	Jenner	74	Awesome	154
Intent	7	Panther	76	Charger	156
Nonmilitary Technology	7	Raven	78	Hatamoto-Chi	158
Organization	7	Wolfhound	80	Thug	160
Tactics	7			Victor	162
Elementals	7	Medium 'Mechs		Zeus	164
OmniMechs	8	Assassin	82	Katana	166
OmniMechs	9	Cicada	84	Shogun	168
Code Name		Clint	86	Stalker	170
Dasher	10	Hermes II	88	Cyclops	172
Koshi	12	Sentinel	90	Highlander	174
Uller	14	Vulcan	92	Mauler	176
Puma	16	Whitworth	94	Banshee	178
Dragonfly	18	Blackjack	96	Annihilator	180
Fenris	20	Hatchetman	98	Atlas	182
Black Hawk	22	Vindicator	100	Imp	184
Ryoken	24	Wolf Trap	102	King Crab	186
Vulture (Hagetaga)	26	Wyvern	104		
Loki	28	Centurion	106	Vehicles	
Thor	30	Crab	108	Gabriel	188
Mad Cat	32	Enforcer	110	Ripper	190
Man o' War	34	Hunchback	112	Beagle	192
Masakari	36	Trebuchet	114	Rotunda	194
Gladiator	38	Dervish	116	Nightshade	196
Daishi	40	Hoplite	118	Cyrano	198
INNER SPHERE RESPONSE	42	Kintaro	120	Lightning	200
Production	42			Zephyr	202
Technology	42	Heavy 'Mechs		Chaparral	204
Strategy	43	Champion	122	Kanga	206
Deployment	44	Grand Dragon	124	Thor	208
Light 'Mechs		Lancelot	126	Demon	210
Name		Quickdraw	128	Marksman	212
Flea	46	Axman	130	Magi	214
Hornet	48	Bombardier	132	Burke	216
Mercury	50	Catapult	134	Fury	218
Thorn	52	Exterminator	136	Rhino	220
Commando	54	JagerMech	138	Puma	222
Mongoose	56	Caesar	140		
Falcon	58	Cataphract	142	Index	224
Firefly	60	Grasshopper	144		
Hermes	62	Guillotine	146		

TECHNICAL READOUT: 3050, REVISED EDITION

ORIGINAL TECHNICAL READOUT: 3050

Writing

J. Andrew Keith
Jim Musser

Development

Sam Lewis

Editorial Staff

Senior Editor
Donna Ippolito
Assistant Editor
Kent Stolt

Playtesters

The Ariston Game Club
Bill Webb Phil Schumer
Christina Laura Lee
Kevin William Dave Brave
Eric J. Smith

Production Staff

Art Director
Jim Nelson
Production Manager
Sam Lewis
Cover
Jim Nelson
Illustration
Joel Biske
Jim Nelson
Dana Knutson
Steve Venters
Layout
Tara Gallagher

REVISED TECHNICAL READOUT: 3050

Original Technical Readout: 2750 material by

Clare W. Hess
Dale L. Kemper
Jim Long
Blaine L. Pardoe
Boy F. Petersen, Jr.

Additional material by

Sam Lewis

BattleTech Line Developer

Bryan Nystul

Development

Bryan Nystul
Randall N. Bills

Editorial Staff

Editorial Director
Donna Ippolito
Managing Editor
Sharon Turner Mulvihill
Associate Editors
Diane Piron-Gelman
Rob Cruz

Editorial assistance by

Karen Stange

Production Staff

Art Director
Jim Nelson
Project Manager
Jim Nelson
Front Cover Art
Jim Nelson
Back Cover Art
C. Sterns
Cover Design
Mike "Skuzzball" Nielsen
B&W Illustration
Joel Biske
Jim Nelson
Dana Knutson
Steve Venters
Layout
John Bridegroom

BATTLETECH®, MECH®, BATTLEMECH®, and MECHWAR-RIOR® are Registered Trademarks of FASA Corporation. BATTLETECH TECHNICAL READOUT: 3050 is a Trademark of FASA Corporation.

Copyright © 1996 FASA Corporation. All Rights Reserved. Printed in the U.S.A.

Published by: FASA Corporation, 1100 W. Cermak Road Suite B305 Chicago, IL 60608

FASA Corporation can be reached on America OnLine (E. Mail—FASALou (Earthdawn), FASAInfo (BattleTech, Shadowrun and General Information) or FASA Art (Art Comments)) in the Online Gaming area (Keyword "Gaming"). Via Inter Net use <AOL Account Name>@AOL.COM, but please, no list or server subscriptions. Thanks!

Visit FASA on the World Wide Web at <http://www.FASA.com>

This manual is intended to assist members of Our Blessed Order who have recently completed their training as Acolytes, bringing them up to date on the events in the outer world. The incredible changes in politics and technology following the Fourth Succession War are nothing compared to the total transformation of the Inner Sphere that has occurred over the past two years. The Successor States are cooperating to a degree unthinkable even three years ago, a powerful new adversary has captured more than 100 worlds, and military technology has run rampant.

The rapid pace of events and even more rapid proliferation of sophisticated weaponry have delayed the issue of this book. Intended for release in 3050, as stated in the title, the book would have been out of date before it reached the hands of its intended readers. Precentor XX-eta Lilith Sebastian wisely ordered wholesale revisions before the volume reached the printer. The cover, unfortunately, could not be called back.

So it is in 3052 that this volume brings our newest Acolytes abreast of the latest BattleMech equipment of all parties in the Inner Sphere, except, of course, Our Blessed Order. Our equipment has not, of course, changed for centuries, and Acolytes make an in-depth study of our military capacities as part of their basic training.

It is important to remember that Clan weapons are superior in performance to those of the Inner Sphere, even though the same terminology is used to discuss the weapons and equipment for both Clans and Inner Sphere. I need not remind you of the terrible consequences should this, or any ComStar document, fall into the hands of anyone outside Our Order.

I am honored that Precentor XX-eta Lilith Sebastian commissioned me to oversee the research and writing of this document. I also thank Precentor Martial Anastasius Focht for his help, especially in the sections on the Clans. The commander of the Com Guards spent many months as envoy to the Clans, and his information and insight have been invaluable. The information about the Inner Sphere response came mostly from the files of Precentor XV-delta Raymond Little, whose assistance helped make this work possible.

It is the hope of all involved with this project that our newest Acolytes will use the information in this book to help achieve our great task of reunifying mankind, according to the Word of Blake.

—Merle Jimmus
Adept XXI-sigma
ComStar Archives, Terra
8 February 3052

Ever since the data vaults of ComStar were opened to the public in the years following Tukayyid, millions of readers have consulted this vital reference work graciously provided by the so-called new ComStar. Our agents have acquired the original files of this document and have discovered startling inconsistencies and omissions. These “mistakes” are clearly attempts by ComStar to conceal its own level of technology and whitewash its checkered past.

In this edition, wherever possible we have made corrections and additions to correct such inaccuracies and omissions. Of particular interest are the various Star League-era 'Mech and vehicle files, which were removed from the original document by ComStar censors. In previous Technical Readouts, ComStar claimed these machines had completely disappeared, victims of the Succession Wars or Kerensky's Exodus. As we now know, many of them are still in service, either with ComStar itself or the Clans, although the Clans relegate such machines to garrison duty. To make space for these additions, other 'Mechs had to be removed by our editors. However, the text of their descriptions needed no alteration, so scholars can still rely on the original data for those aging designs.

—Major-General Margaret Tulliver
Deputy Director, Wolfnet
22 March 3058

GAME NOTES

The BattleMech and vehicle designs contained in this book are constructed using Level 2 **BattleTech** rules. As such, they use advanced weapons and equipment not included in the **BattleTech, Fourth Edition** game. Rules for the use of this equipment can be found in **CityTech, Second Edition** and the **BattleTech Compendium: The Rules of Warfare**. Those products also contain the rules for the use of Elementals, as well as other types of infantry.

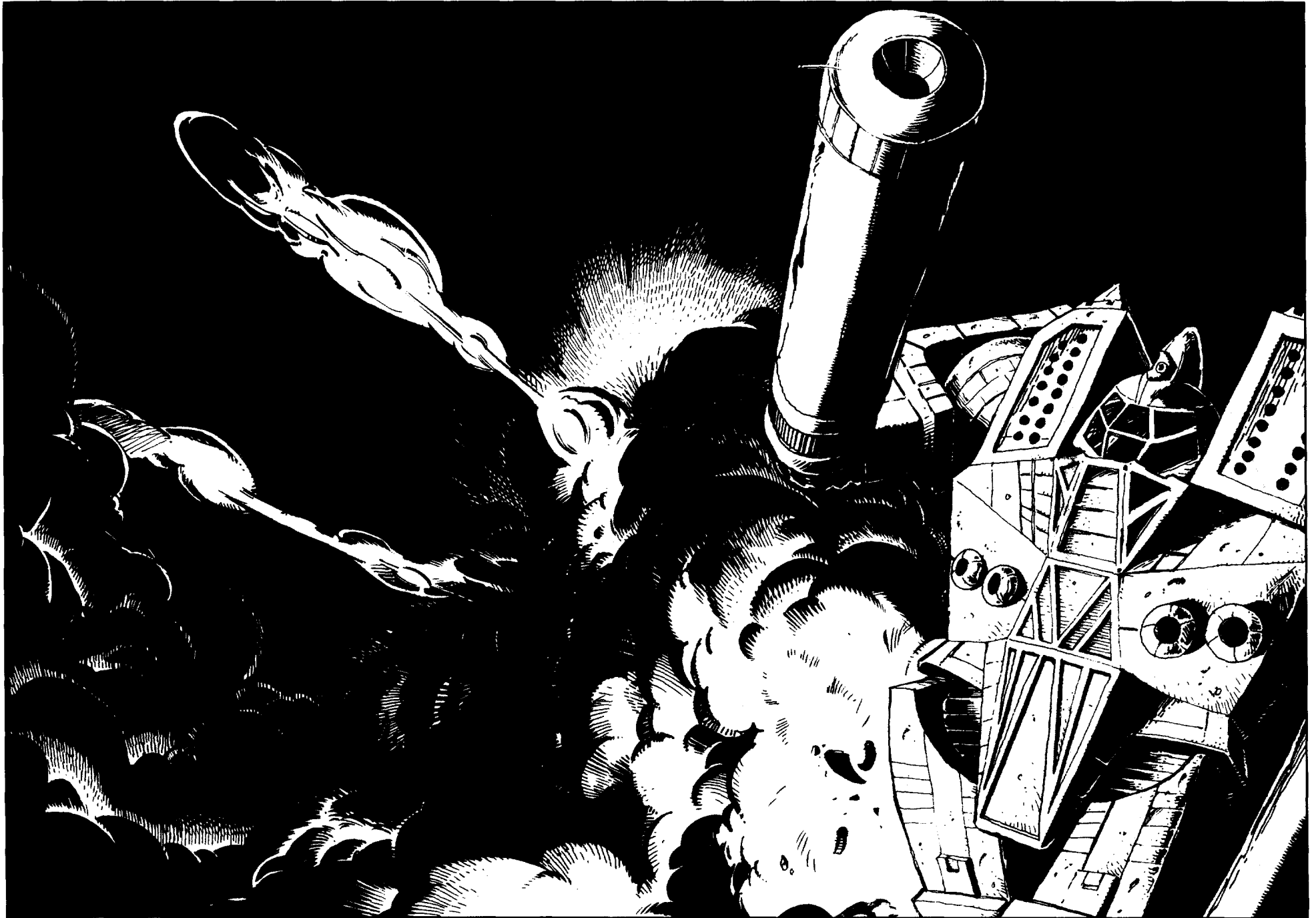

From the final days of 3049 and continuing into 3050, the shape of the Inner Sphere began to change. From beyond the Periphery came the Jade Falcons, the Wolves, the Smoke Jaguars, and the Ghost Bears, invading Warrior Clans who easily pushed aside the defending armies in their way. In less than a year, the Clans seized more than 100 worlds from the Successor States.

For 250 years, the House Lords had fought amongst themselves in the endless conflict known as the Succession Wars. Many people died, a few worlds changed hands, and the level of technology degenerated. For all the fighting and the dying, little changed from the time General Aleksandr Kerensky took the Star League Regular Army with him into the unknown until 13 August 3049, the day the Inner Sphere came in contact with the Clan juggernaut.

With their superior war machines, strange practices and superhuman infantry, these invaders were thought to be an alien species come to conquer humanity. A year later, we know the Clans are human, but their practices are so strange to us that they are almost as alien as another species.

For months, the Clans were unstoppable. Even crack units fell before them. In the occasional incidents when the Clans skirmished with the Com Guards by mistake, even our sophisticated 'Mechs could do little against the invaders. One of the first and best Inner Sphere regiments to fall to the Clans was the elite Seventeenth Skye Rangers, victims of the Jade Falcons' first-wave strike at Barcelona.

A list of units destroyed or seriously disrupted by the Clans is impressive.

THE OUTLAWS

With their advance into the Inner Sphere, it must be assumed that the Clans have already conquered the known entities in this area of the Periphery—the

DESTROYED UNITS

Federated Commonwealth

1st Lyran Regulars
2nd New Ivaarsen Chasseurs
8th Arcturan Guards RCT
10th Donegal Guards RCT
12th Donegal Guards RCT
17th Skye Rangers
24 Arcturan Guards RCT
41st Avalon Hussars RCT
Hot Springs Tamar March Militia
Somerset Academy Training Battalion
Twycross Tamar March Militia
Winfield's Regiment
Wotan Tamar March Militia

Draconis Combine

1st Alshain Regulars
3rd Alshain Regulars
4th Pesht Regulars
9th Alshain Regulars
9th Pesht Regulars
14th Legion of Vega

Free Rasalhague Republic

1st Drakøns
1st Freeman
1st Husars
1st Kavelleri
2nd Drakøns
3rd Freeman
3rd Kavelleri

Mercenary Units

1st Kell Hounds (3rd Battalion)
12th Star Guards (four regiments)
Black Omen
Glory Warriors
Grave Walkers (two regiments)
Skinner's Scimitar

Oberon Confederation, Elysian Fields, the Greater Valkyrate, Star's End, Santander V and Porthos.

The Clans appear to be inconsistent in their behavior toward the conquered people once they have captured worlds. They use some of their captives as slaves, while others continue their lives as if no change had occurred. The Clans do not interfere with the activities of Our Blessed Order, yet never make use of our services. They sometimes consult with our adepts and preceptors on treatment of civilians. At times they are magnanimous; at others they are savage, killing millions from space with their WarShips as they did at Edo on Turtle Bay.

The Clans met their first defeats at the hands of the Draconis Combine on Wolcott and the Federated Commonwealth on Twycross. Combined with the destruction of their flagship and leader at the hands of a Rasalhagian aerospace pilot, these events have put the brakes on the Clans' invasion. They have made no new attacks for months, and there are indications that

their front-line units have left the Inner Sphere, presumably to regroup while garrison troops protect their holdings.

RIVALRY

The Clans each have their own areas, and they are in apparent competition to advance the quickest. Wholly in the Federated Commonwealth are the Jade Falcons. Attacking along the Lyran-Rasalhague border is the Wolf Clan. On the other side of the Free Rasalhague Republic and into the Draconis Combine are the Ghost Bears. Attacking totally within the Draconis Combine are the Smoke Jaguars. The Wolves have been advancing the most quickly, the Bears the slowest.

The competition—which would seem like a sport if it were not so deadly and intense—exists not only among the different Clans, but also within each Clan. Clan warriors

compete for the right to finish off an enemy, practicing an unusual form of one-upmanship by trying to accomplish a task with the smallest force possible.

BIDDING

One of the most peculiar aspects of the Clans' warrior society is that they actually bid with one another for the right to destroy the Inner Sphere's armies. When a world, like Rasalhague, lies on the seam between the areas of two competing Clans, they bid for the privilege of attacking the world. Whichever Clan vows to accomplish the task with the smallest commitment of warriors and equipment draws the assignment.

The Clans estimate the enemy's strength with a straightforward process that has never been tried before: they ask. Before attacking each world, the Clans request that the defenders tell them what units are protecting the planet and their histories and disposition. The attacking Clan then sets its officers against each other to bid for the right to lead the invasion.

Whoever promises to take the planet with the fewest forces gets the task. That commander can still call on the full number of troops of his first bid, but to do so would be a great loss of face. The Clans generally commit about half the number of 'Mechs as the defending force.

INTENT

The Clans' motivation in attacking the Inner Sphere has been the subject of much conjecture. Though they have been open with Precentor Martial Anastasius Focht on military matters, they have been less so on subjects that might be considered political or social. The Precentor Martial reports hearing vague references to a massive migration following the invading forces, but so far the Clan leaders have denied this.

The invasion ships were clearly composed of all warriors and support personnel. There were no civilians aboard. With the lull in fighting and apparent withdrawal of the shock troops, the invading forces are apparently making new plans, or gathering new strength. In either event, the Inner Sphere has not seen the last of the Clans, but the House Lords still do not know what drives these strange people.

NONMILITARY TECHNOLOGY

Not only are the Clans advanced militarily, they also possess other sophisticated science, notably in the area of medicine. The Precentor Martial has reported amazing cases where advanced medical techniques have kept severely injured people alive, and then brought them back from the brink of death.

One member of the Clans even mentioned that they could have saved the Precentor Martial's lost eye if they had been there at the time. He has also reported amazing cases in which an artificial skin seals a wound and actually administers medicine automatically. Their spaceships apparently are lined with a similar substance that seals holes in the hull.

ORGANIZATION

The basic element of the Clan military is called a Point, consisting of a 'Mech, or two aerospace fighters, or five infantrymen. Five Points constitute a Star. Unlike Inner Sphere organization, which groups 'Mechs of similar weights together, the Clans often mix dissimilar Points to make up a Star. Infantry and 'Mechs frequently fight as part of the same team.

Groups of Stars are called Clusters. Though the Clans' total strength is unknown, Precentor Martial Anastasius Focht reported that there were 15 Stars aboard the ship on which he traveled, the Wolf Clan's flagship, the *Dire Wolf*.

The Clans use various colored stars and shield insignia to differentiate among the military arms of their forces. These distinctions are not completely clear as yet. Another organizational term that the Clans use is *sibko*, though this may be a term of social organization rather than military organization.

TACTICS

Tactically, the Clans fight much differently from the armies of the Inner Sphere. Their attacks are direct, with little deception. Theirs is a strategy born from the confidence of superior equipment. Using less than all the forces available is a concept foreign to the Successor States, though the Draconis Combine's tradition of honor comes the closest in practice.

This also manifests itself differently on the battlefield. The long-accepted practice of concentrating fire on a single enemy 'Mech appears to be unknown to the Clans. Each Clan warrior selects his own target, and it appears to be dishonorable to allow another warrior to help in a kill.

OMNIMECHS

The Clans' success is certainly due to a number of factors, including their powerful WarShips, but none is more important than the OmniMech. The technological advances beyond what the Successor States are just beginning to field would have been quite sufficient to put the Inner Sphere on the run without the concept of the OmniMech.

These designs feature modular weapons and other equipment, which has several advantages. One of the primary benefits is the ability to tailor the 'Mech for its expected mission. Thus, the same 'Mech that provided fire support on Tuesday can wade in among the urban sappers on Wednesday with no loss of effectiveness.

The other big advantage is the reduction in time required for repair and maintenance. If a 'Mech's arm is blown off, replacing it is a simple matter. If a particular weapon is acting up, the 'Mech simply carries a different one while the techs work on the problem safely behind the lines. The entire 'Mech seldom needs to be taken out of service for maintenance because most of its parts are modular and can be serviced independently.

Though it may seem a minor point to military planners, yet another advantage of the OmniMech is that it can be outfitted to reflect pilot preference. This may seem insignificant, but MechWarriors often perform better using certain kinds of weapons.

The 16 designs described on the following pages are the only ones seen so far, but we are not prepared to assume that there are no more. We also have made no attempt to list the Clans' second-line 'Mechs because they are designs similar to those of the Inner Sphere, albeit with superior weapons.

ELEMENTALS

One of the most revolutionary features of the Clans' military is their battle armor. Worn by giant Elementals, men and women bred to be foot soldiers, these suits are unlike anything ever seen in the Inner Sphere.

Victor Ian Steiner-Davion labeled them Toads, but their hard shell and nasty sting makes them more like persistent insects. The first MechWarriors to face these Elementals were astounded when their machine gun fire had no effect. When the Elementals then withstood a direct hit from a medium laser, it is no wonder the Inner Sphere warriors thought they were fighting an alien life form.

The suit itself is a marvel. It can take tremendous punishment before enemy weapons can make a breach. When a powerful weapon does get through the armor, a healing substance inside the suit seals off the opening, covers the Elemental's wound, and administers drugs. These drugs are so powerful that they keep the Elemental alive and in fighting condition, as well. The armor also apparently enhances the Elemental's great strength, allowing a foot soldier to rip sheets of armor off a 'Mech with his hands.

The Elementals have far more powerful weapons at their disposal, however. They can jump significant distances, keeping the enemy off balance. The typical arrangement is for the Elemental to carry a small laser in his right arm, a machine gun in his left, and a detachable short-range missile launcher on his back.

These hard-to-hit troops can destroy a 'Mech with no help from their big brothers.

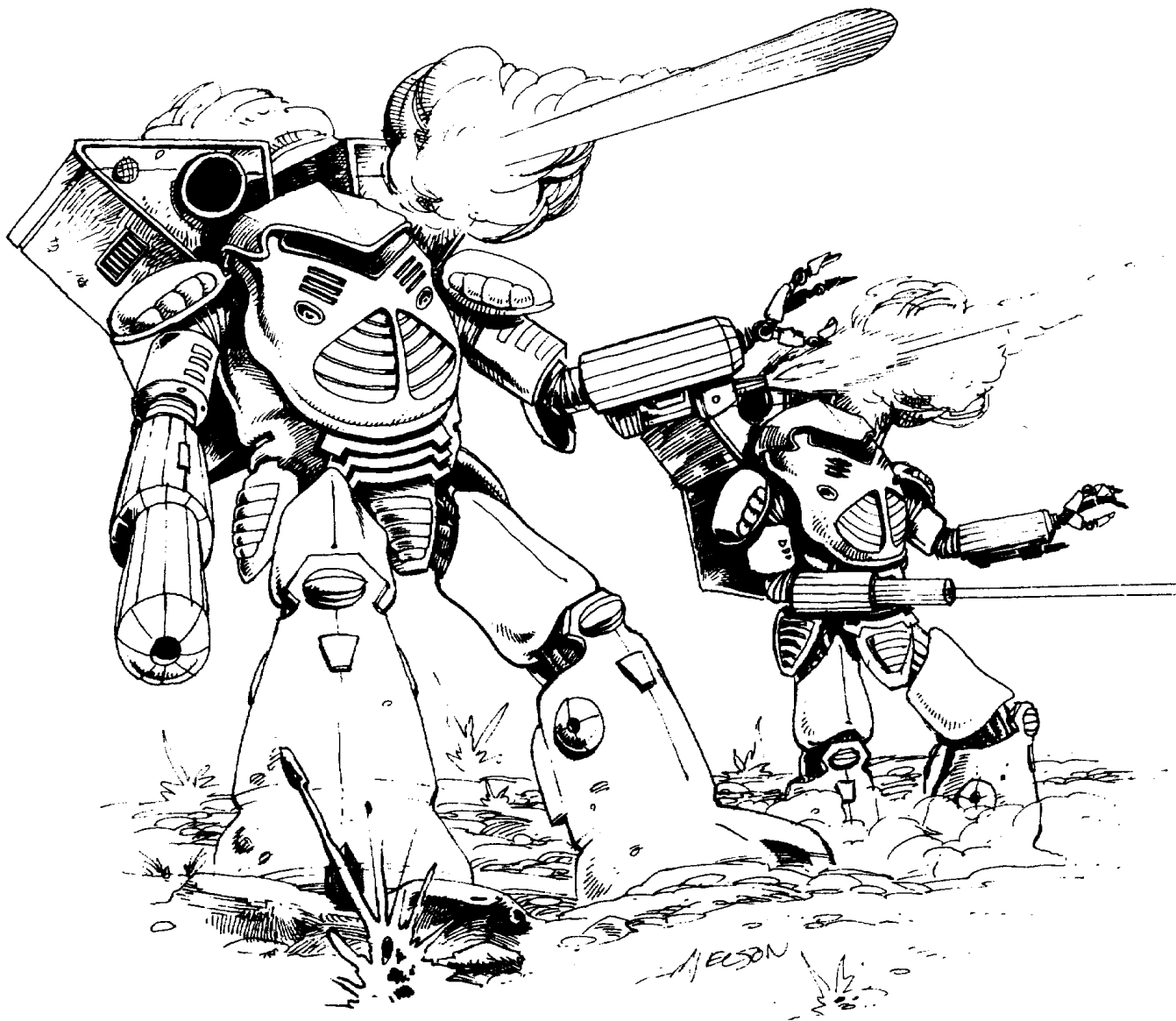

THE UNCOMMON COMMON ENEMY

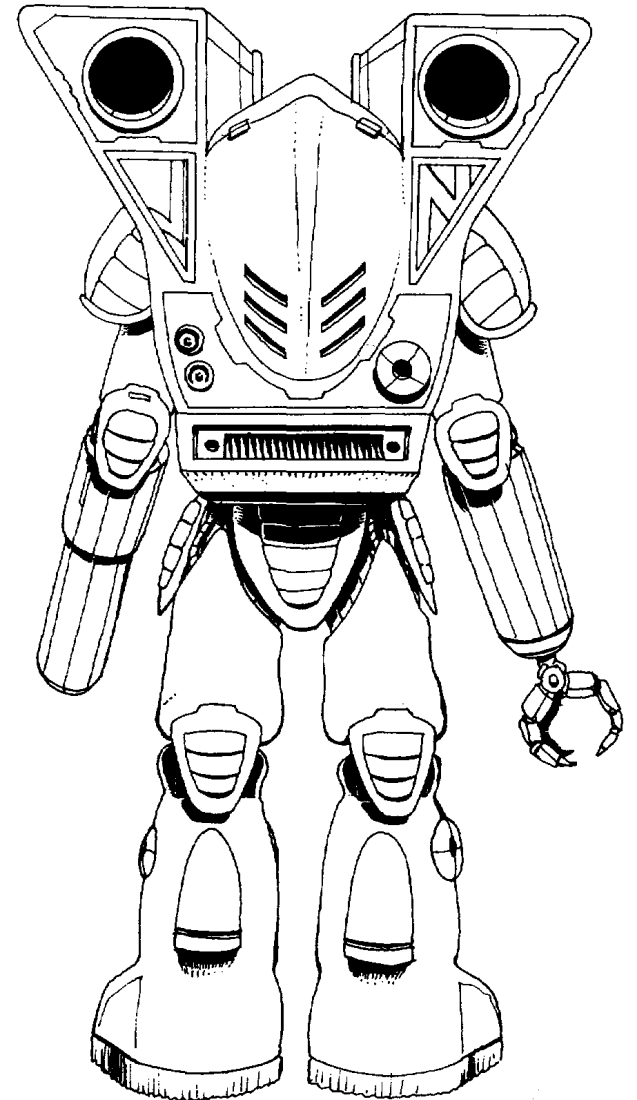
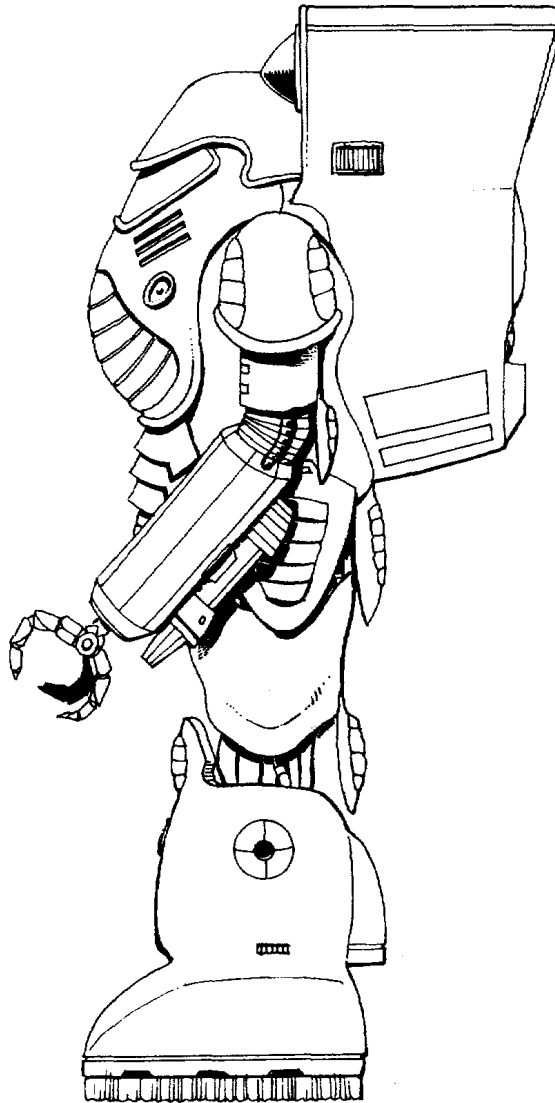
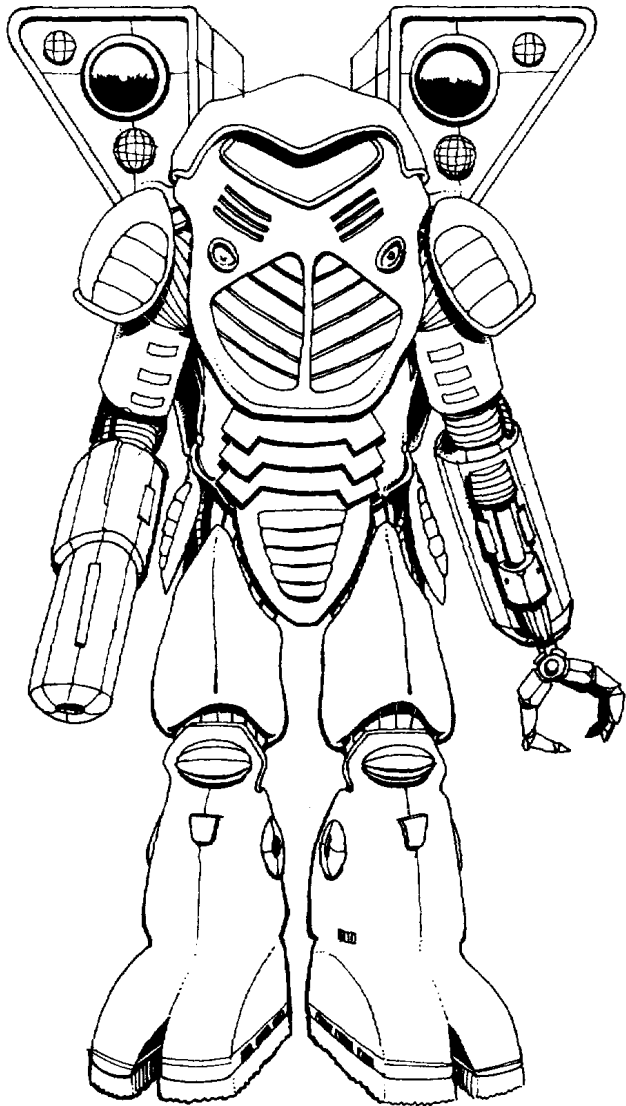

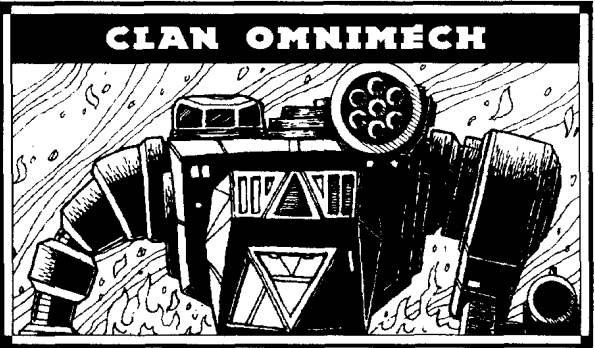

OVERVIEW

Code-named the *Dasher* by the Royal KungsArmé because of its incredible bursts of speed, this 'Mech is unlike any ever produced in the Inner Sphere, during the Star League era or since. It carries a load of weapons that is ample for a light 'Mech produced in the Inner Sphere, despite being smaller than any other Clan 'Mech yet seen in the field. An excellent reconnaissance 'Mech because of its quick pace, the *Dasher* can get out of a tight spot by engaging its Myomer Accelerator Signal Circuitry. Its armor is thin, but the *Dasher* is so fast that it is difficult to hit.

CAPABILITIES

In its primary configuration, the *Dasher* can give a good account of itself against light 'Mechs of the Inner Sphere. Its exceptional speed allows it to get into close range regardless of its opponent's actions, and use its short-range missiles and medium lasers to good effect. If facing a larger enemy, the *Dasher* simply retreats to friendly lines, leaving its foe far behind. Another popular tactic is for the *Dasher* to race to the enemy's rear, cutting down opposing 'Mechs before they can respond. This has worked out badly on occasion, primarily because of the Rasalhagian practice of forming lances into a column. On several occasions, a *Dasher* has sped around a light 'Mech, only to be cut down by a medium 'Mech following several hundred meters behind.

Alternate Configuration A has been seen only on rare occasions, but has been used to devastating effect. This configuration uses its Beagle active probe to locate hidden enemy positions and its target-acqui-

sition gear to rain down flights of Arrow IV missiles from other members of its Cluster many kilometers away. It uses its Streak short-range missiles and anti-missile system to hold its place on the battlefield for as long as possible, then returns to the supporting 'Mechs in its unit with amazing speed.

Using its Guardian electronic countermeasures to protect its Starmates, a *Dasher* equipped with Alternate Configuration B leads a force into an enemy city or other built-up area where hostilities are expected. Its medium pulse lasers and machine guns can swiftly destroy enemy infantry, and the A-pod helps keep sappers off the 'Mech's legs.

In Alternate Configuration C, the *Dasher* performs long-range fire support, a role for which it is not particularly well-suited. Though it carries double LRM-5 launchers and an anti-missile system to protect itself from return fire, it cannot carry nearly as many weapons as other Clan designs. However, no 'Mech can fall back to a new position as quickly as the *Dasher*.

When the Clans expect to mix it up with other 'Mechs and have no other concern, they equip the *Dasher* with Alternate Configuration D. Though this variant occasionally has a problem with heat build-up, it can deliver an accurate and deadly hail of laser fire at opposing 'Mechs.

DEPLOYMENT

The *Dasher* is one of the less common Clan designs, not in general use because of the specialized roles it plays. It is seen most frequently among the forces of Clan Ghost Bear, who favor it over other reconnaissance 'Mechs.

- Mass:** 20 tons
- Chassis:** Endo Steel
- Power Plant:** 200 XL
- Cruising Speed:** 108 kph
- Maximum Speed:** 162 kph, 216 kph w/ MASC
- Jump Jets:** None
- Jump Capacity:** None
- Armor:** Ferro-Fibrous
- Armament:** 6.5 tons of pod space available
- Manufacturer:** Unknown
- Communications System:** Unknown
- Targeting and Tracking System:** Unknown

Type: **Fire Moth**
 Inner Sphere Designation: **Dasher**
 Technology Base: Clan OmniMech
 Tonnage: 20

Equipment		Mass
Internal Structure:	Endo	1
Engine:	200 XL	4.5
Walking MP:	10	
Running MP:	15 (20)	
Jumping MP:	0	
Heat Sinks:	10 [20]	0
Gyro:		2
Cockpit:		3
Armor Factor:	38	2
	<i>Internal Structure</i>	<i>Armor Value</i>
Head	3	5
Center Torso	6	5
Center Torso (rear)		2
R/L Torso	5	4
R/L Torso (rear)		2
R/L Arm	3	3
R/L Leg	4	4

Weight and Space Allocation

Location	Fixed	Spaces Remaining
Head	1 Ferro-Fibrous	0
Center Torso	1 MASC 1 Endo Steel	0
Right Torso	2 XL Engine Double Heat Sink 1 Endo Steel 2 Ferro-Fibrous	5
Left Torso	2 XL Engine Double Heat Sink 1 Endo Steel 2 Ferro-Fibrous	5
Right Arm	1 Endo Steel 1 Ferro-Fibrous	6
Left Arm	1 Endo Steel 1 Ferro-Fibrous	6
Right Leg	1 Endo Steel	1
Left Leg	1 Endo Steel	1

Weapons and Ammo Location Critical Tonnage

Primary Weapons Configuration				
ER Medium Laser	LA	1	1	
ER Medium Laser	LA	1	1	
SRM 6	RA	1	1.5	
Ammo (SRM) 15	RA	1	1	
SRM 4	RT	1	1	
Ammo (SRM) 25	RT	1	1	

Weapons and Ammo Location Critical Tonnage
Alternate Configuration A

Anti-Missile System	LA	1	.5
Ammo (Anti-Missile) 24	LA	1	1
TAG	RA	1	1
Active Probe	RA	1	1
Streak SRM 4	RT	1	2
Ammo (Streak) 25	RT	1	1

Alternate Configuration B

Medium Pulse Laser	LA	1	2
ECM Suite	RA	1	1
Machine Gun	RA	1	.25
Machine Gun	RA	1	.25
Ammo (MG) 100	RA	1	.5
A-Pod	RL	1	.5
Medium Pulse Laser	RT	1	2

Alternate Configuration C

LRM 5	LA	1	1
Ammo (LRM) 24	LA	1	1
LRM 5	RA	1	1
Ammo (LRM) 24	RA	1	1
Anti-Missile System	RT	1	.5
Ammo (Anti-Missile) 48	RT	2	2

Alternate Configuration D

ER Medium Laser	LA	1	1
ER Medium Laser	LA	1	1
ER Medium Laser	RA	1	1
ER Medium Laser	RA	1	1
ER Medium Laser	RT	1	1
Targeting Computer	RT	1	1
Flamer	RT	1	.5

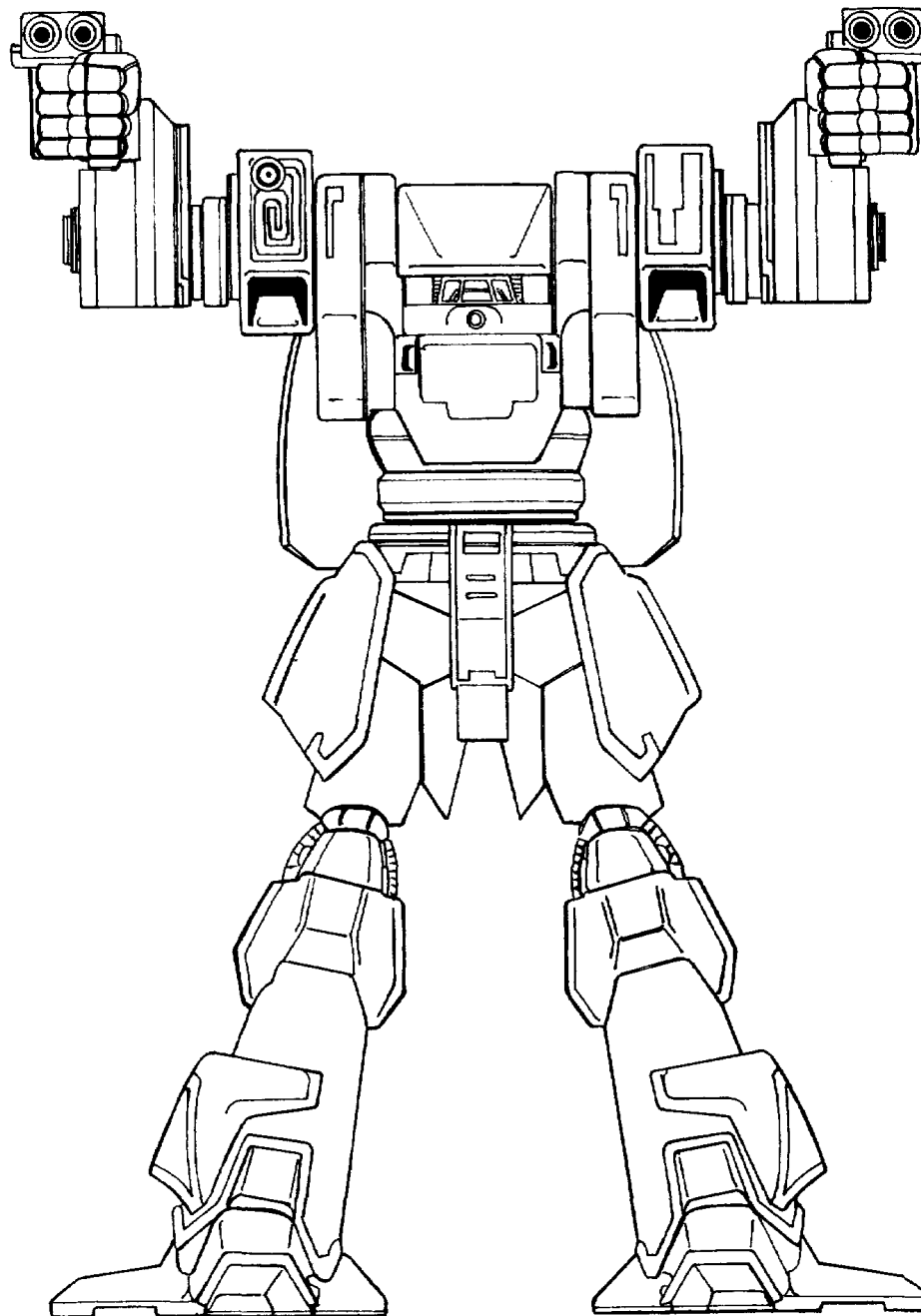

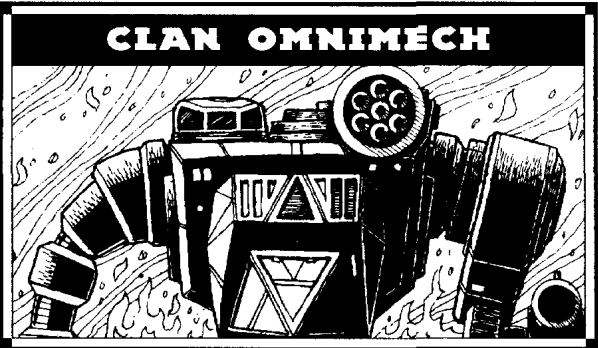

OVERVIEW

With enough firepower to defeat other reconnaissance 'Mechs and enough speed to outrun almost everything else, the *Koshi* is a valuable addition to any army. This 'Mech's Japanese name, reportedly coined by a member of the Draconis Combine's criminal element, translates roughly as "small death," a term without clear meaning in English. The *Koshi* often leads a reconnaissance Star, but it is sometimes attached as the light element to a heavier unit. The Beagle active probe appears to be fixed equipment on the *Koshi*, meaning that it is rare to see two of these 'Mechs serving together.

CAPABILITIES

In its most common configuration, the *Koshi* can serve in many roles. Combined with its excellent reconnaissance abilities, it has long-range striking power, a potent short-range weapon, and two machine guns to deal with infantry. This 'Mech's deadly effect on infantry may have been what earned it the name *Small Death*.

Occasionally used as a combination anti-personnel weapon and artillery spotter, the *Koshi-A* sometimes marches into battle with an unusual weapons mix. Carrying target acquisition gear to spot for friendly 'Mechs and vehicles equipped with Arrow IV missiles, this *Koshi* also has equipment to shield it from all manner of enemy activity. It has an unusual dual anti-missile system in its left arm, with enough ammunition to stay on the battlefield forever. Its combination of double A-pods, machine gun and flamer give enemy infantry no hope of attacking the *Koshi*.

In Configuration B, the *Koshi* packs considerably more firepower. Its left arm carries two medium lasers as softening-up weapons, with the follow-up wallop of double SRM-6 launchers on its right arm. The right arm also carries a small laser.

The *Koshi* is also sometimes outfitted as an electronic marvel. Configuration C combines the fixed active probe with an added Guardian ECM system that lets the *Koshi* get the jump on any enemy. An anti-missile system adds to its defenses, while the right arm carries an extended-range large and medium laser.

Though rarely seen, Configuration D of the *Koshi* reportedly carries an Ultra-2 autocannon, a weapon not in wide use among the Clans. Also carrying an extended-range medium and small laser, this version can be more useful than the others in some situations, but those occasions are notoriously difficult to predict.

DEPLOYMENT

The *Koshi* has been spotted with all four warrior Clans, but it is prevalent only among the Smoke Jaguars. The Jaguars have used it to good effect against the Draconis Combine, though it is rumored that Gunji no Kanrei Theodore Kurita has captured one, along with several other designs.

- Mass:** 25 tons
- Chassis:** Endo Steel
- Power Plant:** 175 XL
- Cruising Speed:** 75.6 kph
- Maximum Speed:** 118.8 kph
- Jump Jets:** 6
- Jump Capacity:** 180 meters
- Armor:** Ferro-Fibrous
- Armament:** 7.5 tons of pod space available
- Manufacturer:** Unknown
- Communications System:** Unknown
- Targeting and Tracking System:** Unknown

Type: **Mist Lynx**
 Inner Sphere Designation: **Koshi**
 Technology Base: Clan OmniMech
 Tonnage: 25

Equipment		Mass
Internal Structure:	Endo	1.5
Engine:	175 XL	3.5
Walking MP:	7	
Running MP:	11	
Jumping MP:	6	
Heat Sinks:	10 [20]	
Gyro:		2
Cockpit:		3
Armor Factor:	67	3.5
	<i>Internal Structure</i>	<i>Armor Value</i>
Head	3	9
Center Torso	8	10
Center Torso (rear)		6
R/L Torso	6	7
R/L Torso (rear)		5
R/L Arm	4	4
R/L Leg	6	5

Weight and Space Allocation

Location	Fixed	Spaces Remaining
Head	1 Active Probe	0
Center Torso	1 Endo Steel	0
	1 Ferro-Fibrous	
Right Torso	2 XL Engine	2
	Double Heat Sink	
	3 Jump Jets	
	1 Endo Steel	
Left Torso	2 Ferro-Fibrous	
	2 XL Engine	0
	2 Double Heat Sinks	
	3 Jump Jets	
	1 Endo Steel	
	2 Ferro-Fibrous	
Right Arm	1 Endo Steel	6
	1 Ferro-Fibrous	
Left Arm	1 Endo Steel	6
	1 Ferro-Fibrous	
Right Leg	1 Endo Steel	1
Left Leg	1 Endo Steel	1

Weapons and Ammo Location Critical Tonnage
Primary Weapons Configuration

LRM 10	LA	1	2.5
Ammo (LRM) 12	LA	1	1
Streak SRM 4	RA	1	2
Ammo (Streak) 25	RA	1	1
Machine Gun	RA	1	.25
Machine Gun	RA	1	.25
Ammo (MG) 100	RA	1	.5

Alternate Configuration A

TAG	LA	1	1
Anti-Missile System	LA	1	.5
Anti-Missile System	LA	1	.5
Ammo (Anti-Missile) 72	LA	3	3
A-Pod	LL	1	.5
Flamer	RA	1	.5
Machine Gun	RA	1	.25
Machine Gun	RA	1	.25
Ammo (MG) 100	RA	1	.5
A-Pod	RL	1	.5

Alternate Configuration B

ER Medium Laser	LA	1	1
ER Medium Laser	LA	1	1
SRM 6	RA	1	1.5
SRM 6	RA	1	1.5
Ammo (SRM) 30	RA	2	2
ER Small Laser	RA	1	.5

Alternate Configuration C

ECM Suite	LA	1	1
Anti-Missile System	LA	1	.5
Ammo (Anti-Missile) 24	LA	1	1
ER Large Laser	RA	1	4
ER Medium Laser	RA	1	1

Alternate Configuration D

Ultra AC/2	LA	2	5
Ammo (Ultra) 45	LA	1	1
ER Medium Laser	RA	1	1
ER Small Laser	RA	1	.5

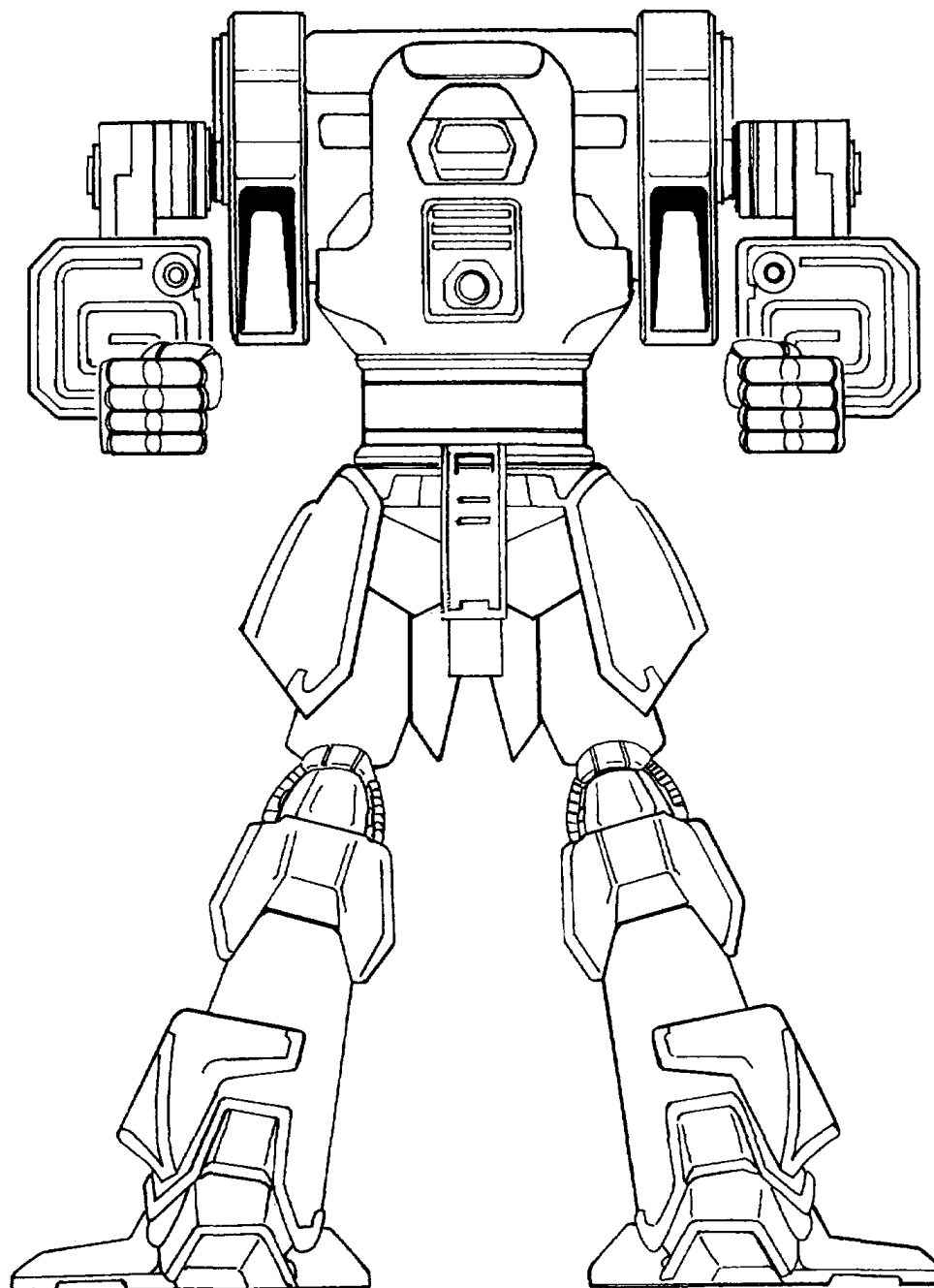



OVERVIEW

The *Uller*, named for the Norse god of archery, is an exceptionally versatile light 'Mech. In its main configuration, the *Uller* carries a mix of weapons that gives it striking power at all ranges while avoiding the problems associated with reliance on a single weapons system. Reasonably fast and well armored for its size, this design can hold its own against many of the Inner Sphere's medium 'Mechs.

CAPABILITIES

In its primary configuration, the *Uller* combines four of the Clans' most advanced weapons. Its main firepower comes from the LB 5-X autocannon in its right arm and the extended-range large laser in its left. A small pulse laser and Streak SRM 4 add to the *Uller's* punch at close range. This design keeps heat buildup in check, economizes on missile loads to avoid running out of ammunition, and provides sting at varying ranges.

Though the Successor States have come to expect surprises from the Clans, the *Uller* still caught the Federated Commonwealth off guard the first time it appeared in Alternate Configuration A. No one expected a light 'Mech to carry such a powerful and bulky weapon as a Gauss rifle. This weapon can cripple an opposing light 'Mech with a single shot. Though this configuration also contains two extended-range medium lasers, it lacks the versatility of the primary configuration and so appears far less often on the battlefield.

Alternate Configuration B is similar in appearance and performance to the primary configuration, but with a few significant differences. It carries an SRM-6 in

place of the Streak SRM-4, a larger autocannon, and two extended-range lasers, surprising Inner Sphere MechWarriors who faced it believing they knew this 'Mech's capabilities. Because Configuration B is so similar in appearance to the primary version, we cannot be certain how frequently the B variant is used.

Configuration C is a specialized machine, designed for densely populated areas. Its sophisticated electronics allow it to spot a hidden enemy, call in devastating missile artillery, and jam enemy tracking computers all at the same time. Its double machine guns and double A-pods are effective against enemy infantry who get too close, and its exceptional triple anti-missile system can swat down incoming missiles from several enemy 'Mechs simultaneously. This version of the *Uller* carries only two offensive weapons: an extended-range large laser and a small pulse laser.

The *Uller* sometimes acts as long-range fire support in Alternate Configuration D. Sporting three long-range missile launchers and a Narc missile beacon for enhanced accuracy, the *Uller* can lend its Starmates some sting from afar. The obvious drawbacks to this design are its reliance on limited ammunition and its inability to deal with an enemy at close range.

DEPLOYMENT

The primary light 'Mech of the Jade Falcons, the *Uller* has become a familiar sight in the Twycross Command. Because other light 'Mechs are quicker, the *Uller* sees less reconnaissance duty than some other models. It is also uncommon among the other Clans, who appear to prefer speedier 'Mechs for scouting and heavier designs for everything else.

Mass: 30 tons

Chassis: Endo Steel

Power Plant: 180 XL

Cruising Speed: 64.8 kph

Maximum Speed: 97.2 kph

Jump Jets: None

Jump Capacity: None

Armor: Ferro-Fibrous

Armament:

16 tons of pod space available

Manufacturer: Unknown

Communications System: Unknown

Targeting and Tracking System: Unknown

Type: **Kit Fox**

Inner Sphere Designation: **Uller**

Technology Base: Clan OmniMech

Tonnage: 30

Equipment		Mass
Internal Structure:	Endo	1.5
Engine:	180 XL	3.5
Walking MP:	6	
Running MP:	9	
Jumping MP:	0	
Heat Sinks:	10 [20]	
Gyro:		2
Cockpit:		3
Armor Factor:	77	4
	<i>Internal Structure</i>	<i>Armor Value</i>
Head	3	9
Center Torso	10	9
Center Torso (rear)		5
R/L Torso	7	8
R/L Torso (rear)		4
R/L Arm	5	7
R/L Leg	7	8

Weight and Space Allocation

Location	Fixed	Spaces Remaining
Head	1 Ferro-Fibrous	0
Center Torso	Double Heat Sink	0
Right Torso	2 XL Engine 3 Endo Steel 2 Ferro-Fibrous	5
Left Torso	2 XL Engine 2 Double Heat Sinks 2 Endo Steel 2 Ferro-Fibrous	2
Right Arm	1 Endo Steel 1 Ferro-Fibrous	6
Left Arm	1 Endo Steel 1 Ferro-Fibrous	6
Right Leg		2
Left Leg		2

Weapons and Ammo Location Critical Tonnage

Primary Weapons Configuration

ER Large Laser	LA	1	4
Small Pulse Laser	LA	1	1
Streak SRM 4	RA	1	2
Ammo (Streak) 25	RA	1	1
LB 5-X AC	RA	4	7
Ammo (LB-X) 20	RA	1	1

Weapons and Ammo Location Critical Tonnage

Alternate Configuration A

Gauss Rifle	RA	6	12
Ammo (Gauss) 16	RA	2	2
ER Medium Laser	LA	1	1
ER Medium Laser	LA	1	1

Alternate Configuration B

ER Medium Laser	LA	1	1
ER Small Laser	LA	1	.5
SRM 6	RA	1	1.5
Ammo (SRM) 15	RA	1	1
Ultra AC/10	RA	4	10
Ammo (Ultra) 20	RT	2	2

Alternate Configuration C

Machine Gun	LA	1	.25
Machine Gun	LA	1	.25
Ammo (MG) 200	LT	1	1
ER Large Laser	LA	1	4
Small Pulse Laser	LA	1	1
Anti-Missile System	RA	1	.5
Anti-Missile System	RA	1	.5
Anti-Missile System	RA	1	.5
Ammo (Anti-Missile) 96	RT	4	4
Active Probe	RA	1	1
TAG	RA	1	1
ECM Suite	RA	1	1
A-Pod	RL	1	.5
A-Pod	LL	1	.5

Alternate Configuration D

LRM 15	LA	2	3.5
Ammo (LRM) 16	LA	2	2
LRM 5	LA	1	1
Ammo (LRM) 24	LT	1	1
LRM 15	RA	2	3.5
Ammo (LRM) 16	RT	2	2
Narc Missile Beacon	RA	1	2
Ammo (Narc) 6	RT	1	1

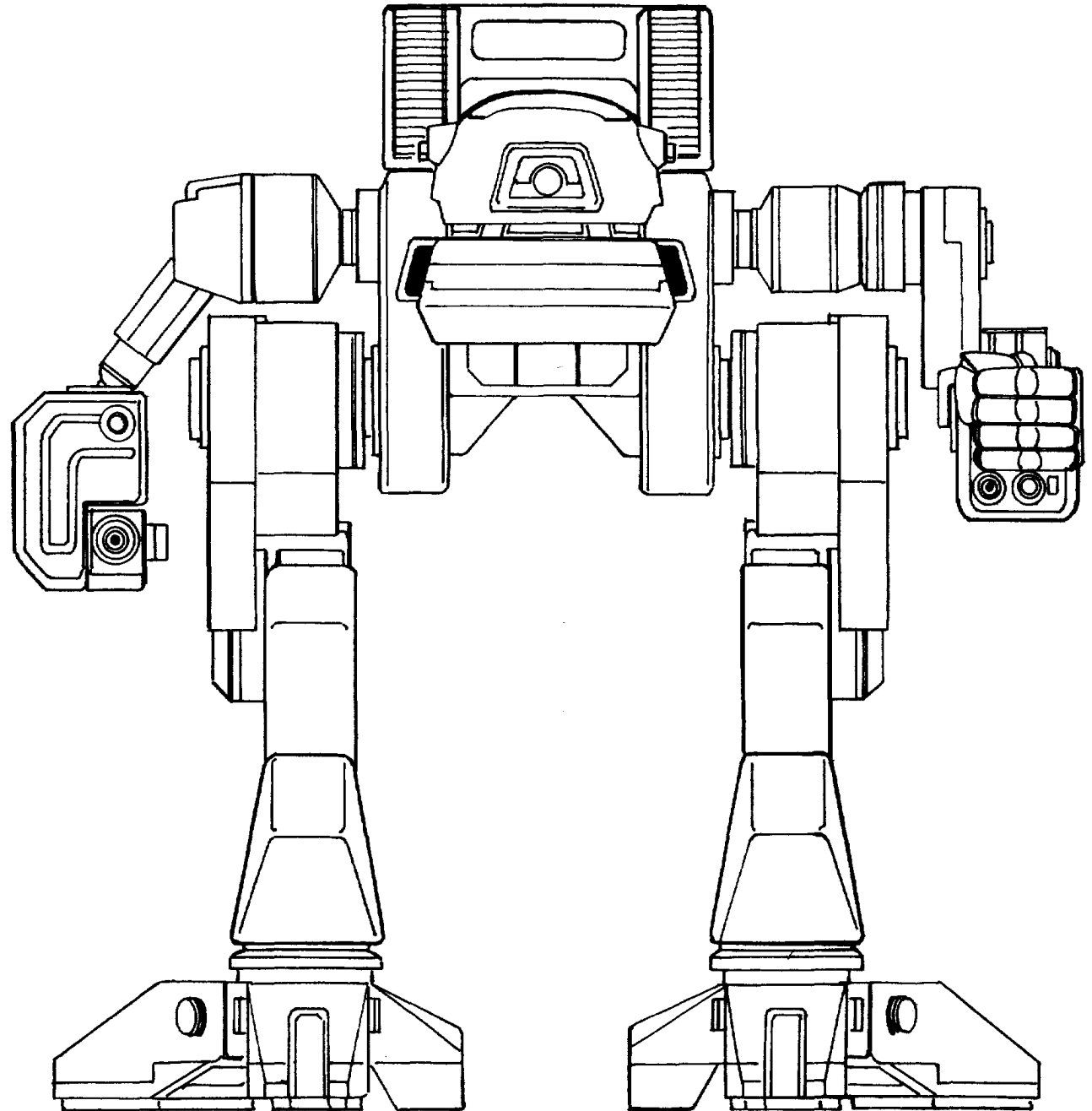

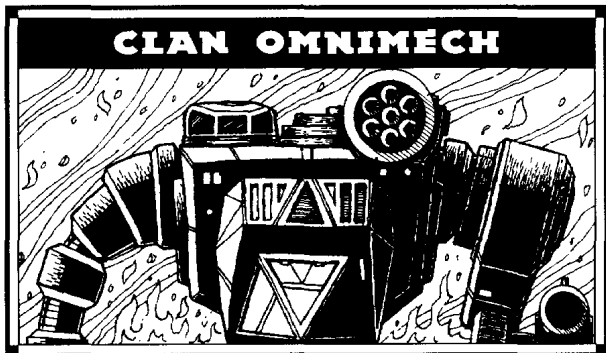

OVERVIEW

Inner Sphere MechWarriors nicknamed this 'Mech the *Puma* as a tribute to its ferocity. Though light and fast enough for scouting missions, the *Puma* can stand up to many Inner Sphere medium 'Mechs. It packs exceptional firepower for a light 'Mech, and many MechWarriors in the Successor States got a nasty surprise the first time they faced it in battle. The flamer in the *Puma's* center torso is one of the few fixed weapons on an Omnimech.

CAPABILITIES

When a *Puma* pilot expects heavy combat, he uses the 'Mech's most common configuration—double particle projection cannons, one in each arm. The PPCs deliver heavy damage, and the advanced targeting computer gives them devastating accuracy.

Alternate Configuration A turns the *Puma* into a fire-support 'Mech. The double LRM-20 racks on the arms can deliver enormous damage from afar, softening up the enemy for the *Puma's* Starmates. To deal with enemies that get too close, this design mounts a small pulse laser in each of the right and left torsos.

Alternate Configuration B features more varied weapons, and is used when the 'Mech may need to play several battlefield roles. Like the primary configuration, this version probably gives its pilots problems with heat buildup. A careful pilot, however, can take maximum advantage of this configuration's immense firepower and versatility. One arm mounts a large pulse laser, the other an LB 5-X autocannon. Extended-range medium lasers in the right and left torsos round out the weapons array.

Configuration C appears most often when several *Pumas* are used together. In these cases, all are equipped with Narc missiles, and a single *Puma-C* carries the Narc beacon for them all. As a trade-off, this configuration must downgrade its missile launchers to LRM-15s. This version also carries a medium pulse laser in its left torso rather than the small lasers carried by Configuration B.

Alternate Configuration D appears to be a variation on the *Puma-B*, and it has so far appeared rarely. This configuration features the Ultra-5 autocannon and an extended-range large laser, and carries Streak missile launchers rather than lasers in its right and left torsos.

DEPLOYMENT

The *Puma* sees widespread use among all the Clans, though it rarely serves as a reconnaissance 'Mech. Clan Wolf makes greater use of the *Puma* than the other Clans do, often assigning it to scouting missions. As a fire-support 'Mech, it serves with Stars of all compositions.

Mass: 35 tons

Chassis: Endo Steel

Power Plant: 210 XL

Cruising Speed: 64.8 kph

Maximum Speed: 97.2 kph

Jump Jets: None

Jump Capacity: None

Armor: Ferro-Fibrous

Armament:

1 Flamer

16 tons of pod space available

Manufacturer: Unknown

Communications System: Unknown

Targeting and Tracking System: Unknown

Type: **Adder**

Inner Sphere Designation: **Puma**

Technology Base: Clan Omnimech

Tonnage: 35

Equipment		Mass
Internal Structure:	Endo	2
Engine:	210 XL	4.5
Walking MP:	6	
Running MP:	9	
Jumping MP:	0	
Heat Sinks:	10 [20]	0
Gyro:		3
Cockpit:		3
Armor Factor:	115	6
	<i>Internal Structure</i>	<i>Armor Value</i>
Head	3	9
Center Torso	11	16
Center Torso (rear)		6
R/L Torso	8	12
R/L Torso (rear)		4
R/L Arm	6	12
R/L Leg	8	14

Weight and Space Allocation

Location	Fixed	Spaces Remaining
Head	1 Ferro-Fibrous	0
Center Torso	1 Flamer 1 Endo Steel	
Right Torso	2 XL Engine Double Heat Sink 1 Endo Steel 2 Ferro-Fibrous	5
Left Torso	2 XL Engine Double Heat Sink 1 Endo Steel 2 Ferro-Fibrous	5
Right Arm	1 Ferro-Fibrous	7
Left Arm	1 Ferro-Fibrous	7
Right Leg	2 Endo Steel	0
Left Leg	2 Endo Steel	0

Weapons and Ammo Location Critical Tonnage

Primary Weapons Configuration

Weapon	Location	Critical	Tonnage
ER PPC	LA	2	6
Double Heat Sink	LT	2	1
ER PPC	RA	2	6
Targeting Computer	RT	3	3

Weapons and Ammo Location Critical Tonnage

Alternate Configuration A

LRM 20	LA	4	5
Ammo (LRM) 12	LA	2	2
Small Pulse Laser	LT	1	1
LRM 20	RA	4	5
Ammo (LRM) 12	RA	2	2
Small Pulse Laser	RT	1	1

Alternate Configuration B

LB 5-X AC	LA	4	7
Ammo (LB-X) 20	LA	1	1
ER Medium Laser	LT	1	1
Large Pulse Laser	RA	2	6
ER Medium Laser	RT	1	1

Alternate Configuration C

LRM 15	LA	2	3.5
Ammo (LRM) 16	LA	2	2
Medium Pulse Laser	LT	1	2
LRM 15	RA	2	3.5
Ammo (LRM) 16	RA	2	2
Narc Missile Beacon	RT	1	2
Ammo (Narc) 6	RT	1	1

Alternate Configuration D

ER Large Laser	LA	1	4
Streak SRM 2	LT	1	1
Ammo (Streak) 50	LT	1	1
Ultra AC/5	RA	3	7
Ammo (Ultra) 20	RA	1	1
Streak SRM 2	RT	1	1
Ammo (Streak) 50	RT	1	1

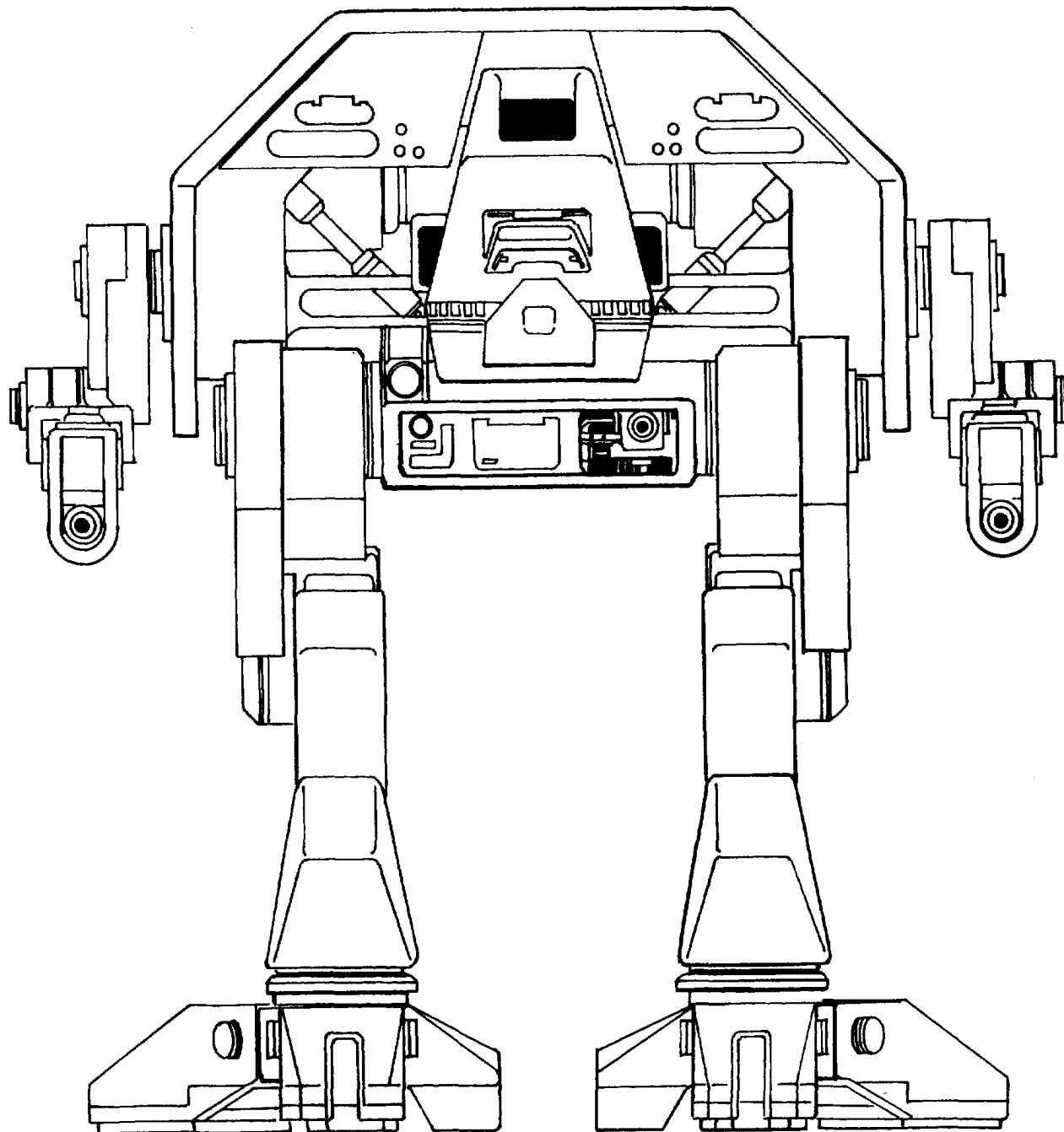

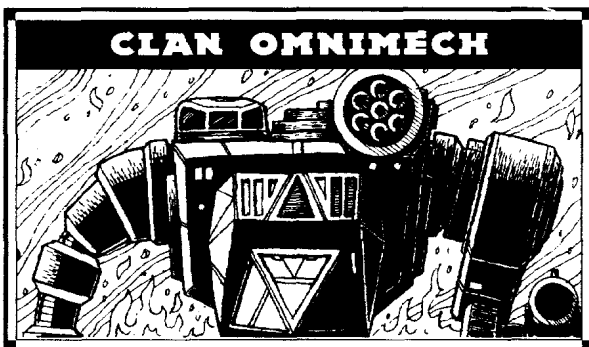

OVERVIEW

Earning its name from its erratic and swift movement, and also from its relative lack of firepower compared to other Clan 'Mechs, the *Dragonfly* is no less a nuisance to the Inner Sphere than its more powerful brethren. It has solid armor protection, double heat sinks, and excellent speed and jumping ability. With any of its weapons arrangements, the *Dragonfly* can cause trouble for an enemy and then leave the field to fight another day.

CAPABILITIES

In its standard configuration, the *Dragonfly* appears to try to accomplish too much with too little capacity. Mounting short-range missiles and medium pulse lasers as its main weapons, this version of the *Dragonfly* lacks the range advantage of most Clan 'Mechs. Though its speed and maneuverability can get the *Dragonfly* into close range quickly, its armor and armament are insufficient to fight pitched battles with other medium 'Mechs.

Alternate Configuration A makes the *Dragonfly* better equipped to slug it out at close range. The Artemis IV fire control system increases the effectiveness of the 'Mech's enlarged short-range missile rack. The suite of five medium lasers also enhances the *Dragonfly's* firepower, and the double heat sinks dissipate their heat quickly.

Alternate Configuration B is rare, and its surprise value helps compensate for its inherent weaknesses. Its clout is concentrated in the extended-range particle

projection cannon mounted on the left arm, with just enough pod space left over for two small pulse lasers. This weapons mix, like that of Alternate Configuration A, puts the *Dragonfly's* double heat sinks to the test.

Used exclusively in urban actions, Configuration C of the *Dragonfly* boasts a host of anti-personnel weapons. The paired machine guns in the left torso are linked to the double mount in the right torso, firing simultaneously or independently and sharing the same ammunition supplies. The three flamers can root out whatever hidden enemies the *Dragonfly's* Beagle active probe turns up. Two extended-range medium lasers in the left arm round out the weapons array.

Another general-purpose configuration apparently preferred by some Clan MechWarriors is the D variant. It offers excellent striking power and efficient ammunition use with a Streak SRM-6 in its left arm and a pair of medium lasers in its right arm. The small long-range missile launcher in the right torso allows the 'Mech to announce its presence, and the small laser in the left torso provides extra firepower at close range.

DEPLOYMENT

The *Dragonfly* is in common use only among the Ghost Bears. That Clan's preference for this comparatively weak design may be partly responsible for their relative lack of success compared to the other Clans. As a specialty 'Mech, however, the *Dragonfly* has its uses; the Ghost Bears' only mistake is overusing a 'Mech that is better suited for specialized roles and missions.

Mass: 40 tons

Chassis: Endo Steel

Power Plant: 320 XL

Cruising Speed: 86.4 kph

Maximum Speed: 129.6 kph

Jump Jets: 8

Jump Capacity: 240 meters

Armor: Ferro-Fibrous

Armament:

8.5 tons of pod space available

Manufacturer: Unknown

Communications System: Unknown

Targeting and Tracking System: Unknown

Type: **Viper**

Inner Sphere Designation: **Dragonfly**

Technology Base: Clan OmniMech

Tonnage: 40

Equipment		Mass
Internal Structure:	Endo	2
Engine:	320 XL	11.5
Walking MP:	8	
Running MP:	12	
Jumping MP:	8	
Heat Sinks:	10 [20]	0
Gyro:		4
Cockpit:		3
Armor Factor:	134	7
	<i>Internal Structure</i>	<i>Armor Value</i>
Head	3	9
Center Torso	12	16
Center Torso (rear)		7
R/L Torso	10	13
R/L Torso (rear)		7
R/L Arm	6	12
R/L Leg	10	19

Weight and Space Allocation

Location	Fixed	Spaces Remaining
Head	1 Ferro-Fibrous	0
Center Torso	1 Endo Steel	1
Right Torso	2 XL Engine	4
	2 Jump Jets	
	3 Endo Steel	
	1 Ferro-Fibrous	
Left Torso	2 XL Engine	4
	2 Jump Jets	
	3 Endo Steel	
	1 Ferro-Fibrous	
Right Arm	2 Ferro-Fibrous	6
Left Arm	2 Ferro-Fibrous	6
Right Leg	2 Jump Jets	0
Left Leg	2 Jump Jets	0

Weapons and Ammo Location Critical Tonnage

Primary Weapons Configuration

Weapon/Ammo	Location	Critical	Tonnage
SRM 4	LA	1	1
Ammo (SRM) 25	LA	1	1
Anti-Missile System	LT	1	.5
Ammo (Anti-Missile) 24	LT	1	1
Medium Pulse Laser	RA	1	2
Medium Pulse Laser	RA	1	2
Machine Gun	RT	1	.25
Machine Gun	RT	1	.25
Ammo (MG) 100	RT	1	.5

Weapons and Ammo Location Critical Tonnage
Alternate Configuration A

SRM 6	LA	1	1.5
Ammo (SRM) 15	LA	1	1
Artemis IV FCS	LA	1	1
ER Medium Laser	LT	1	1
ER Medium Laser	LT	1	1
ER Medium Laser	RA	1	1
ER Medium Laser	RT	1	1
ER Medium Laser	RT	1	1

Alternate Configuration B

ER PPC	LA	2	6
Small Pulse Laser	LT	1	1
Small Pulse Laser	RA	1	1
Flamer	RT	1	.5

Alternate Configuration C

Flamer	CT	1	.5
ER Medium Laser	LA	1	1
ER Medium Laser	LA	1	1
Active Probe	LA	1	1
Machine Gun	LT	1	.25
Machine Gun	LT	1	.25
Ammo (MG) 400	LT	2	2
Flamer	RA	1	.5
Flamer	RA	1	.5
Machine Gun	RT	1	.25
Machine Gun	RT	1	.25
Ammo (MG) 200	RT	1	1

Alternate Configuration D

Streak SRM 6	LA	2	3
Ammo (Streak) 15	LT	1	1
ER Small Laser	LT	1	.5
ER Medium Laser	RA	1	1
ER Medium Laser	RA	1	1
LRM 5	RT	1	1
Ammo (LRM) 24	RT	1	1

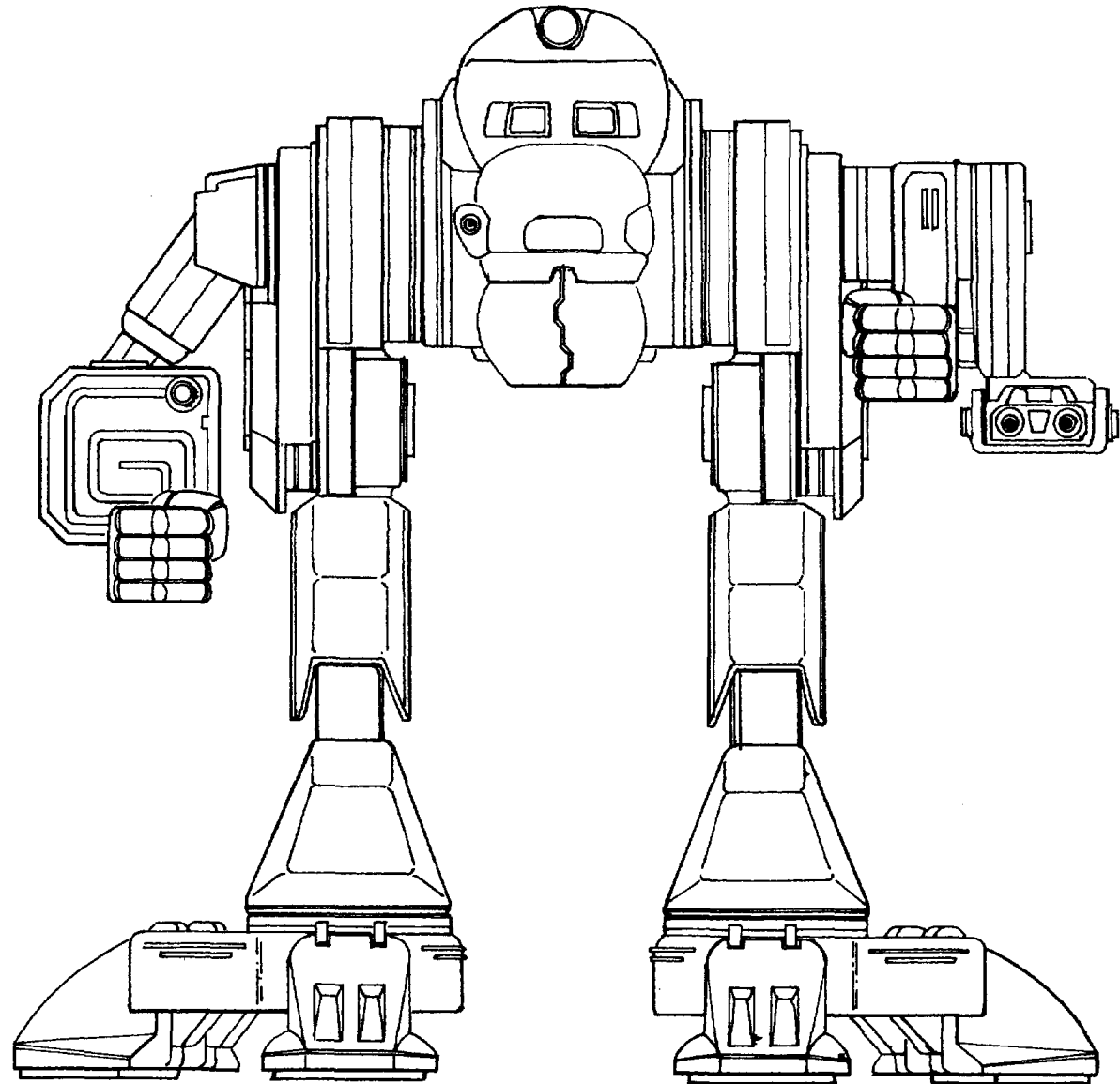



OVERVIEW

Not only is the Clans' equipment new to the Inner Sphere, but so are some of their tactics. The *Fenris* is an excellent example of a design alien to the strategists of the Successor States, a medium scout 'Mech. Though its weight class, armor, and standard weaponry clearly classify the *Fenris* as a medium 'Mech, other features make it useful for reconnaissance. It moves faster than many light 'Mechs, and it commonly carries the Beagle active probe, which allows it to locate hidden enemy positions. For these reasons, the *Fenris* has shown up on all sorts of missions and in many different roles.

CAPABILITIES

One of the few Clan designs to feature the Beagle active probe in its most common configuration, the *Fenris* sees regular reconnaissance duty regardless of the composition of the rest of its Star. Its extended-range particle projector cannon provides punch, augmented by a small Streak missile launcher and a small laser. The Streak system's efficient use of ammunition makes the *Fenris* an excellent candidate for long missions away from logistical support.

When accompanied by lighter 'Mechs assigned to providing reconnaissance, the *Fenris* often appears in Alternate Configuration A. Though lacking the long-range capabilities of the primary version, this model offers more weapons suited for infighting and carries an anti-missile system to reduce the effects of enemy fire. This configuration is most common when the *Fenris* is deployed in the same Star with heavier 'Mechs.

Configuration B appears only when the Clans expect a quick and costly battle at close range. In such a situation, the unmatched pair of short-range missile launchers carried by this variant can deliver heavy damage, following up that done by the extended-range large laser. In such a configuration, the *Fenris* can deliver enormous amounts of punishment at short range for a 'Mech of its size.

When called upon to provide long-range fire support, the *Fenris* appears in Alternate Configuration C. This design, rarely seen, is unusual in two respects. It has three LRM-5 launchers, allowing it to target three enemy 'Mechs at once. In addition, this version of the *Fenris* carries an Artemis IV fire-control system with each launcher, rather than a single Narc missile beacon for them all. The advantage of the independent systems is that some can continue operating after the *Fenris* has taken damage to one area.

Configuration D is used when the *Fenris* is on a long-range mission and lighter 'Mechs are providing reconnaissance. Though lacking the Beagle active probe, this version requires ammunition only for its anti-missile system. The combination of four medium pulse lasers on one frame is highly unusual.

DEPLOYMENT

Though the *Fenris* has played a large part in Clan Wolf's military successes, it is not widely used among the other Clan forces. Among the Wolves, the *Fenris* has a place in every Cluster and in almost every Star. The appearance of so many *Fenrises* in such widely differing configurations has caused great difficulties for MechWarriors in the Free Rasalhague Republic and, to a lesser extent, in the Federated Commonwealth.

Mass: 45 tons

Chassis: Endo Steel

Power Plant: 360 XL

Cruising Speed: 86.4 kph

Maximum Speed: 129.6 kph

Jump Jets: None

Jump Capacity: None

Armor: Ferro-Fibrous

Armament:

9.5 tons of pod space available

Manufacturer: Unknown

Communications System: Unknown

Targeting and Tracking System: Unknown

Type: **Ice Ferret**

Inner Sphere Designation: **Fenris**

Technology Base: Clan OmniMech

Tonnage: 45

Equipment		Mass
Internal Structure:	Endo	2.5
Engine:	360 XL	16.5
Walking MP:	8	
Running MP:	12	
Jumping MP:	0	
Heat Sinks:	12 [24]	2
Gyro:		4
Cockpit:		3
Armor Factor:	144	7.5
	Internal Structure	Armor Value
Head	3	9
Center Torso	14	19
Center Torso (rear)		8
R/L Torso	11	14
R/L Torso (rear)		7
R/L Arm	7	14
R/L Leg	11	19

Weight and Space Allocation

Location	Fixed	Spaces Remaining
Head	1 Ferro-Fibrous	0
Center Torso	1 Endo Steel	1
Right Torso	2 XL Engine	7
	1 Endo Steel	
Left Torso	2 Ferro-Fibrous	
	2 XL Engine	7
	1 Endo Steel	
	2 Ferro-Fibrous	
Right Arm	1 Ferro-Fibrous	7
Left Arm	1 Ferro-Fibrous	7
Right Leg	2 Endo Steel	0
Left Leg	2 Endo Steel	0

Weapons and Ammo Location Critical Tonnage

Primary Weapons Configuration

Weapon	Location	Critical	Tonnage
Active Probe	CT	1	1
ER PPC	LA	2	6
ER Small Laser	LA	1	.5
Streak SRM 2	RA	1	1
Ammo (Streak) 50	RA	1	1

Weapons and Ammo Location Critical Tonnage

Alternate Configuration A

ER Medium Laser	CT	1	1
LB 2-X AC	LA	3	5
Ammo (LB-X) 45	LA	1	1
ER Medium Laser	RA	1	1
Anti-Missile System	RA	1	.5
Ammo (Anti-Missile) 24	RA	1	1

Alternate Configuration B

Small Pulse Laser	CT	1	1
SRM 4	LA	1	1
Ammo (SRM) 25	LA	1	1
ER Large Laser	LA	1	4
SRM 6	RA	1	1.5
Ammo (SRM) 15	RA	1	1

Alternate Configuration C

ER Small Laser	CT	1	.5
LRM 5	LA	1	1
Ammo (LRM) 24	LA	1	1
Artemis IV FCS	LA	1	1
LRM 5	LT	1	1
Ammo (LRM) 24	LT	1	1
Artemis IV FCS	LT	1	1
LRM 5	RA	1	1
Ammo (LRM) 24	RA	1	1
Artemis IV FCS	RA	1	1

Alternate Configuration D

Medium Pulse Laser	CT	1	2
Anti-Missile System	LA	1	.5
Ammo (Anti-Missile) 24	LA	1	1
Medium Pulse Laser	LA	1	2
Medium Pulse Laser	RA	1	2
Medium Pulse Laser	RA	1	2

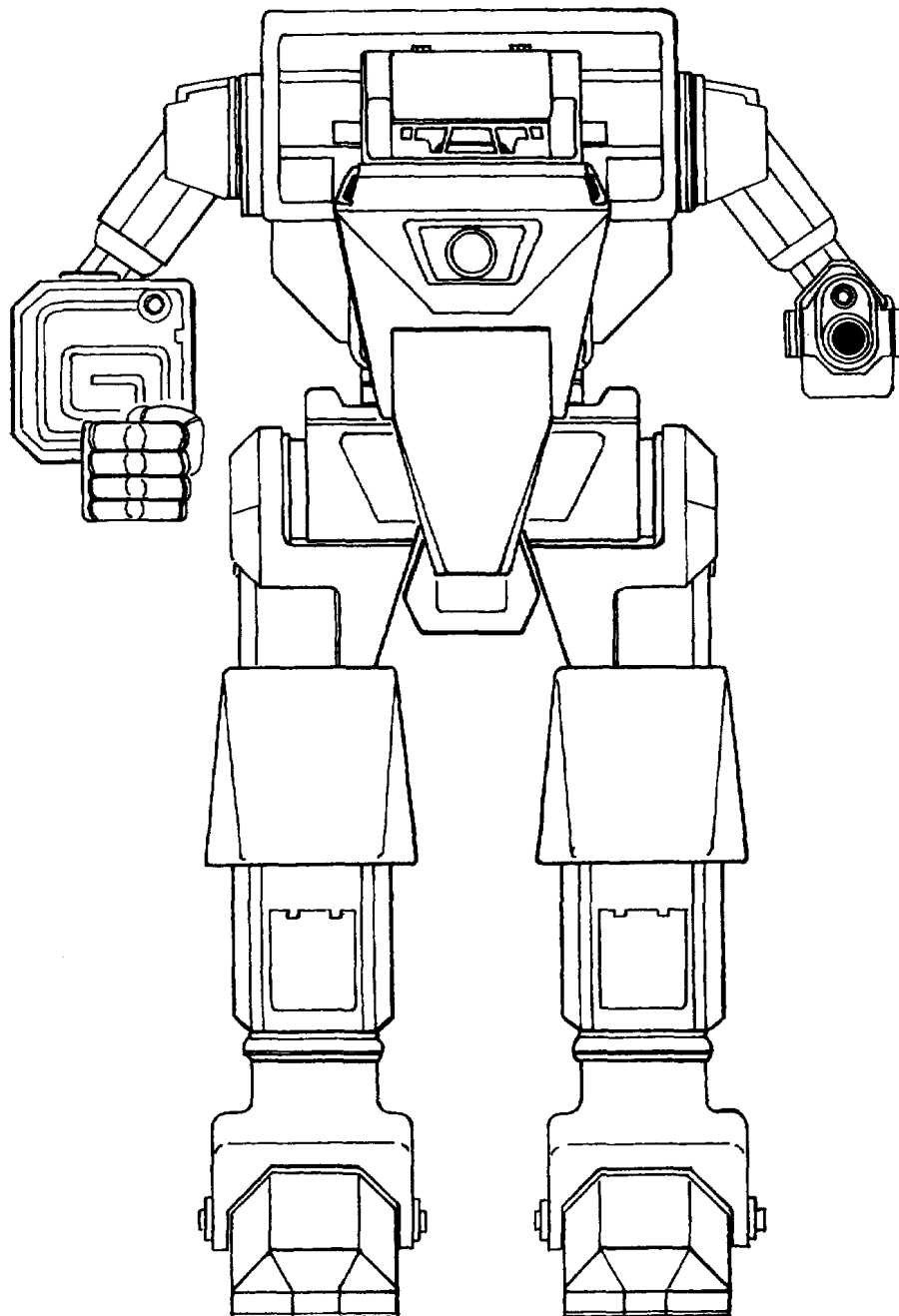

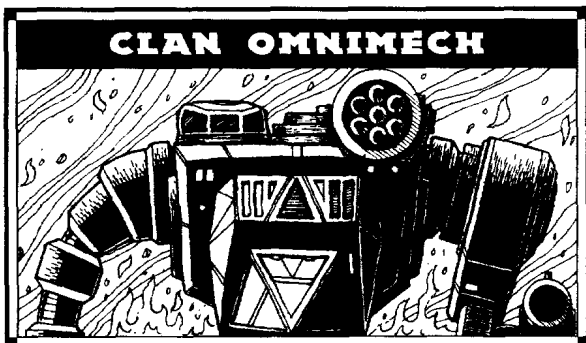

OVERVIEW

A 'Mech capable of many tasks but excelling at none, the *Black Hawk* plays a secondary role to heavier and lighter OmniMechs in the Clans' arsenal. Though versatile, powerful and maneuverable, it cannot match the power of heavier 'Mechs or the maneuverability of lighter ones. This 'Mech's versatility is its saving grace. Because it uses neither an endo steel internal structure nor ferro-fibrous armor, it possesses more internal space than some other designs. In addition, the *Black Hawk's* designers left its arms unencumbered, allowing for great flexibility in designing weapon pods.

CAPABILITIES

In its primary configuration, the *Black Hawk* has an unusual appearance and fearsome capabilities. The hexagonal weapon pods on its arms boast six medium lasers each, providing exceptional firepower but generating more heat than many 'Mechs can cope with. Only the *Black Hawk's* fourteen double heat sinks allow the pilot the freedom to use all of his laser weapons.

In its most common variation, Alternate Configuration A, the *Black Hawk* carries an extended-range particle projection cannon in each arm. This model usually carries a medium pulse laser in its left torso.

Alternate Configuration B reflects most MechWarriors' desire for a variety of weapons. This model combines the firepower of a large pulse laser with an Ultra-5 autocannon. It carries two machine guns in the left torso, plus 200 rounds of ammunition.

Occasionally, a powerful *Black Hawk* sporting a Gauss rifle makes an appearance. Installing such a heavy weapon must make such a 'Mech inherently unstable, taxing its gyros to the maximum. Carrying only an SRM-4 and small pulse laser for secondary armaments, this *Black Hawk* lacks the versatility that makes the design worthwhile. Hampered by too little ammunition for its primary weapon, this version is rarely used.

Alternate Configuration D is so far the only variation seen in the field that carries long-range missiles. Less effective than some designs at long-range fire support and yet not a well-rounded all-purpose design, this version of the *Black Hawk* appears to be deployed only when more suitable machines are unavailable.

DEPLOYMENT

The *Black Hawk* is deployed thinly but evenly throughout the Clans. It was first spotted with a Clan Wolf attack force, and it is slightly more common among the Wolf Clan than among others. Few Clan Clusters have more than one or two *Black Hawks* in their ranks.

Mass: 50 tons

Chassis: Standard

Power Plant: 250 XL

Cruising Speed: 54 kph

Maximum Speed: 86.4 kph

Jump Jets: 5

Jump Capacity: 150 meters

Armor: Standard

Armament:

16 tons of pod space available

Manufacturer: Unknown

Communications System: Unknown

Targeting and Tracking System: Unknown

Type: Nova

Inner Sphere Designation: Black Hawk

Technology Base: Clan OmniMech

Tonnage: 50

Equipment		Mass
Internal Structure:		5
Engine:	250 XL	6.5
Walking MP:	5	
Running MP:	8	
Jumping MP:	5	
Heat Sinks:	14 [28]	4
Gyro:		3
Cockpit:		3
Armor Factor:	160	10
	<i>Internal Structure</i>	<i>Armor Value</i>
Head	3	9
Center Torso	16	23
Center Torso (rear)		8
R/L Torso	12	16
R/L Torso (rear)		8
R/L Arm	8	16
R/L Leg	12	20

Weight and Space Allocation

Location	Fixed	Spaces Remaining
Head		1
Center Torso	1 Jump Jet	1
Right Torso	2 XL Engine	6
	2 Double Heat Sinks	
Left Torso	2 XL Engine	6
	2 Double Heat Sinks	
Right Arm		8
Left Arm		8
Right Leg	2 Jump Jets	0
Left Leg	2 Jump Jets	0

Weapons and Ammo Location Critical Tonnage

Primary Weapons Configuration

Weapon	Location	Critical	Tonnage
ER Medium Laser	LA	1	1
ER Medium Laser	LA	1	1
ER Medium Laser	LA	1	1
ER Medium Laser	LA	1	1
ER Medium Laser	LA	1	1
ER Medium Laser	LA	1	1
Double Heat Sink	LA	2	1
Double Heat Sink	LT	2	1
ER Medium Laser	RA	1	1
ER Medium Laser	RA	1	1
ER Medium Laser	RA	1	1
ER Medium Laser	RA	1	1

Weapons and Ammo Location Critical Tonnage

ER Medium Laser	RA	1	1
ER Medium Laser	RA	1	1
Double Heat Sink	RA	2	1
Double Heat Sink	RT	2	1

Alternate Configuration A

ER PPC	LA	2	6
Medium Pulse Laser	LT	1	2
Anti-Missile System	LT	1	.5
ER PPC	RA	2	6
Anti-Missile System	RT	1	.5
Ammo (Anti-Missile) 24	RT	1	1

Alternate Configuration B

Large Pulse Laser	LA	2	6
Ultra AC/5	RA	3	7
Ammo (Ultra) 20	RA	1	1
Machine Gun	LT	1	.25
Machine Gun	LT	1	.25
Ammo (MG) 200	LT	1	1

Alternate Configuration C

Gauss Rifle	LA	6	12
Ammo (Gauss) 8	LA	1	1
SRM 4	LT	1	1
Ammo (SRM) 25	LT	1	1
Small Pulse Laser	RT	1	1

Alternate Configuration D

LB 5-X AC	LA	4	7
Ammo (LB-X) 40	LA	2	2
LRM 20	RA	4	5
Ammo (LRM) 12	RA	2	2

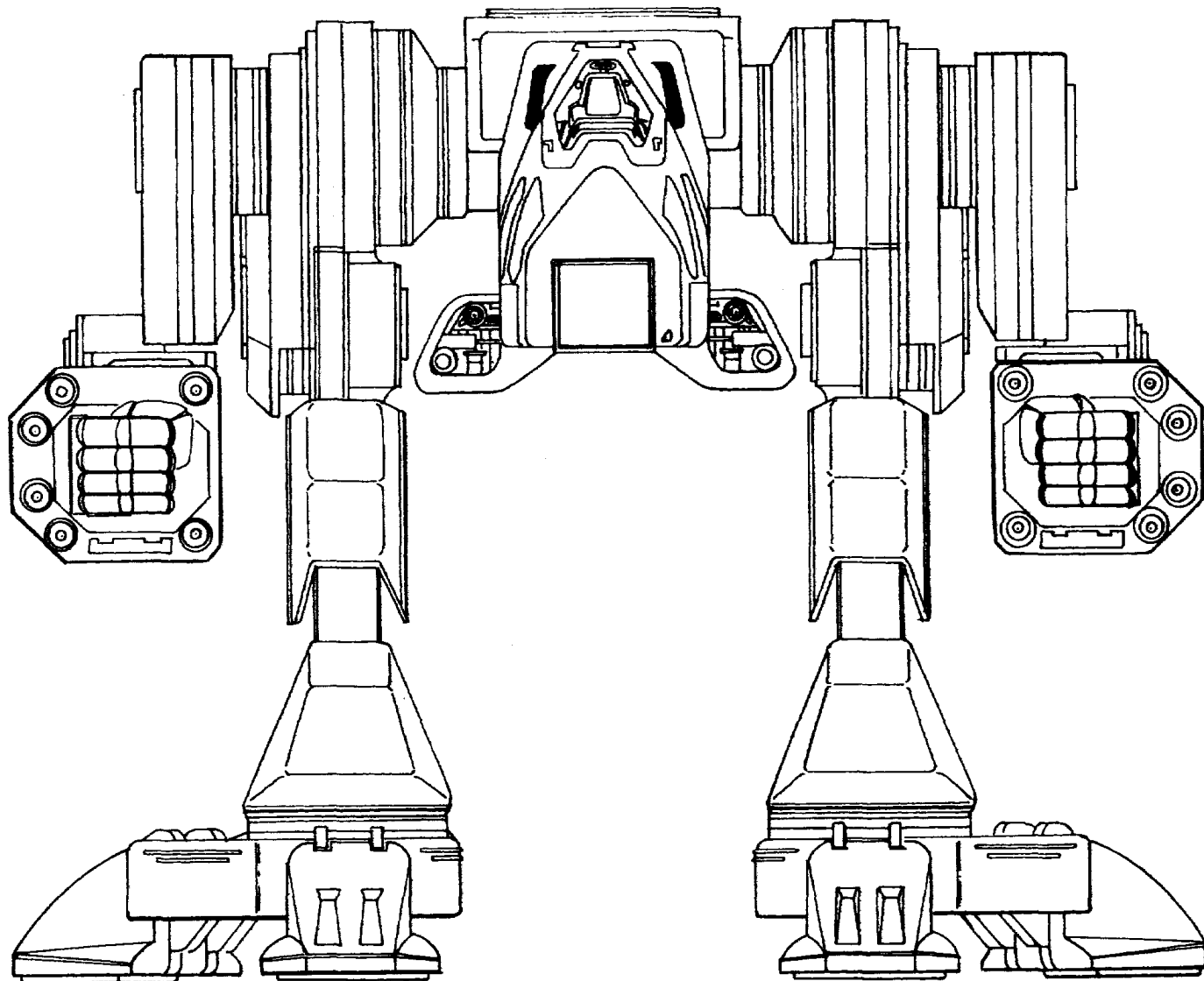

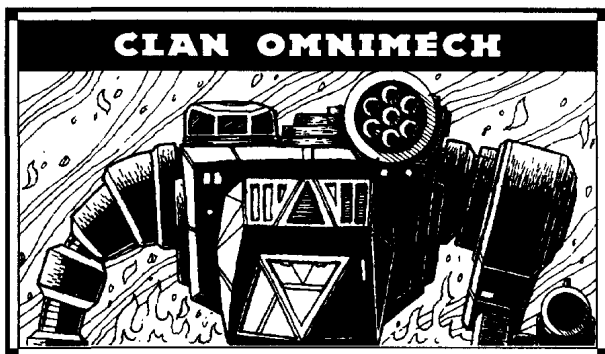

OVERVIEW

A menacing 'Mech whose characteristic configuration features arms that end in double-barreled large lasers, the *Ryoken* has earned respect and fear throughout the Successor States—especially in the Draconis Combine, where it first appeared. The *Ryoken* is versatile, efficient and deadly, with an extra-light engine, endo steel internal structure, ferro-fibrous armor, and double heat sinks. In all of its configurations, the *Ryoken* can deliver massive firepower for a medium 'Mech.

CAPABILITIES

The armies of the Inner Sphere were totally unprepared to face a 'Mech equipped with extended-range large and medium lasers on each arm and enough heat sinks to let the pilot use them. These lasers, plus an extended-range medium laser mounted in the 'Mech's head, can devastate a foe in moments. Because of its speed and firepower, this configuration of the *Ryoken* commands the respect of every armed force in the Successor States.

A common alternate, Configuration A, carries a giant LRM-20 rack on its right arm to soften up the enemy from a distance. It also sports four medium pulse lasers that can cause great damage quickly, plus ammunition-efficient Streak missiles mounted in its right and left torsos.

Alternate Configuration B features a massive Ultra-20 autocannon on its left arm. This version shares the *Black Hawk's* distinctive hexagonal arrangement of six extended-range medium lasers in its right arm.

Alternate Configuration C, thus far seen only among the Ghost Bears, features an LB 10-X autocannon on its left arm and a large pulse laser on the right. This C model also carries medium pulse lasers in its right and left torsos.

Alternate Configuration D is a mobile missile platform, with a Narc beacon that gives its impressive array of missile launchers greater accuracy. Not only does it carry a massive LRM-20 launcher and plenty of reloads on each arm, but its left torso also supports two SRM-2 racks. This triangular firing platform allows multiple targeting in an unusual mounting not seen in any Inner Sphere 'Mechs.

DEPLOYMENT

The *Ryoken*, in several configurations, is one of the most common 'Mechs in the Smoke Jaguar forces. The primary configuration is also common in the other Clans, but the alternates are less widespread. Especially among the Smoke Jaguars, the *Ryoken* draws so many different assignments that Draconis Combine MechWarriors can expect to battle these OmniMechs in almost any engagement.

Mass: 55 tons

Chassis: Endo Steel

Power Plant: 330 XL

Cruising Speed: 64.8 kph

Maximum Speed: 97.2 kph

Jump Jets: None

Jump Capacity: None

Armor: Ferro-Fibrous

Armament:

23 tons of pod space available

Manufacturer: Unknown

Communications System: Unknown

Targeting and Tracking System: Unknown

Type: **Stormcrow**

Inner Sphere Designation: **Ryoken**

Technology Base: Clan OmniMech

Tonnage: 55

Equipment		Mass
Internal Structure:	Endo	3
Engine:	330 XL	12.5
Walking MP:	6	
Running MP:	9	
Jumping MP:	0	
Heat Sinks:	10 [20]	0
Gyro:		4
Cockpit:		3
Armor Factor:	182	9.5
	<i>Internal Structure</i>	<i>Armor Value</i>
Head	3	9
Center Torso	18	25
Center Torso (rear)		10
R/L Torso	13	17
R/L Torso (rear)		9
R/L Arm	9	18
R/L Leg	13	25

Weight and Space Allocation

Location	Fixed	Spaces Remaining
Head		1
Center Torso	1 Endo Steel	0
	1 Ferro-Fibrous	
Right Torso	2 XL Engine	6
	1 Endo Steel	
	3 Ferro-Fibrous	
Left Torso	2 XL Engine	6
	1 Endo Steel	
	3 Ferro-Fibrous	
Right Arm		8
Left Arm		8
Right Leg	2 Endo Steel	0
Left Leg	2 Endo Steel	0

Weapons and Ammo Location Critical Tonnage

Primary Weapons Configuration

Weapon/Ammo	Location	Critical	Tonnage
ER Medium Laser	H	1	1
ER Large Laser	LA	1	4
ER Medium Laser	LA	1	1
3 Double Heat Sinks	LA	6	3
3 Double Heat Sinks	LT	6	3
ER Large Laser	RA	1	4
ER Medium Laser	RA	1	1
3 Double Heat Sinks	RA	6	3
3 Double Heat Sinks	RT	6	3

Weapons and Ammo Location Critical Tonnage
Alternate Configuration A

Medium Pulse Laser	LA	1	2
Medium Pulse Laser	LA	1	2
Medium Pulse Laser	LA	1	2
Medium Pulse Laser	LA	1	2
Streak SRM 6	LT	2	3
Ammo (Streak) 15	LT	1	1
LRM 20	RA	4	5
Ammo (LRM) 12	RA	2	2
Streak SRM 6	RT	2	3
Ammo (Streak) 15	RT	1	1

Alternate Configuration B

Ultra AC/20	LA	8	12
Ammo (Ultra) 10	LT	2	2
ER Medium Laser	RA	1	1
ER Medium Laser	RA	1	1
ER Medium Laser	RA	1	1
ER Medium Laser	RA	1	1
ER Medium Laser	RA	1	1
ER Medium Laser	RA	1	1
3 Double Heat Sinks	RT	6	3

Alternate Configuration C

LB 10-X AC	LA	5	10
Ammo (LB-X) 30	LA	3	3
Medium Pulse Laser	LT	1	2
Large Pulse Laser	RA	2	6
Medium Pulse Laser	RT	1	2

Alternate Configuration D

LRM 20	LA	4	5
Ammo (LRM) 18	LA	3	3
SRM 2	LT	1	.5
SRM 2	LT	1	.5
Ammo (SRM) 100	LT	2	2
LRM 20	RA	4	5
Ammo (LRM) 18	RA	3	3
Narc Missile Beacon	RT	1	2
Ammo (Narc) 12	RT	2	2

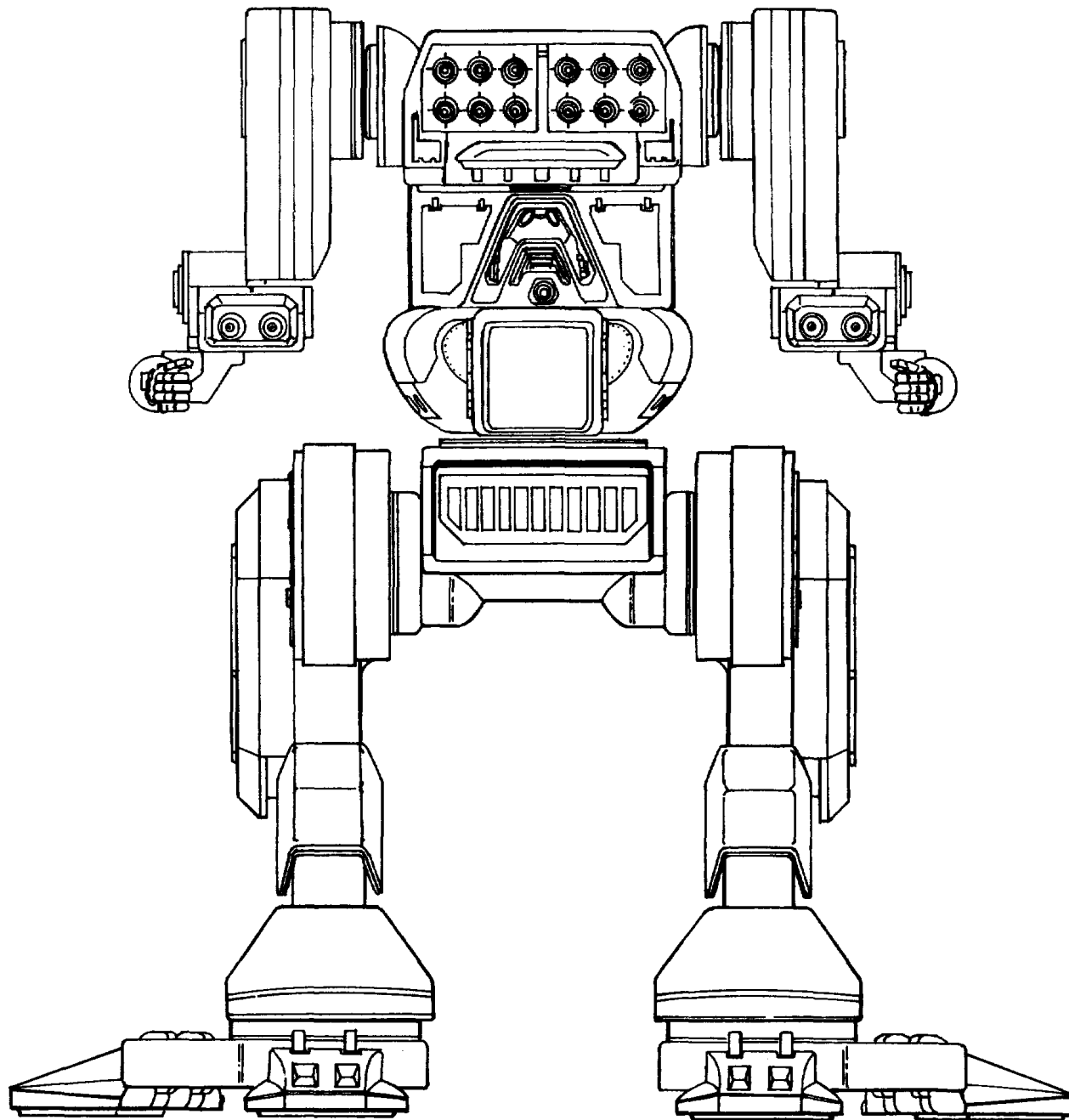

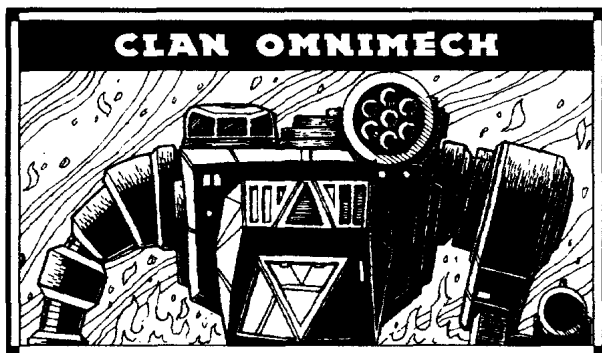

OVERVIEW

With its hunched shoulders and protruding head, this 'Mech resembles the vulture for which it is named. Tagged the *Vulture* by MechWarriors in the Free Rasalhague Republic and in the Draconis Combine, this 'Mech also has bird-like legs that enhance the comparison. The huge twin missile racks on its shoulders give the 'Mech its hunched look, but its overall appearance changes very little when other weapons pods are installed.

CAPABILITIES

In its primary configuration, the *Vulture* serves mostly as a fire-support 'Mech. Many Inner Sphere MechWarriors have commented on the sense of foreboding they felt at seeing a *Vulture* perched on a ridge, firing its missiles on the raging battle below as if waiting for its victims to die before swooping down for the carrion. The *Vulture's* twin LRM-20 racks can certainly hasten an enemy's death, and it frequently uses its laser weapons to administer the coup de grace to wounded foes.

Alternate Configuration A looks similar to the primary model, but is different in function. Three SRM-6 launchers replace the LRM racks on each shoulder, giving this version of the *Vulture* immense firepower at short range. The autocannon and PPC in the arms keep the enemy busy until this *Vulture* can bring its missiles to bear.

A hybrid between the first two configurations, Alternate Configuration B incorporates several refinements, including Streak technology for its two SRM-6 racks and an Artemis IV fire-control system for its single LRM-20. This variant also carries three medium pulse lasers in its right arm and two extended-range large lasers in its left arm.

So different in appearance from its counterparts that Inner Sphere MechWarriors originally thought it was a separate 'Mech, Alternate Configuration C of the *Vulture* does not even look like a vulture. In place of missile racks and lasers, the *Vulture D* carries two powerful Gauss rifles. So bulky are these weapons that this model must carry the ammunition for them in its puny arms. Weight restrictions prevent the model C from carrying any other weapons. Only by careful study of battle vids did strategists identify the leg and torso structure of this design as a *Vulture*.

DEPLOYMENT

First seen first in the Draconis Combine and the Free Rasalhague Republic, the *Vulture* has since appeared in the armed forces of all the Clans. Clan Ghost Bear uses it with the greatest frequency, but the Smoke Jaguars also favor this 'Mech. The *Vulture* is somewhat less common among the other Clan forces.

Mass: 60 tons

Chassis: Standard

Power Plant: 300 XL

Cruising Speed: 54 kph

Maximum Speed: 86.4 kph

Jump Jets: None

Jump Capacity: None

Armor: Ferro-Fibrous

Armament:

28 tons of pod space available

Manufacturer: Unknown

Communications System: Unknown

Targeting and Tracking System: Unknown

Type: Mad Dog

Inner Sphere Designation: *Vulture*

Technology Base: Clan Omnimech

Tonnage: 60

Equipment		Mass
Internal Structure:		6
Engine:	300 XL	9.5
Walking MP:	5	
Running MP:	8	
Jumping MP:	0	
Heat Sinks:	12 [24]	2
Gyro:		3
Cockpit:		3
Armor Factor:	163	8.5
	<i>Internal Structure</i>	<i>Armor Value</i>
Head	3	9
Center Torso	20	23
Center Torso (rear)		7
R/L Torso	14	16
R/L Torso (rear)		7
R/L Arm	10	16
R/L Leg	14	23

Weight and Space Allocation

Location	Fixed	Spaces Remaining
Head	1 Ferro-Fibrous	0
Center Torso		2
Right Torso	2 XL Engine 2 Ferro-Fibrous	8
Left Torso	2 XL Engine 2 Ferro-Fibrous	8
Right Arm	1 Ferro-Fibrous	7
Left Arm	1 Ferro-Fibrous	7
Right Leg		2
Left Leg		2

Weapons and Ammo	Location	Critical	Tonnage
<i>Primary Weapons Configuration</i>			
Large Pulse Laser	LA	2	6
Medium Pulse Laser	LA	1	2
LRM 20	LT	4	5
Ammo (LRM) 6	LT	1	1
Large Pulse Laser	RA	2	6
Medium Pulse Laser	RA	1	2
LRM 20	RT	4	5
Ammo (LRM) 6	RT	1	1

Weapons and Ammo Location Critical Tonnage
Alternate Configuration A

LB 5-X AC	LA	4	7
Ammo (LB-X) 40	LA	2	2
SRM 6	LT	1	1.5
SRM 6	LT	1	1.5
SRM 6	LT	1	1.5
Ammo (SRM) 30	LT	2	2
ER PPC	RA	2	6
SRM 6	RT	1	1.5
SRM 6	RT	1	1.5
SRM 6	RT	1	1.5
Ammo (SRM) 30	RT	2	2

Alternate Configuration B

ER Large Laser	LA	1	4
ER Large Laser	LA	1	4
LRM 20	LT	4	5
Ammo (LRM) 6	LT	1	1
Artemis IV FCS	LT	1	1
Medium Pulse Laser	RA	1	2
Medium Pulse Laser	RA	1	2
Medium Pulse Laser	RA	1	2
Streak SRM 6	RT	2	3
Streak SRM 6	RT	2	3
Ammo (Streak) 15	RT	1	1

Alternate Configuration C

Gauss Rifle	LA	6	12
Ammo (Gauss) 16	LA	2	2
Gauss Rifle	RA	6	12
Ammo (Gauss) 16	RA	2	2

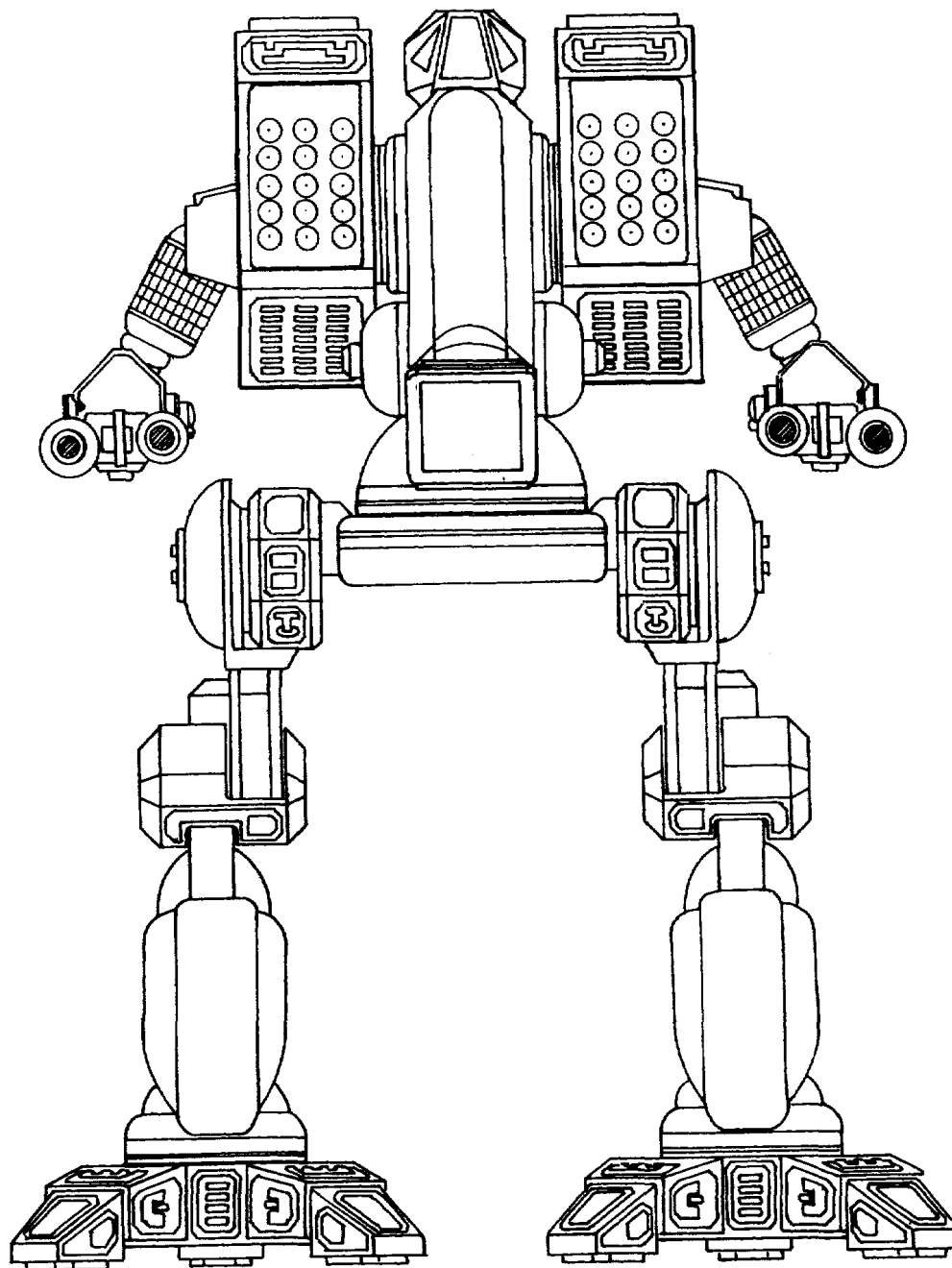

CLAN OMNIMECH

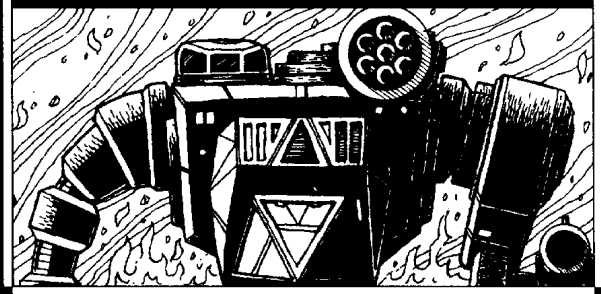

OVERVIEW

The *Loki* is one of the Clans' most easily recognized designs, with hexagonal openings in its huge *Marauder*-like arms. It also has an unusual standard configuration, with a missile rack on one shoulder and a beacon system on the other. Named the *Loki* by an obscure minor officer in the Armed Forces of the Federated Commonwealth, the 'Mech lives up to his description of its "utterly mad configuration," not only in the version he saw, but in all the others as well. Though the combinations of weapons may appear crazy, not a single Inner Sphere 'Mech could stand up to the *Loki* when it appeared among Clan attacking forces.

CAPABILITIES

The primary model of the *Loki* is an electronic marvel. It sports Guardian electronic countermeasures, a Beagle active probe, and a sophisticated targeting computer. Its blend of weapons systems is a sound combination of anti-'Mech and anti-personnel, long-range and short-range, and efficient ammunition use. However, the design cannot handle the massive amounts of heat generated by all these systems. Therefore, the MechWarrior must be cautious in his choice of targets so that the cockpit heat levels do not rise too high.

The most common alternative version of the *Loki* is used primarily for fire-support. Its long-range missile launcher and Narc missile beacon allow it to do significant damage before the enemy can even fire. At closer ranges, this version of the *Loki* can still deal out severe punishment with its autocannon and large lasers. One of the most unusual features of this design is the double pintle-mounted machine gun perched atop the missile launcher. This mount features a broad field of fire that keeps brash infantrymen well away from the *Loki*.

Featuring double Artemis fire-control systems for the side-by-side SRM-6 launchers on its shoulders, the *Loki B* can cripple an enemy with one volley at close range. With a Gauss rifle on one arm and an LB 5-X autocannon on the other, this 'Mech is one of the most formidable opponents the Clans have deployed.

DEPLOYMENT

The *Loki* is a favorite 'Mech of Clan Jade Falcon, though it appears in the other Clan forces in smaller numbers. It has been seen on all types of missions except for reconnaissance, and always proves to be the equal of two or more Inner Sphere 'Mechs.

Mass: 65 tons

Chassis: Standard

Power Plant: 325 XL

Cruising Speed: 54 kph

Maximum Speed: 86.4 kph

Jump Jets: None

Jump Capacity: None

Armor: Standard

Armament:

28.5 tons of pod space available

Manufacturer: Unknown

Communications System: Unknown

Targeting and Tracking System: Unknown

Type: **Hellbringer**

Inner Sphere Designation: **Loki**

Technology Base: Clan OmniMech

Tonnage: 65

Equipment		Mass
Internal Structure:		6.5
Engine:	325 XL	12
Walking MP:	5	
Running MP:	8	
Jumping MP:	0	
Heat Sinks:	13 [26]	3
Gyro:		4
Cockpit:		3
Armor Factor:	128	8
	<i>Internal Structure</i>	<i>Armor Value</i>
Head	3	9
Center Torso	21	17
Center Torso (rear)		8
R/L Torso	15	14
R/L Torso (rear)		7
R/L Arm	10	11
R/L Leg	15	15

Weight and Space Allocation

Location	Fixed	Spaces Remaining
Head		1
Center Torso		2
Right Torso	2 XL Engine	10
Left Torso	2 XL Engine	10
Right Arm		8
Left Arm		8
Right Leg		2
Left Leg		2

Weapons and Ammo Location Critical Tonnage

Primary Weapons Configuration

Weapon/Ammo	Location	Critical	Tonnage
Anti-Missile System	H	1	.5
Ammo (Anti-Missile) 24	CT	1	1
ER PPC	LA	2	6
A-Pod	LL	1	.5
A-Pod	LL	1	.5
ECM Suite	LT	1	1
Active Probe	LT	1	1
Targeting Computer	LT	3	3
ER Medium Laser	LT	1	1
ER Medium Laser	LT	1	1
ER Medium Laser	LT	1	1
ER PPC	RA	2	6
A-Pod	RL	1	.5
A-Pod	RL	1	.5

Weapons and Ammo	Location	Critical	Tonnage
Streak SRM 6	RT	2	3
Ammo (Streak) 15	RT	1	1
Machine Gun	RT	1	.25
Machine Gun	RT	1	.25
Ammo (MG) 100	RT	1	.5

Alternate Configuration A

ER Medium Laser	H	1	1
ER Large Laser	LA	1	4
ER Large Laser	LA	1	4
Active Probe	LT	1	1
Narc Missile Beacon	LT	1	2
Ammo (Narc) 6	LT	1	1
Ultra AC/5	RA	3	7
Ammo (Ultra) 20	RA	1	1
LRM 20	RT	4	5
Ammo (LRM) 6	RT	1	1
Machine Gun	RT	1	.25
Machine Gun	RT	1	.25
Ammo (MG) 200	CT	1	1

Alternate Configuration B

LB 5-X AC	LA	4	7
Ammo (LB-X) 20	LA	1	1
ER Small Laser	LT	1	.5
Gauss Rifle	RA	6	12
Ammo (Gauss) 8	RA	1	1
SRM 6	RT	1	1.5
Artemis IV FCS	RT	1	1
SRM 6	RT	1	1.5
Artemis IV FCS	RT	1	1
Ammo (SRM) 30	RT	2	2

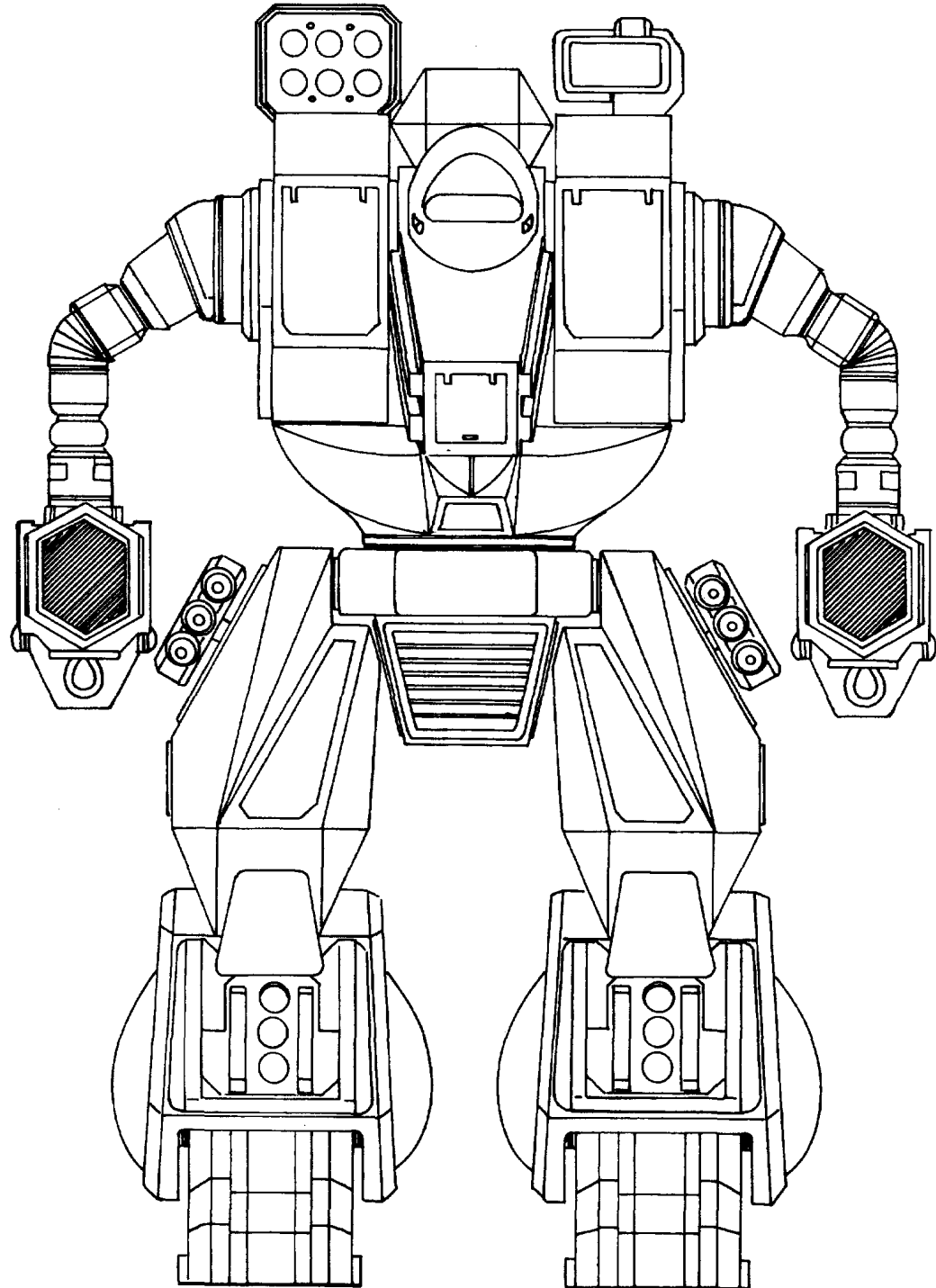

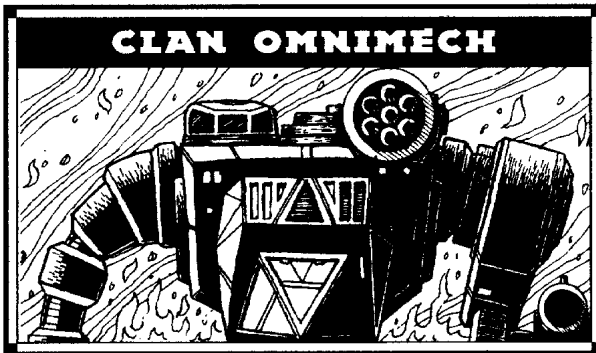

OVERVIEW

In all of its configurations, the *Thor's* main advantages over other heavier 'Mechs are its mobility and its ability to fire all its weapons with little worry about heat buildup. Apparently borrowing concepts from the *Warhammer*, *Marauder* and *Victor*, the *Thor* is an excellent all-around 'Mech. While the *Thor* may be less powerful than some and less quick than others, it successfully blends heavy firepower and maneuverability.

CAPABILITIES

The huge *Thor*, which stands at least a meter taller than most other 'Mechs, appears most often in a configuration remarkable for its lack of lasers. Its mix of weapons, however, combines with the 'Mech's maneuverability to make it a deadly foe. This model carries a long-range missile launcher in its left torso, a PPC on one arm, and a heavy autocannon on the other.

The most common variant, Alternate Configuration A, carries a powerful Gauss rifle on its left arm. With the SRM-6 in its left torso and the large pulse laser on its right arm, this model can cause immense damage with barely a blip from the heat gauge. The *Thor A* is renowned as an infighter.

Though it never ventures too far from logistical support, the *Thor B* is becoming more common among Clan forces. The combination of this configuration's Narc missile beacon with an unusually large array of missile launchers enables this model to do enormous

damage, as well as providing targeting information for its Starmates equipped with Narc missiles. Though it carries sufficient reloads for all of its launchers, the *Thor B* is poorly equipped to fight multiple engagements because it lacks other weapons when its missiles run out.

Alternate Configuration C carries a massive Ultra-20 autocannon, one of the most fearsome weapons known. Though it also carries extra shells for this weapon, the *Thor C* can suffer ammunition shortages in a prolonged engagement. Its other weapons include an SRM-6 in its left torso and a pair of extended-range lasers—one large, one small—on its right arm.

Alternate Configuration D is used for missions far from logistical support. Relying heavily on lasers, it also carries a sophisticated targeting computer to get the most out of its weapons. The extended-range lasers and the dual anti-missile system allow this *Thor* to keep its distance should it run into more than it can handle. Two machine guns mounted in each of the 'Mech's right and left torsos enable it to take on persistent opponents at close range if necessary.

DEPLOYMENT

The *Thor* is the heaviest design in general use among the Jade Falcons. It appears much more often among the Falcons than the other Clans, and the Falcons also use it differently. Other Clans use it as mobile support for assault 'Mechs, while the Jade Falcons use it as a quick-striking hammer to follow up a rapid advance.

Mass: 70 tons

Chassis: Standard

Power Plant: 350 XL

Cruising Speed: 54 kph

Maximum Speed: 86.4 kph

Jump Jets: 5

Jump Capacity: 150 meters

Armor: Ferro-Fibrous

Armament:

22.5 tons of pod space available

Manufacturer: Unknown

Communications System: Unknown

Targeting and Tracking System: Unknown

Type: Summoner

Inner Sphere Designation: Thor

Technology Base: Clan OmniMech

Tonnage: 70

Equipment		Mass
Internal Structure:		7
Engine:	350 XL	15
Walking MP:	5	
Running MP:	8	
Jumping MP:	5	
Heat Sinks:	14 [28]	4
Gyro:		4
Cockpit:		3
Armor Factor:	182	9.5
	<i>Internal Structure</i>	<i>Armor Value</i>
Head	3	9
Center Torso	22	27
Center Torso (rear)		8
R/L Torso	15	22
R/L Torso (rear)		7
R/L Arm	11	17
R/L Leg	15	23

Weight and Space Allocation

Location	Fixed	Spaces Remaining
Head	1 Ferro-Fibrous	0
Center Torso	1 Jump Jet	1
Right Torso	2 XL Engine	8
	2 Ferro-Fibrous	
Left Torso	2 XL Engine	8
	2 Ferro-Fibrous	
Right Arm	1 Ferro-Fibrous	7
Left Arm	1 Ferro-Fibrous	7
Right Leg	2 Jump Jets	0
Left Leg	2 Jump Jets	0

Weapons and Ammo Location Critical Tonnage

Primary Weapons Configuration

LB 10-X AC	LA	5	10
Ammo (LB-X) 10	LA	1	1
LRM 15	LT	2	3.5
Ammo (LRM) 16	LT	2	2
ER PPC	RA	2	6

Alternate Configuration A

Gauss Rifle	LA	6	12
Ammo (Gauss) 8	LA	1	1
SRM 6	LT	1	1.5
Ammo (SRM) 30	LT	2	2
Large Pulse Laser	RA	2	6

Weapons and Ammo Location Critical Tonnage

Alternate Configuration B

LRM 20	LA	4	5
Ammo (LRM) 12	LA	2	2
SRM 4	LA	1	1
Ammo (SRM) 25	LA	1	1
Anti-Missile System	LT	1	.5
Ammo (Anti-Missile) 24	LT	1	1
Narc Missile Beacon	LT	1	2
Ammo (Narc) 6	LT	1	1
LRM 20	RA	4	5
Ammo (LRM) 12	RA	2	2
SRM 4	RA	1	1
Ammo (SRM) 25	RA	1	1

Alternate Configuration C

Ultra AC/20	LA	8	12
Ammo (Ultra) 10	LT	2	2
Streak SRM 6	LT	2	3
Ammo (Streak) 15	LT	1	1
ER Large Laser	RA	1	4
ER Small Laser	RA	1	.5

Alternate Configuration D

ER Large Laser	LA	1	4
ER Medium Laser	LA	1	1
3 Double Heat Sinks	LA	6	3
Machine Gun	LT	1	.25
Ammo (MG) 200	LT	1	1
Anti-Missile System	LT	1	.5
Ammo (Anti-Missile) 48	LT	2	2
ER Large Laser	RA	1	4
ER Medium Laser	RA	1	1
3 Double Heat Sinks	RA	6	3
Anti-Missile System	RT	1	.5
Machine Gun	RT	1	.25
Targeting Computer	RT	2	2

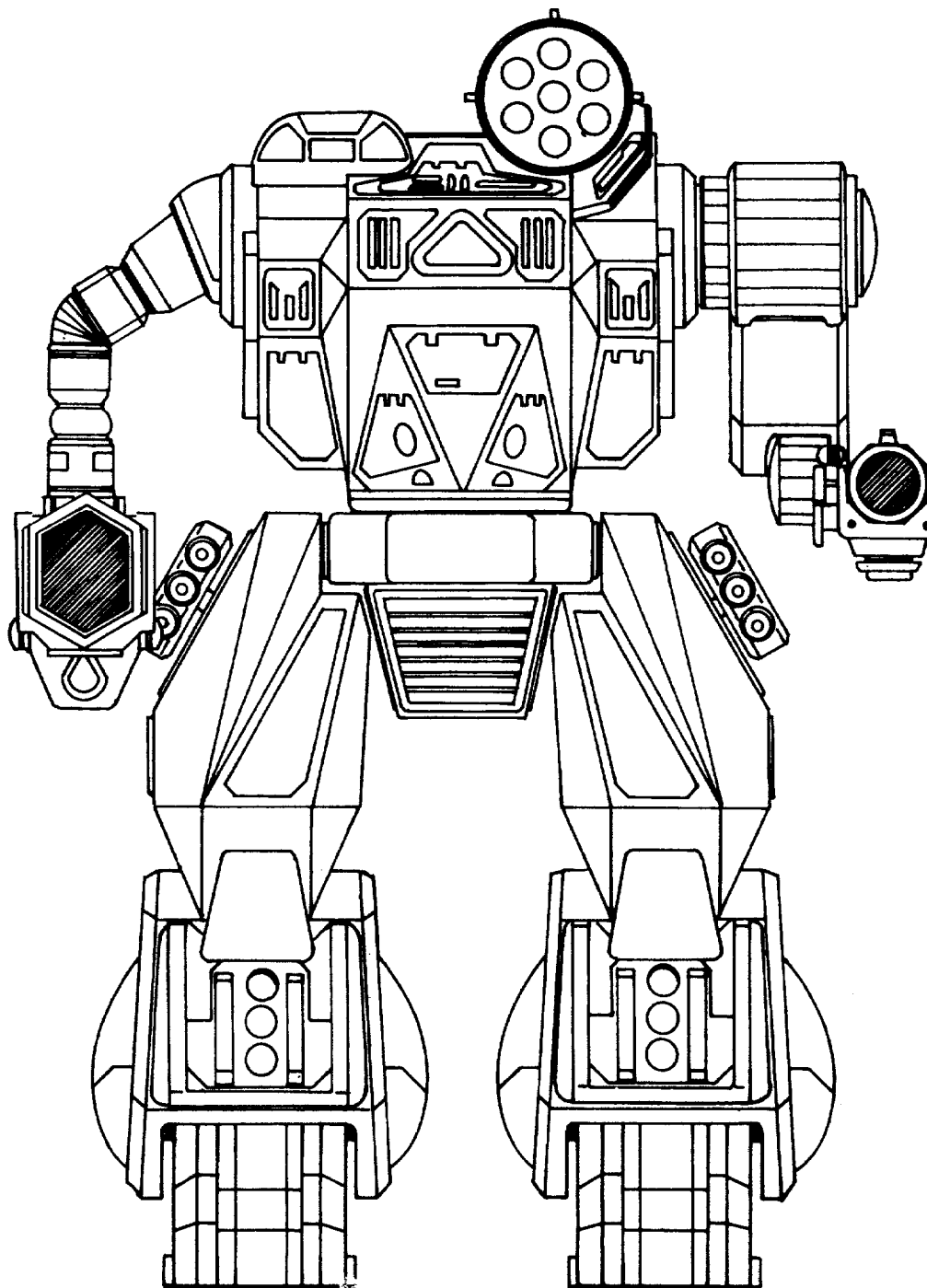

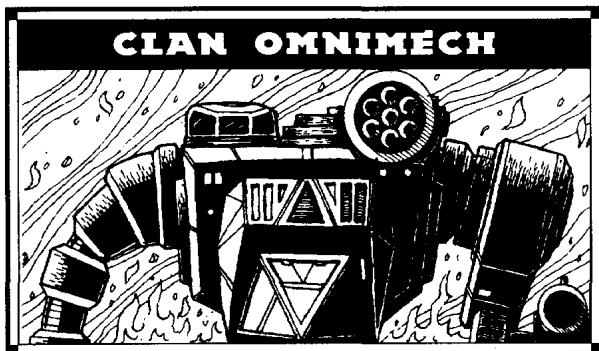

OVERVIEW

The *Mad Cat* was the first OmniMech the Inner Sphere encountered, on The Rock in the Oberon Confederation, on 13 August 3049. ComStar learned of these fantastic machines from a broadcast by a member of the Kell Hounds mercenary unit. ComStar named this design the *Mad Cat* because its hunched-over torso is common to both the *Marauder* and the *Catapult*. The *Mad Cat* is an exceptional combination of an XL engine, endo steel internal structure, ferro-fibrous armor, and double heat sinks. A double-barreled machine gun is mounted in the frame of the center torso.

CAPABILITIES

The most common configuration of the *Mad Cat* carries impressive firepower, starting with double LRM-20 racks on the shoulders. The weapons pods on the arms each contain an extended-range large laser and extended-range medium laser. The *Mad Cat* also incorporates pulse technology, with a medium pulse laser in its left torso. Two machine guns round out its weapons array.

Alternate Configuration A carries a short-range missile launcher on its right shoulder instead of the LRMs and a box-mount package of three medium pulse lasers in the left shoulder. It also features a particle projection cannon in each arm, with a small laser in the center torso.

Somewhat less common is a version that mounts a Gauss rifle in its right arm. Its left arm carries a large pulse laser and a small pulse laser. The version B *Mad Cat* makes use of the Artemis IV fire-control system for the LRM-10 rack on its left shoulder and the SRM-4 on its right shoulder.

The *Mad Cat C* also concentrates much of its firepower in its arm weapon pods. Its right arm carries an Ultra-5 autocannon, while the left has two extended-range large lasers. These leaves enough pod space for an LRM-15 launcher on each shoulder and an anti-missile system in the left torso.

Though rarely seen, Configuration D of the *Mad Cat* carries an especially unusual array of weapons. Apparently designed to fight in the enemy's midst, this version has double Streak SRM-6 launchers mounted on each shoulder, one pointing forward and the other to the rear. Each arm packs the devastating firepower of an extended-range particle projection cannon, and the center torso holds an extended-range small laser.

DEPLOYMENT

The *Mad Cat* is the favorite 'Mech of the Wolf Clan. It can claim a large share of the credit for the Wolves' great successes thus far, and no one can yet explain why it appears only in moderate numbers among the other Clans.

Mass: 75 tons

Chassis: Endo Steel

Power Plant: 375 XL

Cruising Speed: 54 kph

Maximum Speed: 86.4 kph

Jump Jets: None

Jump Capacity: None

Armor: Ferro-Fibrous

Armament:

27.5 tons of pod space available

Manufacturer: Unknown

Communications System: Unknown

Targeting and Tracking System: Unknown

Type: **Timber Wolf**

Inner Sphere Designation: **Mad Cat**

Technology Base: Clan OmniMech

Tonnage: 75

Equipment		Endo	Mass
Internal Structure:		4	4
Engine:	375 XL	19.5	
Walking MP:	5		
Running MP:	8		
Jumping MP:	0		
Heat Sinks:	15 [30]	5	
Gyro:		4	
Cockpit:		3	
Armor Factor:	230	12	
		<i>Internal Structure</i>	<i>Armor Value</i>
Head	3	9	
Center Torso	23	36	
Center Torso (rear)		9	
R/L Torso	16	25	
R/L Torso (rear)		7	
R/L Arm	12	24	
R/L Leg	16	32	

Weight and Space Allocation

Location	Fixed	Spaces Remaining
Head	1 Ferro-Fibrous	0
Center Torso	1 Endo Steel	1
Right Torso	2 XL Engine	7
	1 Endo Steel	
	2 Ferro-Fibrous	
Left Torso	2 XL Engine	7
	1 Endo Steel	
	2 Ferro-Fibrous	
Right Arm	1 Ferro-Fibrous	7
Left Arm	1 Ferro-Fibrous	7
Right Leg	2 Endo Steel	0
Left Leg	2 Endo Steel	0

Weapons and Ammo Location Critical Tonnage

Primary Weapons Configuration

Weapon	Location	Critical	Tonnage
Machine Gun	CT	1	.25
ER Large Laser	LA	1	4
ER Medium Laser	LA	1	1
Double Heat Sink	LA	2	1
Medium Pulse Laser	LT	1	2
LRM 20	LT	4	5
Ammo (LRM) 6	LT	1	1
ER Large Laser	RA	1	4
ER Medium Laser	RA	1	1
Double Heat Sink	RA	2	1
Machine Gun	RT	1	.25

Weapons and Ammo	Location	Critical	Tonnage
Ammo (MG) 200	RT	1	1
LRM 20	RT	4	5
Ammo (LRM) 6	RT	1	1

Alternate Configuration A

ER PPC	LA	2	6
2 Double Heat Sinks	LA	4	2
Medium Pulse Laser	LT	1	2
Medium Pulse Laser	LT	1	2
Medium Pulse Laser	LT	1	2
ER PPC	RA	2	6
3 Double Heat Sinks	LA	6	3
Streak SRM 6	RT	2	3
Ammo (Streak) 15	RT	1	1
ER Small Laser	CT	1	.5

Alternate Configuration B

Large Pulse Laser	LA	2	6
Small Pulse Laser	LA	1	1
LRM 10	LT	1	2.5
Ammo (LRM) 12	LT	1	1
Artemis IV FCS	LT	1	1
Gauss Rifle	RA	6	12
Ammo (Gauss) 8	RA	1	1
SRM 4	RT	1	1
Ammo (SRM) 25	RT	1	1
Artemis IV FCS	RT	1	1

Alternate Configuration C

ER Medium Laser	CT	1	1
ER Large Laser	LA	1	4
ER Large Laser	LA	1	4
LRM 15	LT	2	3.5
Ammo (LRM) 8	LT	1	1
Anti-Missile System	LT	1	.5
Ammo (Anti-Missile) 24	RT	1	1
Ultra AC/5	RA	3	7
Ammo (Ultra) 20	RA	1	1
LRM 15	RT	2	3.5
Ammo (LRM) 8	RT	1	1

Alternate Configuration D

ER Small Laser	CT	1	.5
ER PPC	LA	2	6
Streak SRM 6	LT	2	3
Streak SRM 6	LT (R)	2	3
Ammo (Streak) 15	LT	1	1
ER PPC	RA	2	6
Streak SRM 6	RT	2	3
Streak SRM 6	RT (R)	2	3
Ammo (Streak) 30	RT	2	2

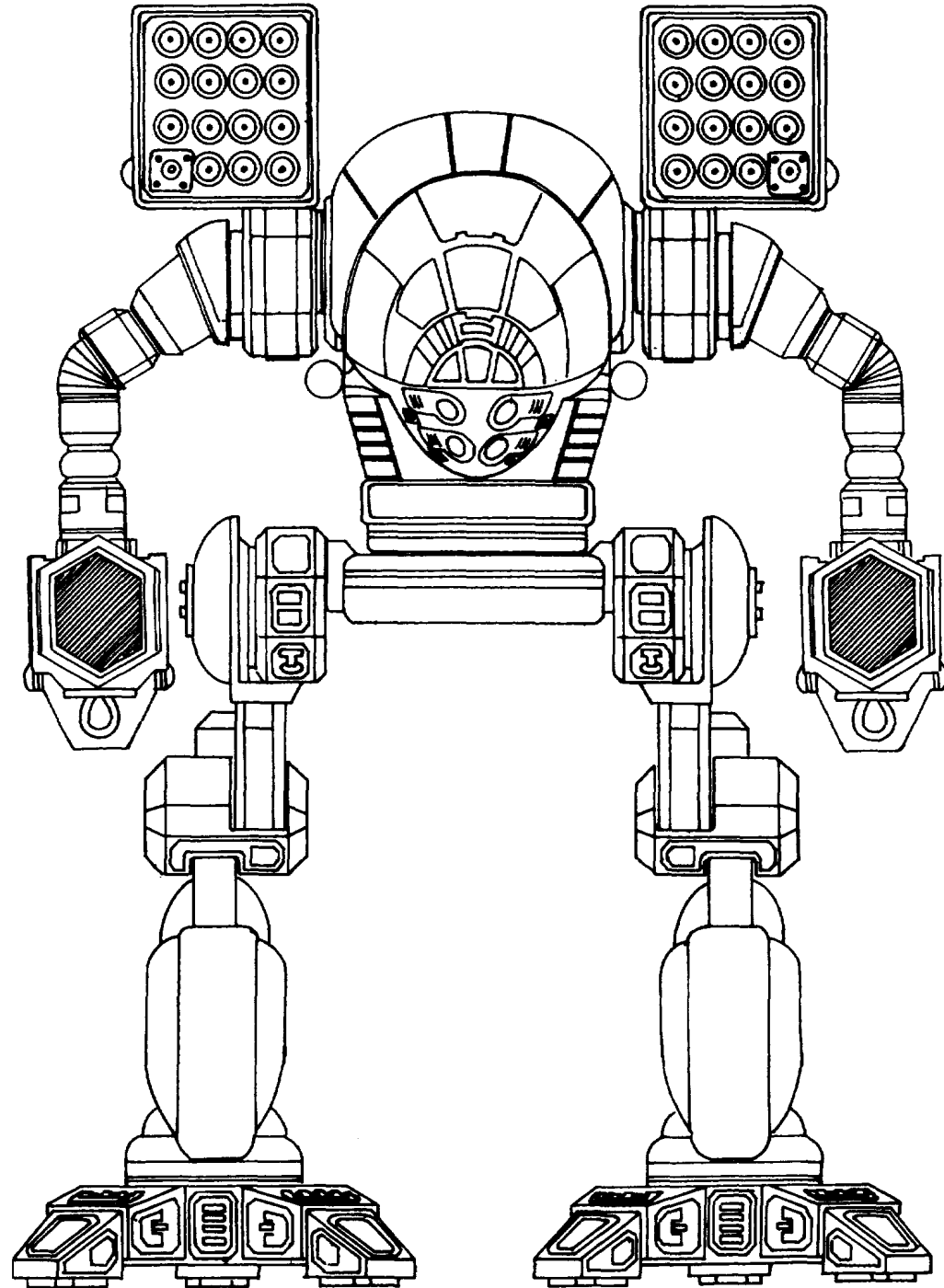

MAN O' WAR



OVERVIEW

With exceptional speed for an assault 'Mech and the ability to dissipate great amounts of heat in a short time, the *Man o' War* is a threat to enemy assault 'Mechs and smaller machines that can normally out-distance a 'Mech this size. In most configurations and on most missions, the *Man o' War* confronts enemy 'Mechs directly at medium and close range. A standard *Man o' War* resembles a *Warhammer* chassis with *Marauder* arms.

CAPABILITIES

Carrying almost all of its firepower in its arm-mounted weapon pods in all configurations, the *Man o' War* is a versatile design, requiring little time to change from one version to another. The most common combination of weapons is an LB 5-X autocannon and an SRM-6 missile launcher on each arm, with a small laser in the center torso. Almost as frequently seen is a model that carries two particle projection cannons in the right arm and four lasers in the left—a large pulse laser, a medium pulse laser, and extended-range medium and small lasers.

When extra firepower is needed, the *Man o' War* appears in Alternate Configuration B. This model lacks some of the versatility of the others but carries a powerful Gauss rifle. In the left arm, an SRM-4 rack sits atop an LRM-10 launcher, each supported by its own Artemis IV fire-control system.

Another favorite model is Alternate Configuration C, which carries a hexagonal array of medium lasers in its right arm. The left arm holds a massive Ultra-20 autocannon. For defense, this model has an A-pod on each leg.

DEPLOYMENT

Though more often seen among Clan Wolf forces than those of the other Clans, the *Man o' War* has played important roles across the entire invasion front. Its combination of speed and firepower makes it an excellent complement to various other Omnimechs.

- Mass:** 80 tons
- Chassis:** Standard
- Power Plant:** 400 XL
- Cruising Speed:** 53.8 kph
- Maximum Speed:** 86.2 kph
- Jump Jets:** None
- Jump Capacity:** None
- Armor:** Ferro-Fibrous
- Armament:**
21.5 tons of pod space available
- Manufacturer:** Unknown
- Communications System:** Unknown
- Targeting and Tracking System:** Unknown

Type: **Gargoyle**
 Inner Sphere Designation: **Man O' War**
 Technology Base: Clan OmniMech
 Tonnage: 80

Equipment		Mass
Internal Structure:		8
Engine:	400 XL	26.5
Walking MP:	5	
Running MP:	8	
Jumping MP:	0	
Heat Sinks:	16 [32]	6
Gyro:		4
Cockpit:		3
Armor Factor:	211	11
	<i>Internal Structure</i>	<i>Armor Value</i>
Head	3	9
Center Torso	25	30
Center Torso (rear)		10
R/L Torso	17	24
R/L Torso (rear)		10
R/L Arm	13	23
R/L Leg	17	24

Weight and Space Allocation

Location	Fixed	Spaces Remaining
Head	1 Ferro-Fibrous	0
Center Torso		2
Right Torso	2 XL Engine 2 Ferro-Fibrous	8
Left Torso	2 XL Engine 2 Ferro-Fibrous	8
Right Arm	1 Ferro-Fibrous	7
Left Arm	1 Ferro-Fibrous	7
Right Leg		2
Left Leg		2

Weapons and Ammo Location Critical Tonnage

<i>Primary Weapons Configuration</i>			
ER Small Laser	CT	1	.5
LB 5-X AC	LA	4	7
Ammo (LB-X) 20	LT	1	1
SRM 6	LA	1	1.5
Ammo (LRM) 15	LT	1	1
LB 5-X AC	RA	4	7
Ammo (LB-X) 20	RT	1	1
SRM 6	RA	1	1.5
Ammo (SRM) 15	RT	1	1

Weapons and Ammo Location Critical Tonnage

Alternate Configuration A

ER PPC	RA	2	6
ER PPC	RA	2	6
Large Pulse Laser	LA	2	6
Medium Pulse Laser	LA	1	2
ER Medium Laser	LA	1	1
ER Small Laser	LA	1	.5

Alternate Configuration B

LRM 10	LA	1	2.5
Ammo (LRM) 12	LA	1	1
Artemis IV FCS	LA	1	1
SRM 4	LA	1	1
Ammo (SRM) 25	LA	1	1
Artemis IV FCS	LA	1	1
Gauss Rifle	RA	6	12
Ammo (Gauss) 16	RA	2	2

Alternate Configuration C

Ultra AC/20	LA	8	12
Ammo (Ultra) 10	LT	2	2
A-Pod	LL	1	.5
ER Medium Laser	RA	1	1
ER Medium Laser	RA	1	1
ER Medium Laser	RA	1	1
ER Medium Laser	RA	1	1
ER Medium Laser	RA	1	1
ER Medium Laser	RA	1	1
A-Pod	RL	1	.5
A-Pod	RL	1	.5

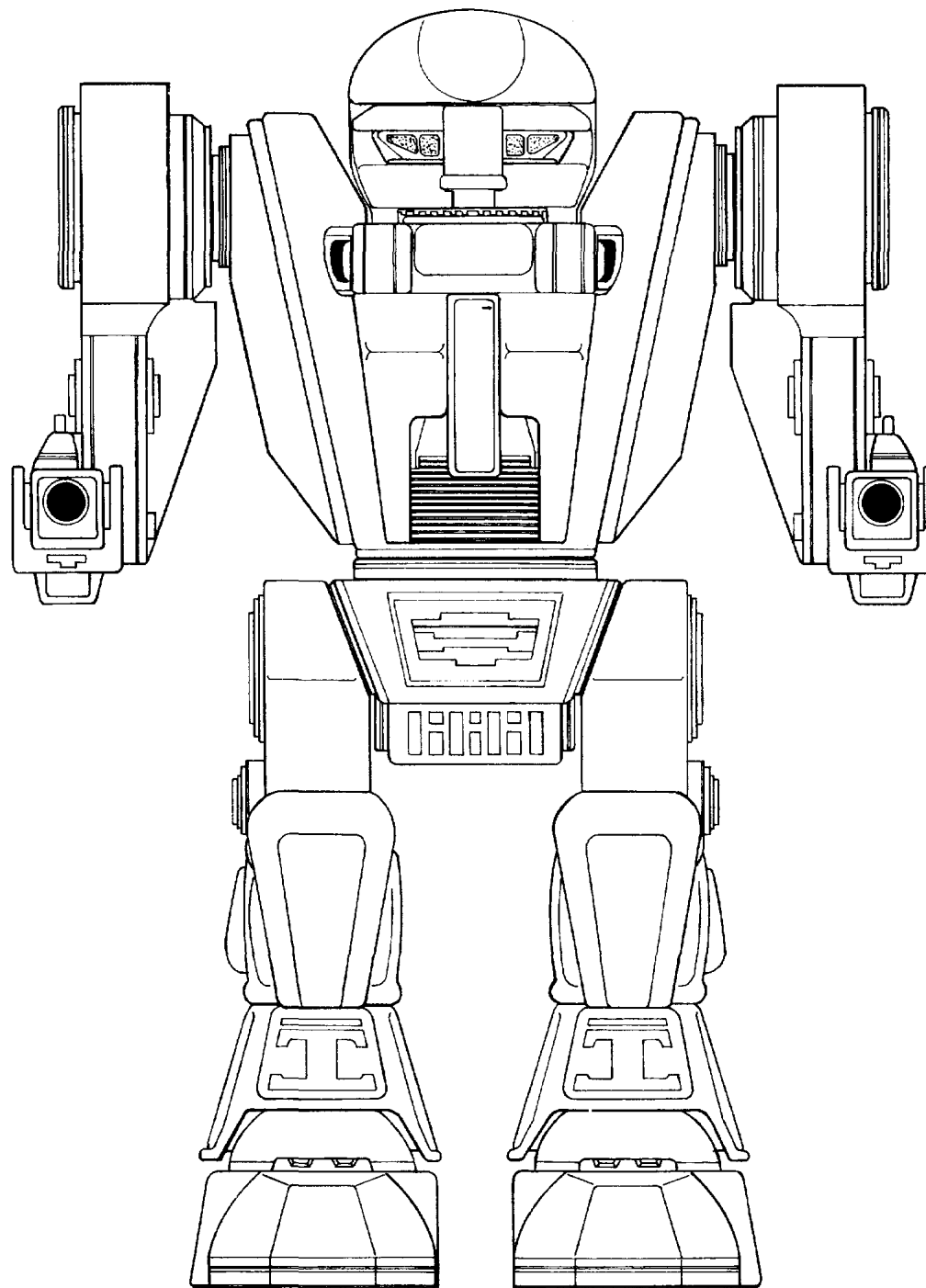

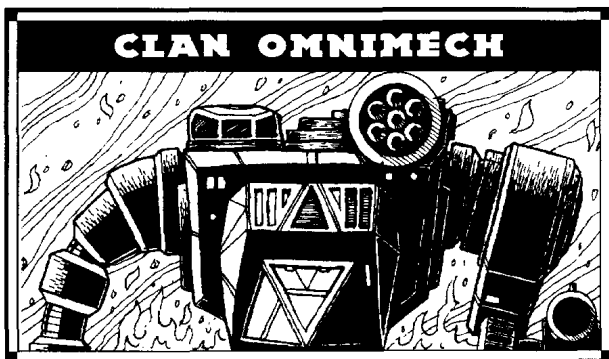

OVERVIEW

Easily identified by its squat torso, jutting head and broad chest, the *Masakari* has become notorious among Inner Sphere MechWarriors for its deadly accuracy. The 'Mech carries an advanced targeting computer, which apparently comes as standard equipment in all configurations. Though the computer must be modified for different weapons arrays, the basic computing boards appear to be built into the OmniMech's frame.

CAPABILITIES

The most familiar configuration of the *Masakari* carries two PPCs in each arm and a potent long-range missile launcher on its left shoulder. With the enhanced accuracy provided by the targeting computer, this model can destroy smaller 'Mechs with a single blast.

Alternate Configuration A carries a more diverse weapons array and can therefore perform more varied roles. The missile arrangement is a bit unusual, with a Streak SRM-6 launcher tucked into the left arm and an LRM-15 rack in the *Masakari's* right torso. It also carries an LB 10-X autocannon on its right arm and two extended-range large lasers on its left arm. This version has one other advantage over the primary model—it does not generate quite so much heat.

Alternate Configuration B is one of the most unusual designs so far spotted in the Clans' arsenal. This variant carries a mammoth Gauss rifle in its left arm, plus a triangular formation of extended-range medium lasers in its right arm. This design also features the Narc missile beacon and a pair of SRM-6 launchers perched side by side in the right torso.

Rarely seen, probably because of heat problems, is a *Masakari* configuration based entirely on laser weapons, PPCs and a flamer. This machine proves valuable on extended missions because it needs no ammunition reloads and has redundant weapons systems. The sheer amount of energy weapons, however, makes this 'Mech prone to heat build-up that even its double heat sinks cannot easily handle.

DEPLOYMENT

The *Masakari* appears most frequently with the Smoke Jaguars, who often pair it with the *Daishi*. It is also reasonably common among Clan Ghost Bear forces and has been seen on occasion with the Jade Falcons.

Mass: 85 tons
Chassis: Standard
Power Plant: 340 XL
Cruising Speed: 43.2 kph
Maximum Speed: 64.8 kph
Jump Jets: None
Jump Capacity: None
Armor: Ferro-Fibrous
Armament:
 32.5 tons of pod space available
Manufacturer: Unknown
Communications System: Unknown
Targeting and Tracking System: Unknown

Type: **Warhawk**
 Inner Sphere Designation: **Masakari**
 Technology Base: Clan OmniMech
 Tonnage: 85

Equipment		Mass
Internal Structure:		8.5
Engine:	340 XL	13.5
Walking MP:	4	
Running MP:	6	
Jumping MP:	0	
Heat Sinks:	20 [40]	10
Gyro:		4
Cockpit:		3
Armor Factor:	259	13.5
	<i>Internal Structure</i>	<i>Armor Value</i>
Head	3	9
Center Torso	27	42
Center Torso (rear)		10
R/L Torso	18	26
R/L Torso (rear)		10
R/L Arm	14	28
R/L Leg	18	35

Weight and Space Allocation

Location	Fixed	Spaces Remaining
Head	1 Ferro-Fibrous	0
Center Torso		2
Right Torso	2 XL Engine 2 Ferro-Fibrous	8
Left Torso	2 XL Engine 4 Double Heat Sinks 2 Ferro-Fibrous	0
Right Arm	1 Ferro-Fibrous	7
Left Arm	1 Ferro-Fibrous	7
Right Leg	Double Heat Sink	0
Left Leg	Double Heat Sink	0

Weapons and Ammo	Location	Critical	Tonnage
<i>Primary Weapons Configuration</i>			
ER PPC	LA	2	6
ER PPC	LA	2	6
LRM 10	LA	1	2.5
Ammo (LRM) 12	LA	1	1
ER PPC	RA	2	6
ER PPC	RA	2	6
Targeting Computer	RT	5	5

Weapons and Ammo Location Critical Tonnage
Alternate Configuration A

ER Large Laser	LA	1	4
ER Large Laser	LA	1	4
Streak SRM 6	LA	2	3
Ammo (Streak) 15	LA	1	1
LB 10-X AC	RA	5	10
Ammo (LB-X) 20	RA	2	2
LRM 15	RT	2	3.5
Ammo (LRM) 8	RA	1	1
Targeting Computer	RT	4	4

Alternate Configuration B

Narc Missile Beacon	CT	1	2
Ammo (Narc) 6	CT	1	1
Gauss Rifle	LA	6	12
Ammo (Gauss) 16	LA	2	2
ER Small Laser	LA	1	.5
ER Medium Laser	RA	1	1
ER Medium Laser	RA	1	1
ER Medium Laser	RA	1	1
Targeting Computer	RT	4	4
SRM 6	RT	1	1.5
SRM 6	RT	1	1.5
Ammo (SRM) 75	RA	5	5

Alternate Configuration C

Flamer	CT	1	.5
ER PPC	LA	2	6
ER PPC	LA	2	6
2 Double Heat Sinks	LA	4	2
Large Pulse Laser	RA	2	6
Large Pulse Laser	RA	2	6
Double Heat Sink	RA	2	1
Targeting Computer	RT	5	5

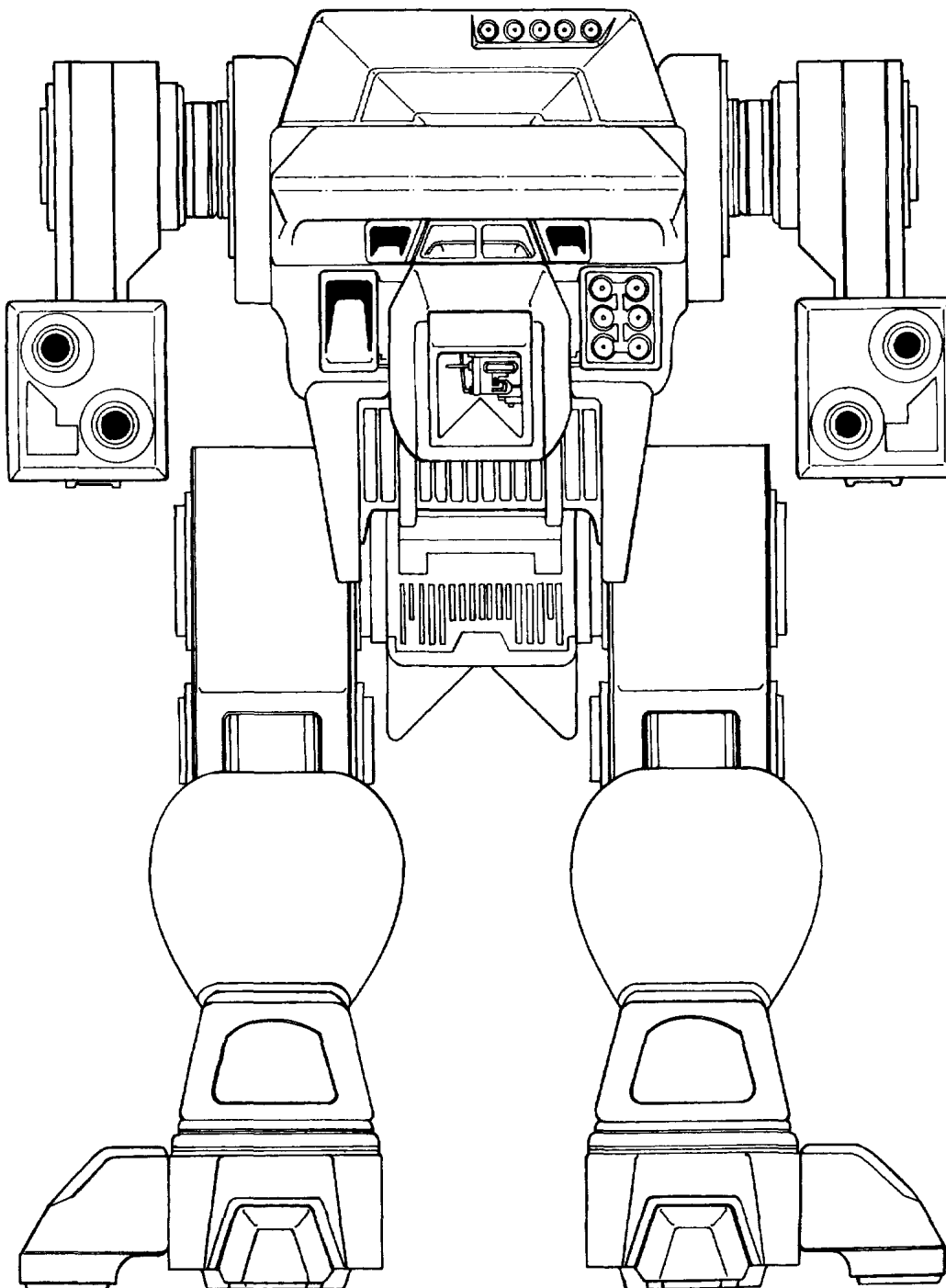

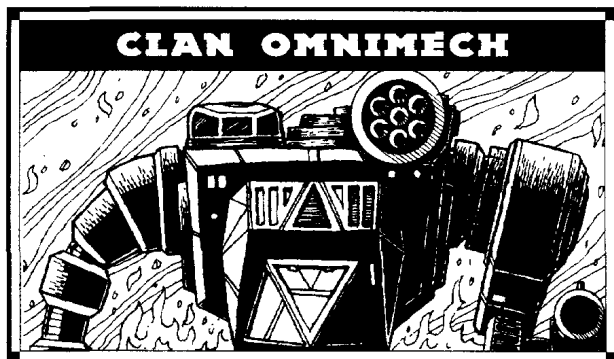

OVERVIEW

"What weighs ninety-five tons, can run at more than 80 kilometers per hour, can jump 120 meters, and carries a Gauss rifle?"

"I don't know, but I'm getting out of here."

This bit of low "MechWarrior humor" may never make it to the network holo-coms, but it accurately reflects the Inner Sphere's inability to deal with the *Gladiator*. Though some Inner Sphere 'Mechs are better armored and others carry more weapons, none can match the *Gladiator* with a skilled pilot in one-on-one combat. This OmniMech's exceptional maneuverability allows it to position itself better than other large 'Mechs, and its speed lets it swiftly pursue smaller 'Mechs. Such a 'Mech would be a treasure for the dueling warriors on Solaris.

CAPABILITIES

Most Clan MechWarriors who pilot a *Gladiator* choose the primary configuration because of the exceptional firepower of the Gauss rifle. This weapon combines with the pair of large lasers to deliver harsh punishment to opposing 'Mechs.

For extended missions where low ammunition supplies might cause problems, the Clans normally outfit the *Gladiator* with three large pulse lasers in the left arm and four extended-range medium lasers in the right. The *Gladiator* A's nineteen double heat sinks allow it to use this array of lasers and still keep its heat under control.

Somewhat similar in performance to the standard version is Configuration B, which carries the huge Ultra-20 autocannon in the left arm and an extended-range particle projection cannon in the right. An extended-range medium laser and anti-missile system round out this variant's weaponry.

Configuration C, the fire-support version of the *Gladiator*, is relatively uncommon. Its most distinguishing feature is the enhanced targeting incorporated into all its weapons systems. The LRM-20 rack has an Artemis IV fire-control system, and the Ultra-20 autocannon links directly to the sophisticated targeting computer.

A highly unusual design for the *Gladiator* has also been spotted on Pinnacle. Configuration D features two SRM-6 launchers affixed to its left arm. The right arm is a triangular pod with a large pulse laser at the top, a row of three medium pulse lasers below it, and a row of three small pulse lasers at the bottom. This configuration has no right hand, of course, and also requires the removal of the lower right arm actuator.

DEPLOYMENT

The *Gladiator* sees common service only with Clan Ghost Bear. The other Clans treat the design as a maverick, using it only for independent actions or in concert with other service branches, such as infantry.

Mass: 95 tons
Chassis: Standard
Power Plant: 380 XL
Cruising Speed: 42.8 kph
Maximum Speed: 65.2 kph, 86 kph w/ MASC
Jump Jets: 6
Jump Capacity: 120 meters

Armor: Ferro-Fibrous

Armament:

26.5 tons of pod space available

Manufacturer: Unknown

Communications System: Unknown

Targeting and Tracking System: Unknown

Type: **Executioner**

Inner Sphere Designation: **Gladiator**

Technology Base: Clan OmniMech

Tonnage: 95

Equipment		Mass
Internal Structure:		9.5
Engine:	380 XL	20.5
Walking MP:	4	
Running MP:	6 (8)	
Jumping MP:	4	
Heat Sinks:	16 [32]	6
Gyro:		4
Cockpit:		3
Armor Factor:	259	13.5
	<i>Internal Structure</i>	<i>Armor Value</i>
Head	3	9
Center Torso	30	37
Center Torso (rear)		9
R/L Torso	20	20
R/L Torso (rear)		10
R/L Arm	16	32
R/L Leg	20	40

Weight and Space Allocation

Location	Fixed	Spaces Remaining
Head	1 Ferro-Fibrous	0
Center Torso	2 Ferro-Fibrous	0
Right Torso	2 XL Engine Double Heat Sink 2 Ferro-Fibrous	6
Left Torso	2 XL Engine 4 MASC	6
Right Arm	1 Ferro-Fibrous	7
Left Arm	1 Ferro-Fibrous	7
Right Leg	2 Jump Jets	0
Left Leg	2 Jump Jets	0

Weapons and Ammo Location Critical Tonnage

Primary Weapons Configuration

Weapon	Location	Critical	Tonnage
Gauss Rifle	LA	6	12
Ammo (Gauss) 16	LT	2	2
Double Heat Sink	LA	2	1
ER Large Laser	RA	1	4
ER Large Laser	RA	1	4
2 Double Heat Sinks	RA	4	2
Machine Gun	RT	1	.25
Machine Gun	RT	1	.25
Ammo (MG) 200	RT	1	1

Weapons and Ammo Location Critical Tonnage
Alternate Configuration A

Large Pulse Laser	LA	2	6
Large Pulse Laser	LA	2	6
Large Pulse Laser	LA	2	6
Double Heat Sink	LA	2	1
ER Medium Laser	RA	1	1
ER Medium Laser	RA	1	1
ER Medium Laser	RA	1	1
ER Medium Laser	RA	1	1
2 Double Heat Sinks	RA	4	2
Machine Gun	RT	1	.25
Machine Gun	RT	1	.25
Ammo (MG) 200	RT	1	1

Alternate Configuration B

Ultra AC/20	LA	8	12
Ammo (Ultra) 15	LT	3	3
ER PPC	RA	2	6
3 Double Heat Sinks	RA	6	3
Anti-Missile System	RT	1	.5
Ammo (Anti-Missile) 24	RT	1	1
ER Medium Laser	RT	1	1

Alternate Configuration C

LRM 20	LA	4	5
Ammo (LRM) 12	LA	2	2
Artemis IV FCS	LA	1	1
ER Small Laser	LT	1	.5
Ultra AC/20	RA	8	12
Ammo (Ultra) 15	RT	3	3
Targeting Computer	RT	3	3

Alternate Configuration D

SRM 6	LA	1	1.5
SRM 6	LA	1	1.5
Ammo (SRM) 45	LA	3	3
ER Small Laser	LT	1	.5
Double Heat Sink	LT	2	1
Large Pulse Laser	RA	2	6
Medium Pulse Laser	RA	1	2
Medium Pulse Laser	RA	1	2
Medium Pulse Laser	RA	1	2
Small Pulse Laser	RA	1	1
Small Pulse Laser	RA	1	1
Small Pulse Laser	RA	1	1
Small Pulse Laser	RT	1	1
Small Pulse Laser	RT	1	1
2 Double Heat Sinks	RT	4	2

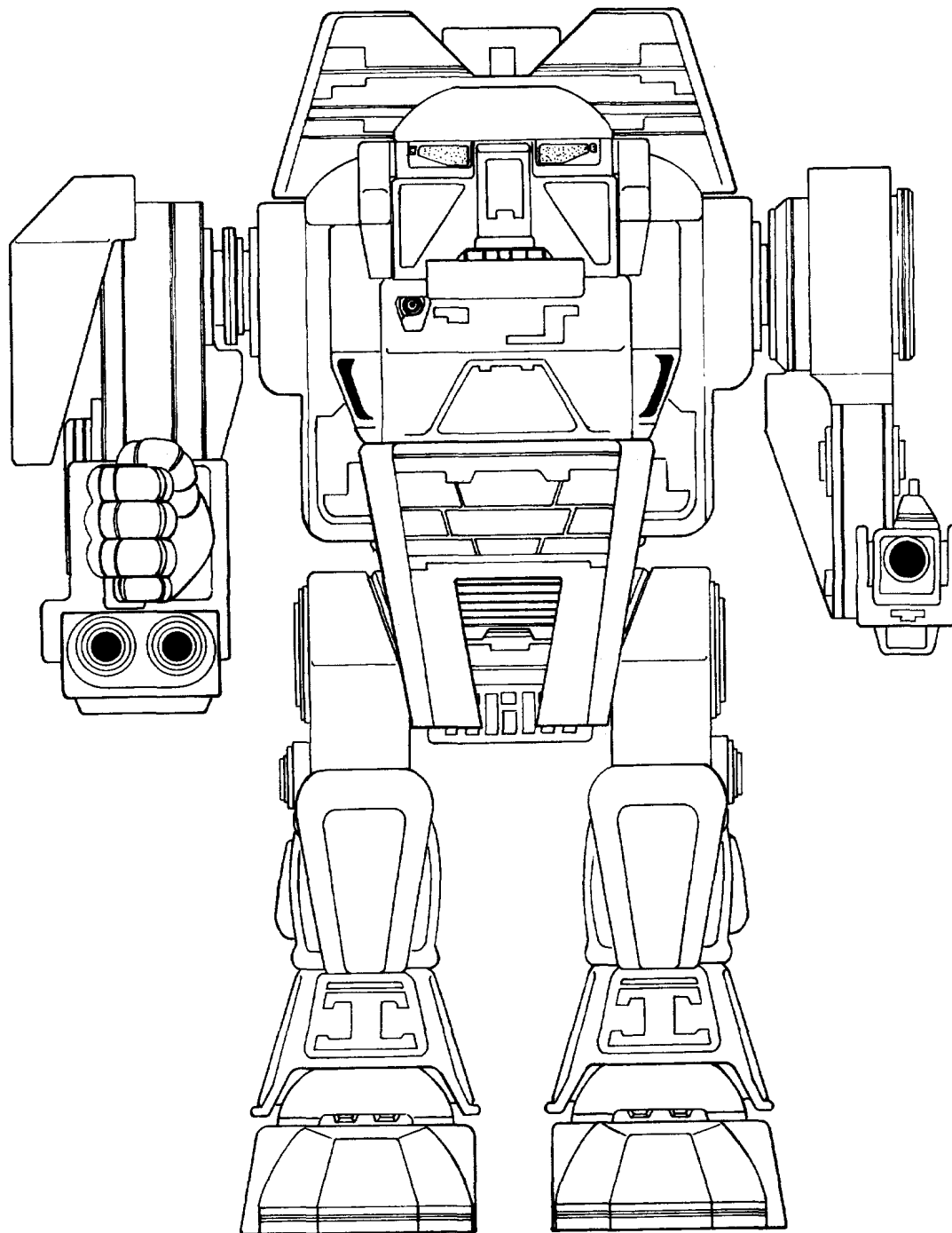

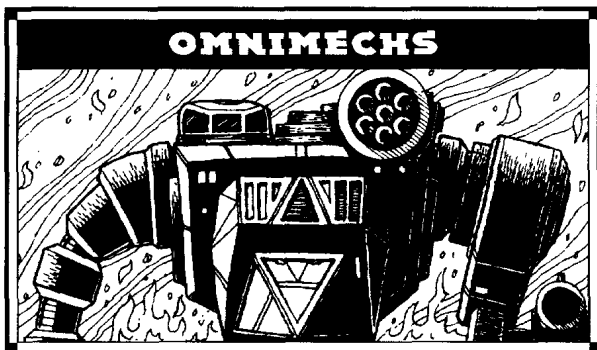

OVERVIEW

Supposedly christened *Daishi* (*Great Death*) by a member of the Draconis Combine's criminal underground, this 'Mech seems particularly aptly named. Though the left-shoulder mounted long-range missiles augment the 'Mech's firepower, it is the bundles of lasers, autocannons and other weapons in the arm pods that make the *Daishi* most fearsome. Slow but lethal, the *Daishi* is an assault 'Mech in the purest sense, able to wade through almost any defenses.

CAPABILITIES

The main configuration, by far the most common, features an LRM-10 rack in the left torso. In addition, each arm carries a bundle of death—an Ultra-5 autocannon, two extended-range large lasers, and two medium pulse lasers. Double heat sinks enable it to handle the heat generated by its multiple laser weapons.

The most common alternative configuration carries the huge Gauss rifle in its left arm, along with plenty of ammunition. The right arm holds three large pulse lasers. Dual Streak SRM-6 racks replace the long-range missile launcher in the left torso, and an anti-missile system protects the 'Mech against enemy attacks.

Configuration B has a turret-like assembly on both left and right shoulders instead of the lone missile launcher. This boxy apparatus contains four Ultra-2 autocannons, with a complicated ammunition feed to the shells stored in the torso below. The left arm has a pair of medium pulse lasers and a pair of extended-range particle projection cannons arranged in an X-pattern. Mounted on the right arm is an LB 10-X autocannon.

DEPLOYMENT

The *Daishi* is a favorite 'Mech among Clan Smoke Jaguar forces, who have used it to break through Kurita defenses time and again. According to dubious but persistent rumors, the Draconis Combine has managed to capture a *Daishi* intact. How Inner Sphere MechWarriors could seize such a war machine is a mystery, short of the defection of a Clan MechWarrior—an impossible act, from all that we know of these warlike people.

Mass: 100 tons
Chassis: Standard
Power Plant: 300 XL
Cruising Speed: 32.4 kph
Maximum Speed: 54 kph
Jump Jets: None
Jump Capacity: None
Armor: Standard
Armament:
 50.5 tons of pod space available
Manufacturer: Unknown
Communications System: Unknown
Targeting and Tracking System: Unknown

Type: **Dire Wolf**
 Inner Sphere Designation: **Daishi**
 Technology Base: Clan OmniMech
 Tonnage: 100

Equipment	Mass	
Internal Structure:		10
Engine:	300 XL	9.5
Walking MP:	3	
Running MP:	5	
Jumping MP:	0	
Heat Sinks:	15 [30]	5
Gyro:		3
Cockpit:		3
Armor Factor:	304	19
	<i>Internal Structure</i>	<i>Armor Value</i>
Head	3	9
Center Torso	31	47
Center Torso (rear)		14
R/L Torso	21	32
R/L Torso (rear)		10
R/L Arm	17	34
R/L Leg	21	41

Weight and Space Allocation

Location	Fixed	Spaces Remaining
Head		1
Center Torso		2
Right Torso	2 XL Engine Double Heat Sink	8
Left Torso	2 XL Engine Double Heat Sink	8
Right Arm		8
Left Arm		8
Right Leg		2
Left Leg	Double Heat Sink	0

Weapons and Ammo Location Critical Tonnage

<i>Primary Weapons Configuration</i>			
Double Heat Sink	CT	2	1
ER Large Laser	LA	1	4
ER Large Laser	LA	1	4
Medium Pulse Laser	LA	1	2
Medium Pulse Laser	LA	1	2
Ultra AC/5	LA	3	7
Ammo (Ultra) 20	LA	1	1
LRM 10	LT	1	2.5
Ammo (LRM) 12	LT	1	1
3 Double Heat Sinks	LT	6	3
ER Large Laser	RA	1	4
ER Large Laser	RA	1	4
Medium Pulse Laser	RA	1	2
Medium Pulse Laser	RA	1	2
Ultra AC/5	RA	3	7
Ammo (Ultra) 20	RA	1	1
3 Double Heat Sinks	RT	6	3

Alternate Configuration A

Double Heat Sink	CT	2	1
Gauss Rifle	LA	6	12
Ammo (Gauss) 24	LA	3	3
Streak SRM 6	LT	2	3
Streak SRM 6	LT	2	3
Ammo (Streak) 30	LT	2	2
Double Heat Sink	LT	2	1
Large Pulse Laser	RA	2	6
Large Pulse Laser	RA	2	6
Large Pulse Laser	RA	2	6
Double Heat Sink	RA	2	1
Anti-Missile System	RT	1	.5
Ammo (Anti-Missile) 72	RT	3	3
2 Double Heat Sinks	RT	4	2
Double Heat Sink	RL	2	1

Weapons and Ammo Location Critical Tonnage
Alternate Configuration B

ER Small Laser	CT	1	.5
ER PPC	LA	2	6
ER PPC	LA	2	6
Medium Pulse Laser	LA	1	2
Medium Pulse Laser	LA	1	2
Ultra AC/2	LT	2	5
Ultra AC/2	LT	2	5
Ammo (Ultra) 45	LT	1	1
LB 10-X AC	RA	5	10
Ammo (LB-X) 20	RA	2	2
Ultra AC/2	RT	2	5
Ultra AC/2	RT	2	5
Ammo (Ultra) 45	RT	1	1

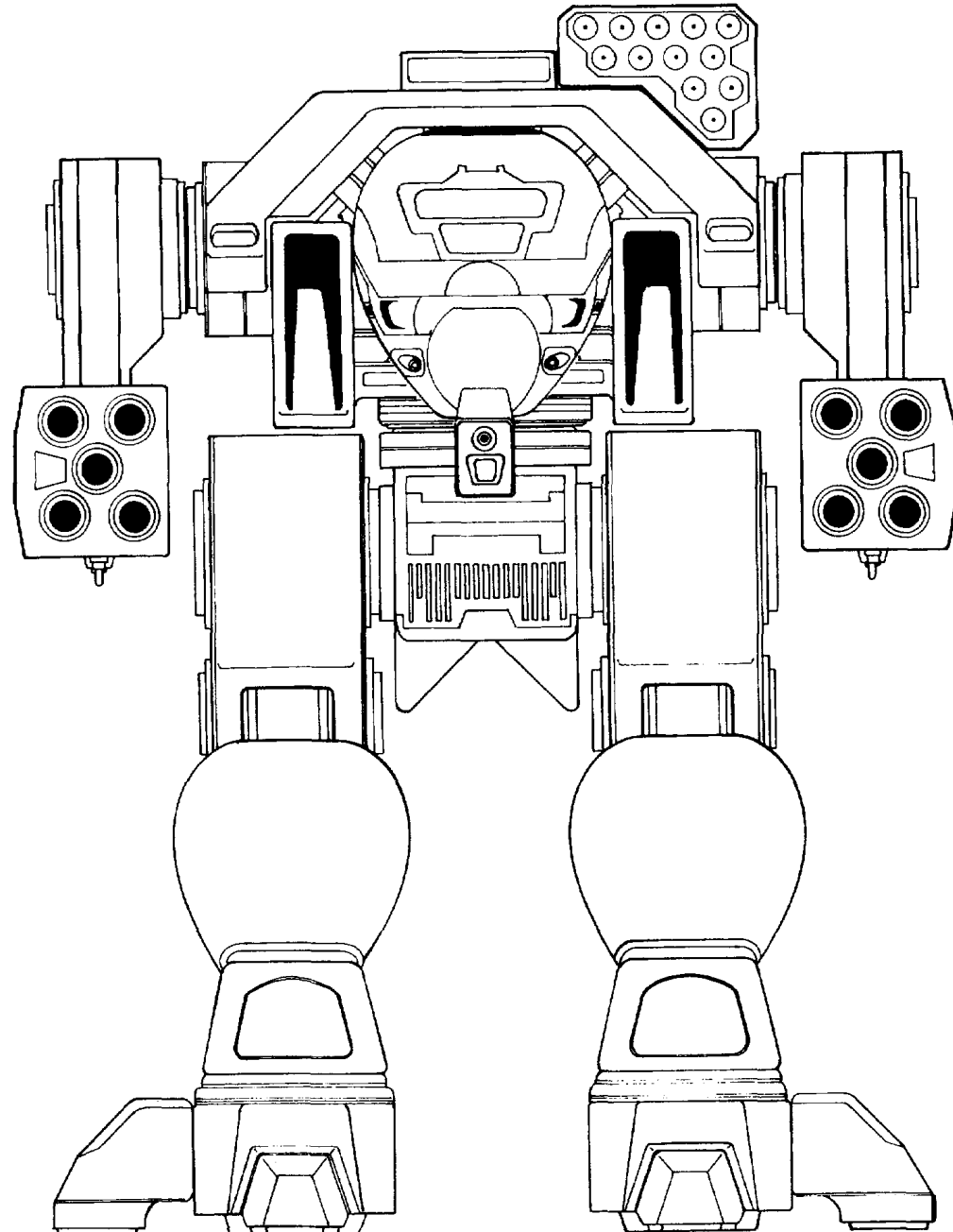

The military situation in the Successor States has changed greatly in the last year, because of the Clan invasion and for other reasons as well. Production has shown dramatic increases in quality and quantity, the combined result of several converging factors. Strategy, tactics, and deployment have changed as well. Perhaps the most troubling change is the apparent new era of cooperation among the states of the Inner Sphere, which works against the aims and efforts of Our Blessed Order.

PRODUCTION

The lessons of the Fourth Succession War and the War of 3039 gave the Successor States good reason to step up 'Mech production. In the years of peace that followed, the Great Houses profited from the chance to regroup and set new priorities. House Kurita was especially busy. The Draconis Combine created brand-new units, found ways to strengthen its military with support from the powerful yakuza crime syndicates, and carried out such ingenious deployments in the War of 3039 that it took the mighty Federated Commonwealth by surprise. (The Combine's use of Star-League designs provided by Our Blessed Order also played havoc with House Davion and Steiner's intention of simply rolling over what they believed was a seriously weakened foe.) The Draconis Combine has also been working on new BattleMech designs, as well as making full use of captured Davion 'Mech factories on Marduk and Quentin.

The design work on a Kurita version of the Steiner *Hatchetman* has been in progress for years, as has the transition from the *Dragon* to the *Grand Dragon*. Though progress on the *Hatchetman* has been slow, the *Grand Dragon's* successes certainly offset it. Two other designs of more recent vintage, the *Wolf Trap* and the *Mauler*, also show promise. As for the Combine's efforts to upgrade the altered Star League 'Mechs they obtained from Our Blessed Order during the 3039 War, ROM agents have been unable to ascertain to what extent they have been successful.

The other new designs have sprung from Banzai Weapon Design Company in the Federated Commonwealth. These projects, too, were years in the planning. Designs such as the *Caesar* and *Axman* were already well underway at the time that the

Successor States began suddenly to unlock the secrets of Star League technology. Work on these designs has paralleled the merger of Steiner and Davion forces into the army of the Federated Commonwealth. Joint planning has given higher priority to certain designs, namely the *Atlas*, *Cataphract*, *Commando*, *Enforcer*, *Hatchetman*, *JagerMech*, *Valkyrie*, *Victor*, *Wolfhound* and *Zeus*, all of which the Federated Commonwealth factories are producing in ever-greater numbers.

The Free Worlds League, relatively untouched by recent wars, has increased its production significantly. Though the 'Mech forces of House Marik have grown only modestly, other states and mercenary units depend increasingly on factories in the Free Worlds League for both spare parts and replacement 'Mechs. It was the ability to purchase 'Mechs from the Free Worlds League that helped the Draconis Combine vastly swell its number of 'Mech regiments without a comparable increase in BattleMech production. The Federated Commonwealth, too, was able to make up massive losses from the Fourth Succession War and the War of 3039 partly with Marik 'Mechs. The F-C then went on to raise the status of countless regiments to Regimental Combat Teams and simultaneously create dozens of new F-C 'Mech and armor regiments, further straining its own production. The Capellan Confederation, cut in half by the Fourth Succession War and with its military in ruins, had also lost so many 'Mech factories that its production was virtually stalled. Once again, it was the impressive production muscle of the Free Worlds League that allowed this shattered star empire to rebuild.

With Regular House units consuming so much of the 'Mech factory production, many mercenary units have turned to the 'Mech factories of Periphery states, primarily the Taurian Concordat, but also the Outworlds Alliance and the Magistracy of Canopus. Though these producers were a bit slow in gearing up, they have since increased production to meet this unanticipated groundswell of demand.

Lastly, the Clan invasion has given the powers of the Inner Sphere a new impetus for increasing production. In an unprecedented display of cooperation, the House Lords have been working together to meet the threat from beyond the Periphery. Putting fears of industrial espionage aside, the executives of the pri-

mary weapons producers have toured the facilities of formerly hostile realms to consult with one another on streamlining procedures. Perhaps the best example was the joint effort of the Draconis Combine and the Federated Commonwealth to help the Free Rasalhague Republic get back on its feet.

With the Wolf Clan pushing forward at a rapid pace in 3050, the Rasalhague Defense Ministry saw its only 'Mech factory on New Oslo directly in the line of attack. Unable to stop the Clans or even to slow their pace, the Rasalhague Defense Ministry disassembled the New Oslo facility and moved its equipment further from the front lines, to the planet of Satalice. Though this prevented the capture of valuable equipment, the Rasalhagians lacked the resources and knowhow to put the plant back into operation quickly. With the lull in the fighting and the new attitude of cooperation, however, technicians from the Federated Commonwealth and Draconis Combine have helped engineers from Gorton, Kingsley, and Thorpe Enterprises to rebuild their factory and even improve upon it.

TECHNOLOGY

The deployment of the Com Guards in the 3030s was the biggest change in Inner Sphere military technology since the fall of the Star League and the exodus of General Aleksandr Kerensky. Though the House Lords sought to copy our 'Mech designs and to steal their secrets, our exceptional security procedures kept our technological edge, even from House Kurita, to whom we supplied some altered versions of Com Guards materiel.

Though we could once claim superior military technology, we can no longer. The ability of the other Great Houses to copy some of the Star League designs to which only we had access is not the main cause of this deplorable state of affairs. The erosion of our technological superiority is also due to the efforts of Hanse Davion, main threat to peace and primary enemy of Our Order. We still do not know how the Federated Suns was able to circumvent our Interdiction Order during the Fourth Succession War, but we suspect some mysterious (though surely inferior) system performed the services of our HyperPulse Generators. ROM agents have still been unable to pinpoint this technology, but some incidents clearly indicate an alternative

form of interstellar communication. The other source of technology is continuing research at the New Avalon Institute of Science, another tool of Hanse Davion. NAIS researchers produced the flawed myomer that gave House Liao its embarrassing defeat on Sian. Research into the successful practical application of this improved 'Mech muscle continue at New Avalon, Sian, and probably elsewhere. Though no working model has appeared, these researchers have made some progress in using new compounds.

Davion is not chiefly responsible for the Inner Sphere's main advances in technology, however. That dubious honor goes to Colonel Grayson Death Carlisle, whose Gray Death Legion recovered a Star League computer memory core on the planet Helm just days before the start of the Fourth Succession War. Despite extraordinary efforts by Primus Julian Tjepolo and Primus Myndo Waterly, Colonel Carlisle has made good on his announced intention to spread the secrets of this library core throughout the Inner Sphere. Though it has taken two decades for scientists to understand and apply this technology, 'Mechs with enhanced capabilities have begun to appear throughout the Successor States. In the midst of the Fourth Succession War, the elite Com Guards unit Blake's Vision III-sigma posed as House Liao's Death Commandos to stage a raid on the New Avalon Institute of Science and destroy the library core. Had this raid been successful, we would have followed through with contingency plans to destroy other copies being studied by other Houses not as far along in their research.

After our failure to destroy the Gray Death memory core, the NAIS slowly but surely continued to decode the technology bit by bit, starting with the development of a heat exchanger with twice the capacity of a normal heat sink. Though not as effective as the design used on Clan 'Mechs, these Freezers, as they were tagged, soon gained widespread use. Research at NAIS continued at a frenzied pace, but the scientists in the Draconis Combine were not far behind in making parallel discoveries. Lacking enough production facilities to take full advantage of their successes, the Kuritans shared the secrets with their ally, the Free Worlds League, in exchange for production from Marik factories.

This situation lasted about four years, with the Federated Commonwealth, Draconis Combine, and Free Worlds League frantically upgrading old designs and retooling factories as fast as their engineers could move. Then came clearance for Gorton, Kingsley, and Thorpe Enterprises, parent company of Alshain Weapons and a major weapons producer for the Draconis Combine, to share some of this technology with the Free Rasalhague Republic's New Oslo 'Mech factory. The spread of information to HildCo Interplanetary in the St. Ives Compact left only the Capellan Confederation and the Periphery states out in the cold.

Fortunately for House Liao, the Capellans had something to trade. Capellan scientists had continued research on the booby-trapped myomer and had achieved limited success in identifying another compound with the same valuable properties but not the same vulnerability. In 3046, House Liao traded its knowledge of the improved myomer for House Marik's help in resuming 'Mech production and incorporating the technology that had already reached the rest of the Inner Sphere.

Though still existing in relatively small numbers, improved 'Mech designs are emerging from factories throughout the Successor States, including even Rasalhague's new factory on Satalice. Certain weapons factories have achieved such high levels of production that the assembly plants, still in the process of retooling, cannot use their entire output. Such surplus advanced lasers and other weapons are being issued to units as field modification kits and retrofitted onto older 'Mech designs. Though the technology cannot equal the Star League's precision manufacturing techniques, the new Inner Sphere 'Mechs often possess excellent design concepts, sometimes producing a weapons mix that is superior to the original Star League design even though the equipment does not quite meet Terran Hegemony standards.

These 'Mechs were not available in time to meet the initial Clan invasion, but that offensive has provided a powerful prod for the Successor States to keep their modernization plans in high gear. These improved Inner Sphere 'Mechs are still no match for those of the Clans, but they definitely give the Successor States new and better odds. The invasion also appears to

have given the Successor States, bitter rivals only a few years ago, reason to set aside their differences and work together against a common foe.

Precentor Martial Anastasius Focht's mission to the Clans opened up new areas of possible influence, but that cannot offset the Com Guards' loss of technological superiority. In the post-Succession War era, Primus Waterly's well-laid plans made ComStar and the Com Guards admired, appreciated, and yet feared in every realm. Our Order's good deeds and omnipresence opened the door to a number of new strategies for increased power and influence. The Com Guards are still powerful, but we have lost our margin of technological superiority. And our very omnipresence has become a liability with the dispersal of our military over so many worlds.

The Com Guards' non-involvement in the Inner Sphere's war against the Clans has made the Successor States again suspicious of our Order. ComStar's attempts to help the people within the Clans' territory has been misunderstood by the Lords of the Great Houses, who have become more guarded than ever in their dealings with ComStar. On most worlds, garrison units keep a close watch on the Com Guards detachments protecting the HPG stations.

STRATEGY

The appearance of a new enemy has provided the impetus for Inner Sphere strategists to reevaluate old ways of fighting wars. Using inferior equipment has forced the generals to come up with alternatives to standard power tactics.

In the first wave of the Clan invasion, the range advantage of their 'Mechs presented the gravest problem the Inner Sphere armies had to face, and it remains the focus of the Successor States' alternative tactics. Though reduced to fighting from the midst of sandstorms and hiding in swamps draped with foil, the troops of the Inner Sphere have been able to hand the Clans their first defeats.

With the obvious collusion among the leaders evidenced by the "secret" summit meeting on Outreach, to which our leaders were not invited, it is expected that the Successor States will have new surprises waiting for the Clans' renewal of their offensive.

DEPLOYMENT

Despite the House Lords' mistrust of Our Blessed Order and their attempts to conceal new deployment, their troop movements to meet a new wave of invasions are transparent and too large to hide. Even while the invasion was still progressing at full-tilt, the Federated Commonwealth allocated great numbers of JumpShips and DropShips to massing troops on Sudeten, ready to respond to new attacks or make a counterstrike into Clan territory. Besides the four regiments that made the successful strike on Twycross, the three regiments of the mercenary Eridani Light Horse and a dozen Federated Commonwealth regiments gathered on Sudeten. They were the Fourth and Eighth Deneb Light Cavalry, the Third Royal Guards, the Seventeenth and Twentieth Arcturan Guards, the Tenth, Eleventh, Nineteenth, and Thirty-Second Lyran Guards, and the Eleventh and Twelfth F-C Regiments.

The Draconis Combine also stripped the Skye-Dieron border, even leaking information about this weakened region to show House Kurita's concern about the advance of the Clans. Davion responded in kind by redeploying his own border forces to better meet the threat of the Clans, but he also covered his underbelly somewhat by moving ten regiments, mostly mercenaries, from the Crucis March to the Skye March. The DCMS units are more difficult to track because neither our Order nor any other state has been able to pinpoint Combine troop strength since before the War of 3039, and now the Kanrei has deepened the deception by renaming units to trick the Clans. Restrictions on the Com Guards' movements have prevented ROM agents from obtaining better intelligence.

Cooperation among the Successor States has probably made their knowledge of the Clans almost as good as our own. They have certainly shared information about worlds lost, equipment, troop strength, and strategy. Our inside information about customs, Clan rivalry, and possible motivations is probably our only edge over the House Lords.





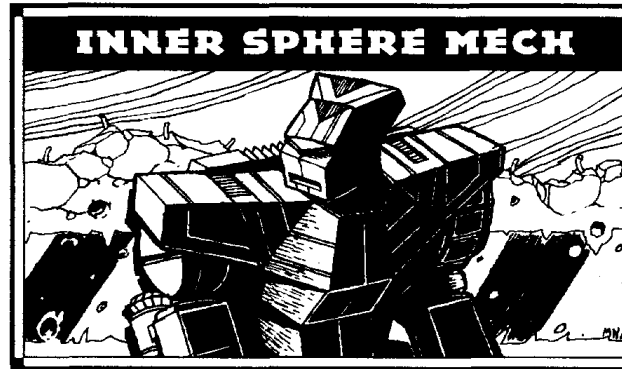

OVERVIEW

Formerly rare in the Inner Sphere, the *Flea* has been appearing in increasing numbers in the past decade, mostly in the regiments of the mercenary unit Wolf's Dragoons, which have been rebuilding since the devastation of the Fourth Succession War and may now exceed their former strength. Earthwerks Incorporated appears to be producing a version incorporating recovered technology, perhaps under exclusive contract to the Dragoons.

This model takes advantage of its lighter endo steel structure to replace the earlier *Flea*'s medium lasers with more potent medium pulse lasers. Because the Dragoons use the *Flea* far more often in a reconnaissance role than as an antipersonnel 'Mech, Earthwerks dropped the pair of SperryBrowning machine guns, replacing them with Myomer Accelerator Signal Circuitry. Though dangerous to use, the MASC technology is sometimes the only way for the *Flea* to escape a bad situation because it lacks the speed and jumping ability of many other light 'Mechs.

It appears that the Earthwerks plants on Ascuncion and Bernardo will soon complete their production run for the Dragoons. It remains to be seen whether Earthwerks will produce the 'Mech for general sale or will cease production of the model.

Mass: 20 tons
Chassis: Earthwerks Trooper II Endo Steel
Power Plant: GM 120
Cruising Speed: 64 kph
Maximum Speed: 97 kph, 130 kph w/ MASC
Jump Jets: None
Jump Capacity: None
Armor: Livingston Ceramics
Armament:
 2 Martell Medium Pulse Lasers
 1 Olympian Flamer
 2 Martell Small Lasers
Manufacturer: Earthwerks Incorporated
Primary Factory: Ascuncion, Bernardo
Communications System: Neil 2000
Targeting and Tracking System: Dalban HiRez-B

Type: Flea
Technology Base: Inner Sphere
Tonnage: 20

Equipment		Mass
Internal Structure:	Endo	1
Engine:	120	4
Walking MP:	6	
Running MP:	9 (12)	
Jumping MP:	0	
Heat Sinks:	10	0
Gyro:		2
Cockpit:		3
Armor Factor:	48	3
	<i>Internal Structure</i>	<i>Armor Value</i>
Head	3	5
Center Torso	6	8
Center Torso (rear)		3
R/L Torso	5	5
R/L Torso (rear)		3
R/L Arm	3	4
R/L Leg	4	4

Weapons and Ammo	Location	Critical	Tonnage
Medium Pulse Laser	LA	1	2
Medium Pulse Laser	RA	1	2
Flamer	CT	1	1
Small Laser	LT (R)	1	.5
Small Laser	RT (R)	1	.5
MASC	CT	1	1

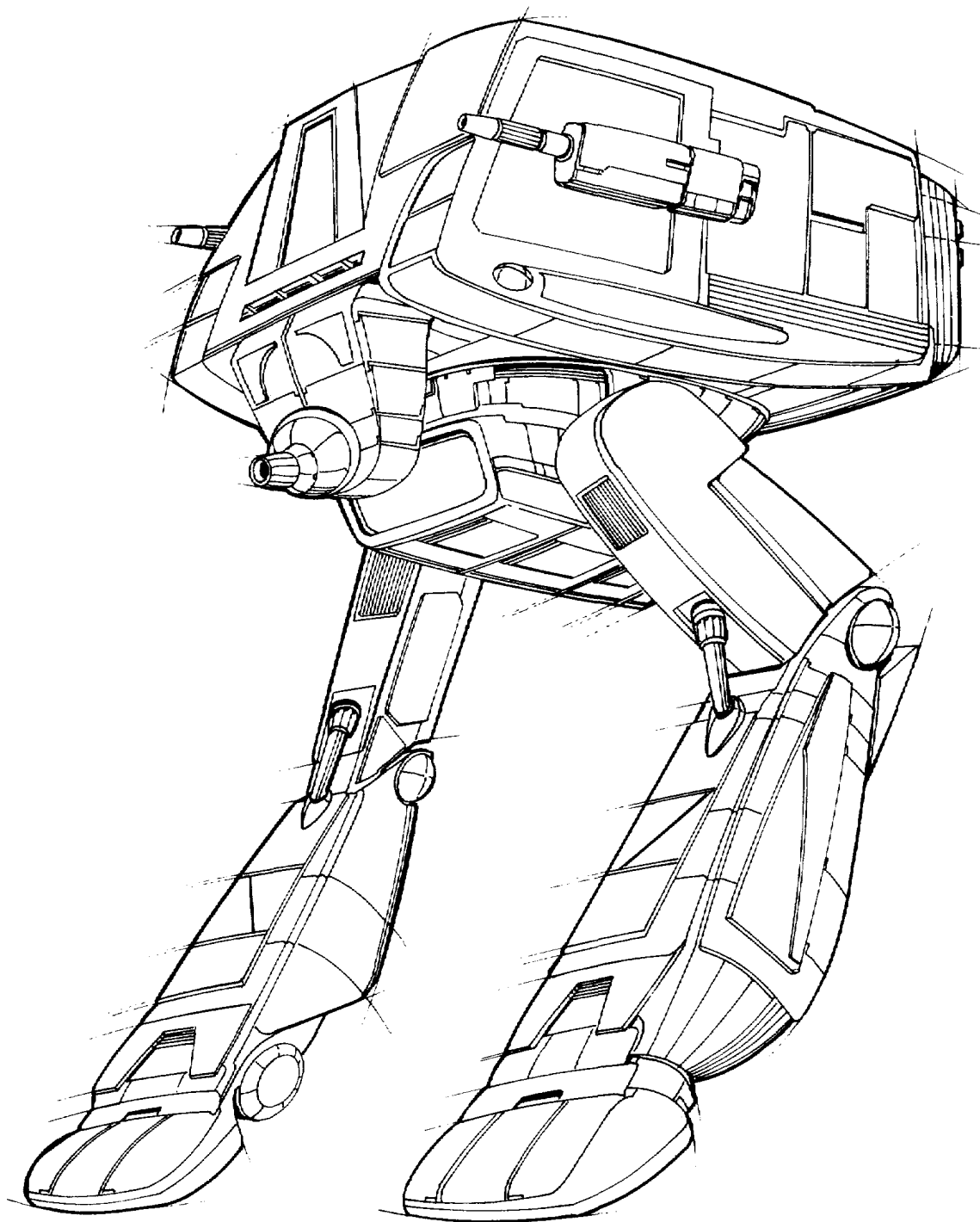



OVERVIEW

A design that has long been out of favor, the *Hornet* was one of the first 'Mechs to use recovered technology in the hope of improving its performance. The modifications were made at the high-security Kallon factory on the planet Talon in the Wernke system. The HNT-171 model shown has appeared in limited numbers in Federated Commonwealth units, mostly in the Sarna March, apparently as part of a field test. Wolf's Dragoons, which always deployed the *Hornet* in greater numbers than did House Davion, may be using a different model, but ComStar has been unable to confirm that.

The Federated Commonwealth version is far more effective than the old HNT-151. It incorporates the lighter endo steel construction, combined with ferro-fibrous armor and Cellular Ammunition Storage Equipment (CASE). The 171 model carries half a ton less armor than the 151, but has virtually the same amount of external protection and significantly more protection against an ammunition explosion.

The MainFire Point Defense anti-missile system gives the *Hornet* better defense against enemy missiles at the cost of an ineffective small laser. It remains to be seen, however, whether the improved *Hornet* will prove more valuable on the battlefield than its predecessor.

Mass: 20 tons
Chassis: Corean Model KL77 Endo Steel
Power Plant: Hermes 100
Cruising Speed: 54 kph
Maximum Speed: 86 kph
Jump Jets: Pitban LFT-50
Jump Capacity: 90 meters
Armor: StarGuard CIV Ferro-Fibrous with CASE
Armament:
 1 Holly LRM-5 Missile Rack
 1 MainFire Point Defense Anti-Missile System
 1 Martell Medium Laser
Manufacturer: Kallon Weapon Industries
Primary Factory: Talon (Wernke system)
Communications System: Tri-Word Duplex 4880
Targeting and Tracking System: Daban HiRez II

Type: Hornet
Technology Base: Inner Sphere
Tonnage: 20

Equipment		Mass
Internal Structure:	Endo	1
Engine:	100	3
Walking MP:	5	
Running MP:	8	
Jumping MP:	3	
Heat Sinks:	10	0
Gyro:		1
Cockpit:		3
Armor Factor:	63	3.5
	<i>Internal Structure</i>	<i>Armor Value</i>
Head	3	7
Center Torso	6	8
Center Torso (rear)		4
R/L Torso	5	8
R/L Torso (rear)		2
R/L Arm	3	6
R/L Leg	4	6

Weapons and Ammo	Location	Critical	Tonnage
LRM 5	RT	1	2
Ammo (LRM) 48	LT	2	2
Anti-Missile System	H	1	.5
Ammo (Anti-Missile) 12	LT	1	1
CASE	LT	1	.5
Medium Laser	RA	1	1
Jump Jet	CT	1	.5
Jump Jet	LT	1	.5
Jump Jet	RT	1	.5

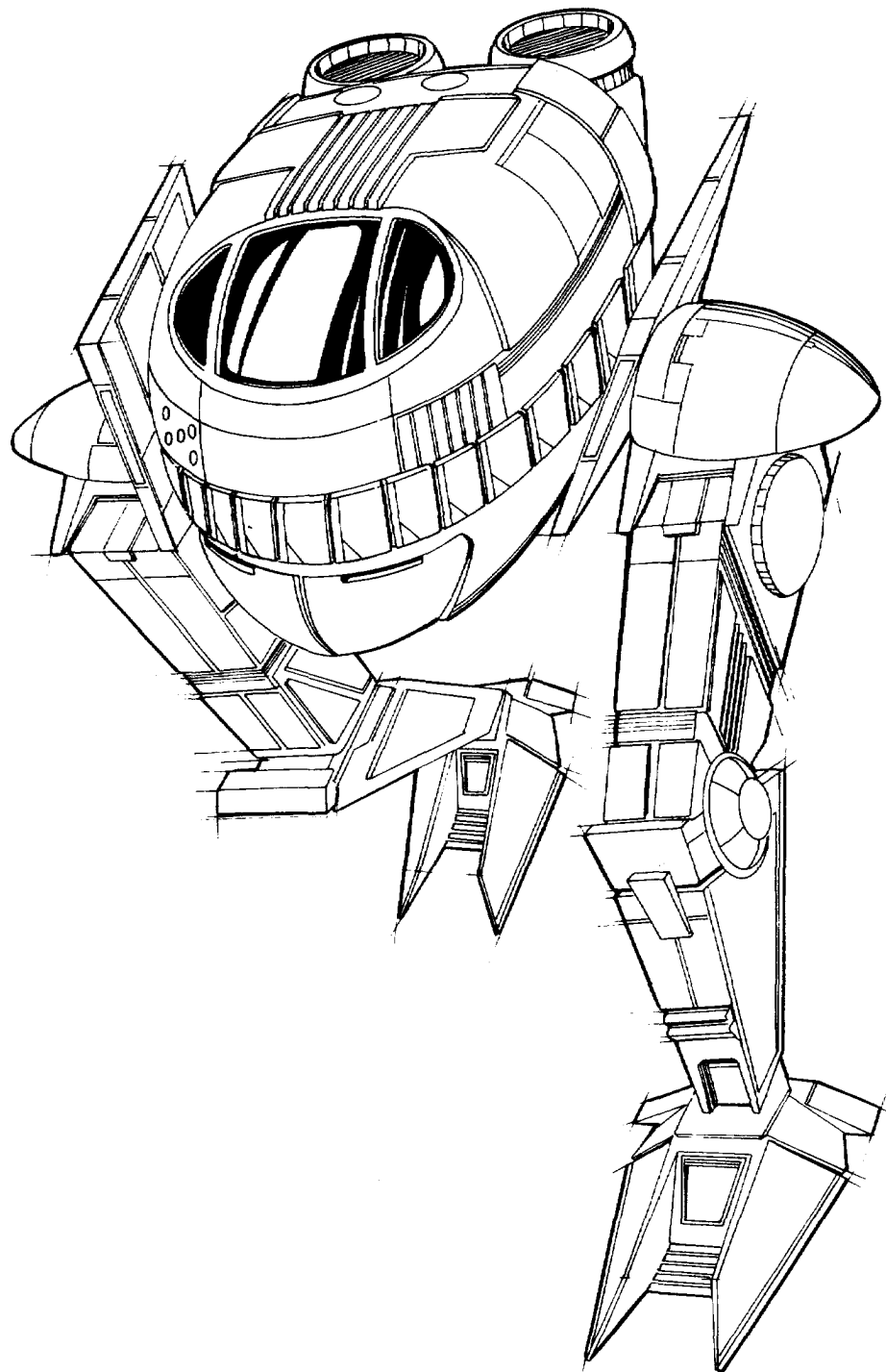

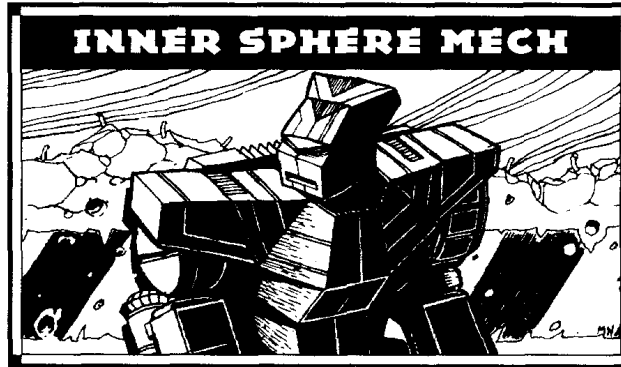

OVERVIEW

The *Mercury* may have been the most important 'Mech built during the Star League era, but nobody knew its true worth until three centuries later. It was unveiled in 2742, and few remained in the Inner Sphere after General Aleksandr Kerensky departed for unknown space with the bulk of the Star League Army. The value of this 'Mech's modular design was lost on the Successor States, but not on the heirs of Kerensky. This 'Mech clearly inspired the OmniMechs that have so recently terrorized the Inner Sphere.

Using a basic structure, power plant and main torso, the *Mercury* can support many combinations of weapons systems and other equipment. The most obvious advantage of this modular construction is the ease of maintenance and repair. Recovery from battle damage is a simple matter. Of almost equal importance is the ability to vary the 'Mech's weapon mix, tailoring it for a specific mission and keeping the enemy guessing about the *Mercury's* abilities.

Though not in service with the Successor States or mercenary units, the *Mercury* is common in the Com Guards, especially with The Grace of Thought IV-xi and Straight Words IV-epsilon. Drawing mostly reconnaissance and intelligence missions, these 'Mechs differ from the usual Equipment Package 99 variety of *Mercury* seen most often in the Star League Army. The Com Guards' *Mercury* MCY-97 carries the Beagle probe for enhanced detection capability and Myomer Accelerator Signal Circuitry for fast getaways, giving up a medium laser and a small laser to make room. Though a weak fighter, this model is a premier reconnaissance 'Mech.

Mass: 20 tons
Chassis: Bergan MXII
Power Plant: LTV 160
Cruising Speed: 86 kph
Maximum Speed: 130 kph, 173 kph w/ MASC
Jump Jets: None
Jump Capacity: None
Armor: Mitchell-091 Ferro-Fibrous
Armament:
 1 Martell Medium Laser
 1 Hessen IX Small Laser
Manufacturer: Mitchell Vehicles
Primary Factory: Graham IV
Communications System: DataTech 401
Targeting and Tracking System: Skyhunter IV with Beagle Probe

Type: Mercury
Technology Base: Inner Sphere
Tonnage: 20

Equipment		Mass
Internal Structure:		2
Engine:	160	6
Walking MP:	8	
Running MP:	12 (16)	
Jumping MP:	0	
Heat Sinks:	10	0
Gyro:		2
Cockpit:		3
Armor Factor:	54	3
	<i>Internal Structure</i>	<i>Armor Value</i>
Head	3	5
Center Torso	6	7
Center Torso (rear)		4
R/L Torso	5	6
R/L Torso (rear)		2
R/L Arm	3	5
R/L Leg	4	6

Weapons and Ammo	Location	Critical	Tonnage
Medium Laser	RA	1	1
Small Laser	CT	1	.5
Beagle Active Probe	LT	2	1.5
MASC	CT	1	1

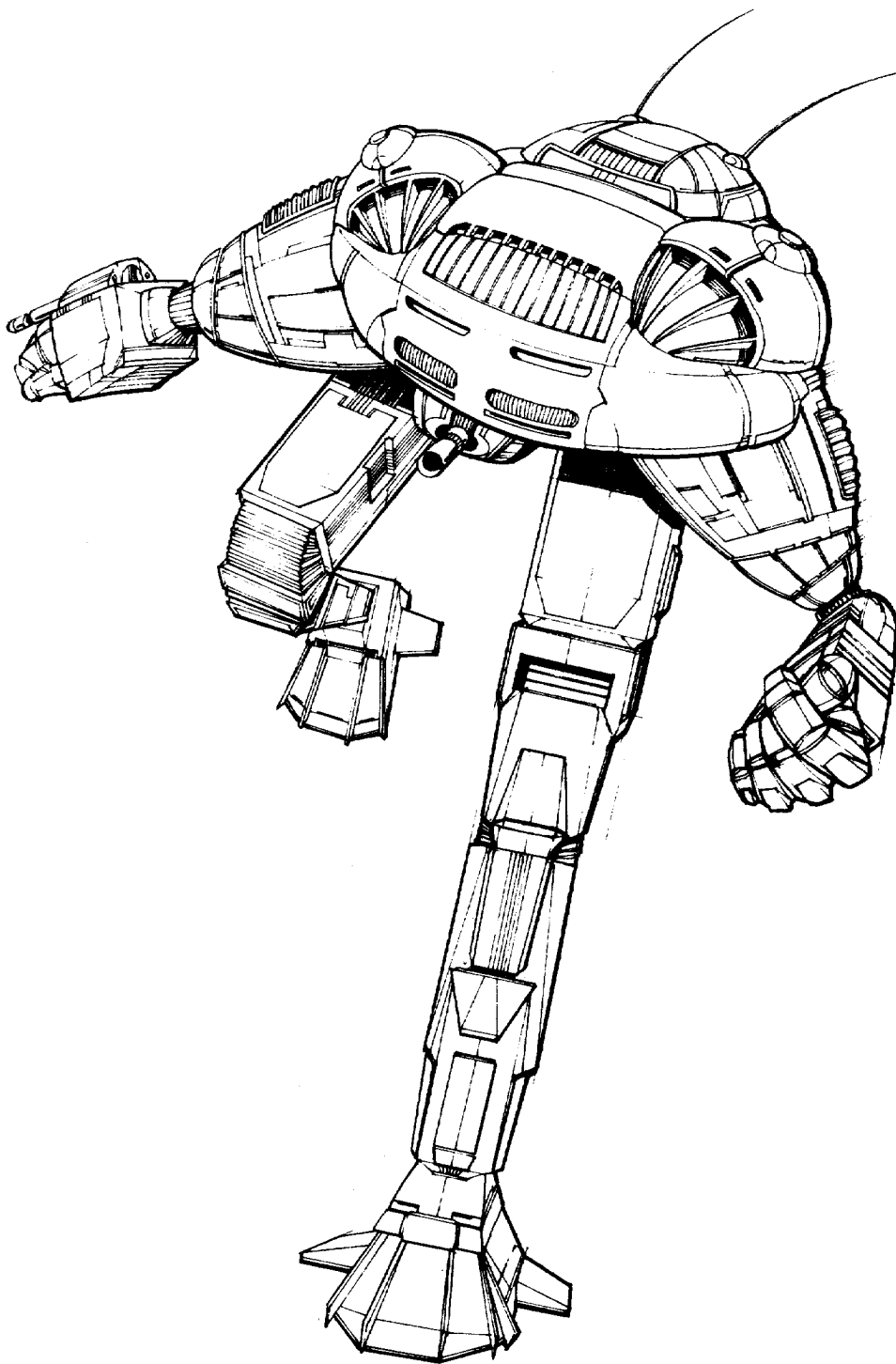



OVERVIEW

One of the first BattleMechs to feature endo steel in the construction of its skeleton, the *Thorn* debuted in the Terran Hegemony Armed Forces to tremendous hype. Though technicians and MechWarriors agreed that endo steel construction offered obvious advantages, the *Thorn* itself received mixed reviews.

Supporters of the design point out that the *Thorn* packs more punch per ton and carries more armor than other 'Mechs in its weight class. In a toe-to-toe slugfest, the *Thorn* can usually reduce an opponent of equal weight to scrap within minutes. Front-line units using the *Thorn* consider a higher survivability rate an acceptable trade-off for decreased maneuverability. In addition, sensible weapon placement and ease of maintenance have earned the design high marks from technicians. Service crews can actually climb into the 'Mech's arms and legs and work on repairs from the inside.

Opponents of the *Thorn* note that a 'Mech cannot hit what it cannot reach. Though the 120-class engine gives the *Thorn* respectable speed, its lack of jump jets handicaps the *Thorn's* performance against other light 'Mechs. The Zeus long-range missile system only partially offsets the diminished pursuit ability.

The *Thorn's* main armament consists of two efficient medium lasers. One of them, installed directly under the pilot's feet, makes repeated firing of the weapon uncomfortable for the pilot, though the *Thorn's* technical specs classify it as a cool-running machine.

The Zeus long-range missile system offers accurate weapons fire, and the arm mount allows the pilot to switch targets quickly. The system is particularly vulnerable to damage in hand-to-hand combat, but the entire system can be replaced in just a few hours. Unfortunately, the manufacturers incorporated an average-quality missile-feed system into the design. If the loader is damaged, ammo may become lodged in the upper arm and detonate if the 'Mech takes additional damage. The explosion will destroy the limb.

Mass: 20 tons
Chassis: Chariot Type II
Power Plant: GM 120
Cruising Speed: 65 kph
Maximum Speed: 97 kph
Jump Jets: None
Jump Capacity: None
Armor: Armorscale with CASE
Armament:

1 Zeus LRM-5 Missile Rack
 2 Hellion Spitfire Medium Lasers
Manufacturer: Ford Military Limited
Communications System: Opus I Ultrabeam
Targeting and Tracking System: Orion 80

Type: Thorn
 Technology Base: Inner Sphere
 Tonnage: 20

Equipment		Mass
Internal Structure:	Endo	1
Engine:	120	4
Walking MP:	6	
Running MP:	9	
Jumping MP:	0	
Heat Sinks:	10	0
Gyro:		2
Cockpit:		3
Armor Factor:	72	4.5
	<i>Internal Structure</i>	<i>Armor Value</i>
Head	3	9
Center Torso	6	8
Center Torso (rear)		4
R/L Torso	5	6
R/L Torso (rear)		4
R/L Arm	3	6
R/L Leg	4	8

Weapons and Ammo	Location	Critical	Tonnage
LRM 5	RA	1	2
Ammo (LRM) 24	RT	1	1
CASE	RT	1	.5
Medium Laser	H	1	1
Medium Laser	LA	1	1

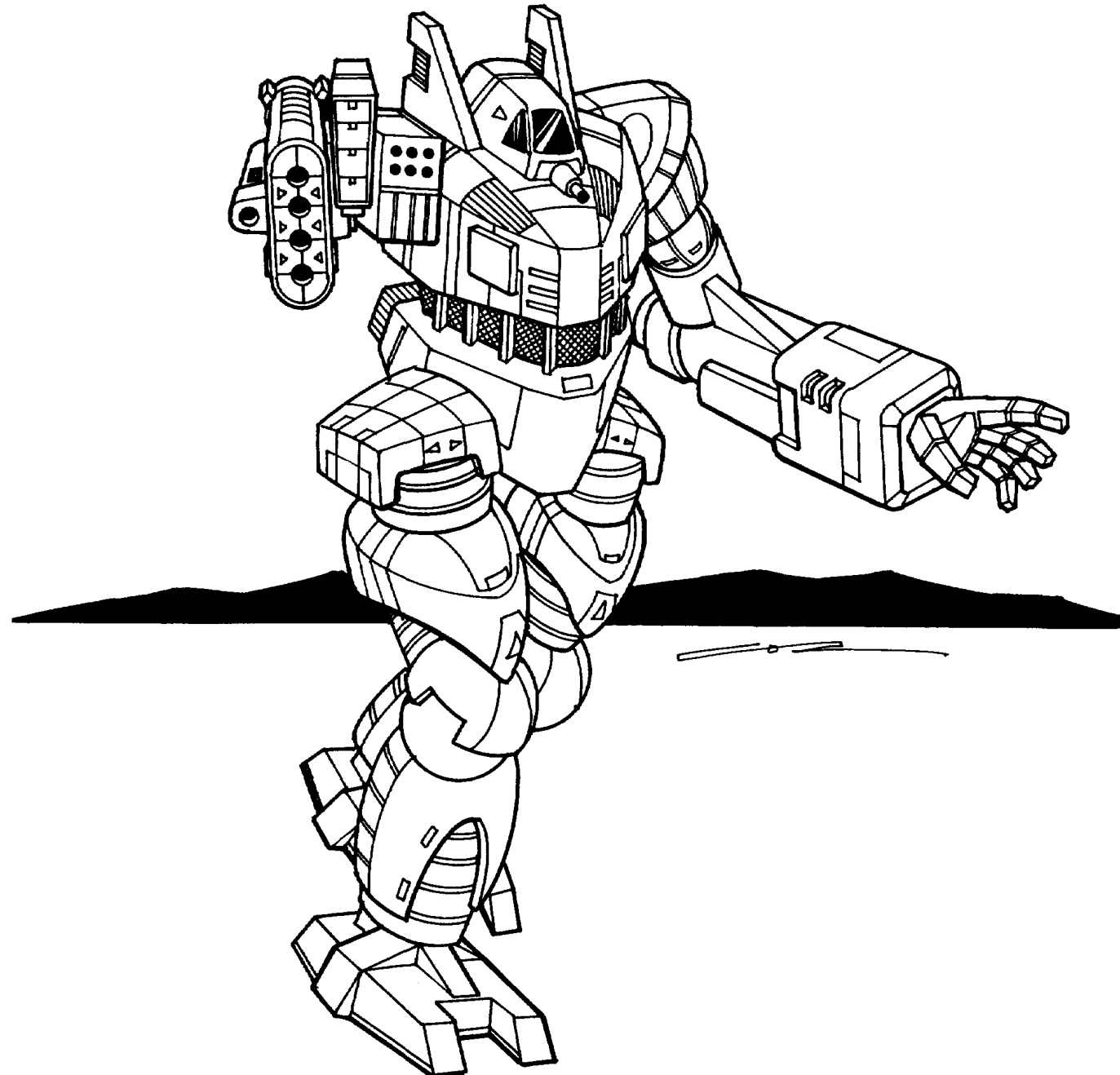

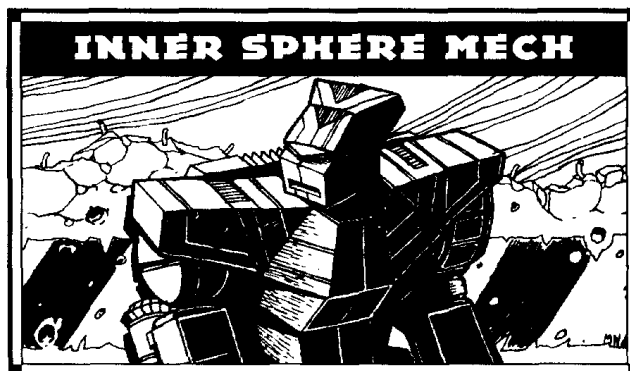

OVERVIEW

The *Commando* and the *Valkyrie* have been designated as the standard light 'Mechs of the Federated Commonwealth for the second half of the thirty-first century. Though production of other designs continues, these two light 'Mechs are expected to appear in ever-greater numbers. Just beginning production at Coventry Metal Works, the **COM-5S *Commando*** is a model of efficiency. It utilizes Foundation Ultralight endo steel and Lexington High Grade ferro-fibrous armor so that more of its mass can be devoted to weapons and other systems. Though the 'Mech carries only three tons of armor, its ferro-fibrous composition and the addition of Cellular Ammunition Storage Equipment offset this potential weakness.

The new *Commando's* greatest efficiency lies in its two missile systems. It substitutes a Coventry SRM-6 rack for the original design's ancient Shannon Six-Shooter, and it combines the SRM-6 with an Artemis IV fire-control system to improve accuracy. It also replaces the Coventry 4-Tube missile system with the new Coventry T4H short-range Streak missile launcher. Though only a dual rack, the T4H uses its ammunition much more efficiently than its predecessor by withholding fire until the targeting system achieves a lock.

Lacking Star League technology, Vandenberg Mechanized Industries continues to produce the older-design *Commando* COM-2D at its factory on Illiushin in the Taurian Concordat.

Mass: 25 tons
Chassis: Foundation Ultralight Endo Steel
Power Plant: GM 150
Cruising Speed: 64.8 kph
Maximum Speed: 97.2 kph
Jump Jets: None
Jump Capacity: None
Armor: Lexington Ltd. High Grade Ferro-Fibrous with CASE
Armament:
 1 Coventry 90 mm SRM-6 Missile Rack
 1 Coventry T4H Streak SRM Missile Rack
 1 Defiance B3M Medium Laser
Manufacturer: Coventry Metal Works
Primary Factory: Coventry
Communications System: Cyclops 14
Targeting and Tracking System: Cyclops Multi-Tasker 10
 with Artemis IV System

Type: Commando
Technology Base: Inner Sphere
Tonnage: 25

Equipment		Mass
Internal Structure:	Endo	1.5
Engine:	150	5.5
Walking MP:	6	
Running MP:	9	
Jumping MP:	0	
Heat Sinks:	10	0
Gyro:		2
Cockpit:		3
Armor Factor:	54	3
	<i>Internal Structure</i>	<i>Armor Value</i>
Head	3	5
Center Torso	8	8
Center Torso (rear)		3
R/L Torso	6	6
R/L Torso (rear)		2
R/L Arm	4	5
R/L Leg	6	6

Weapons and Ammo	Location	Critical	Tonnage
SRM 6	CT	2	3
Ammo (SRM) 30	RT	2	2
Artemis IV FCS	H	1	1
Streak SRM 2	RA	1	1.5
Ammo (Streak) 50	RT	1	1
CASE	RT	1	.5
Medium Laser	LA	1	1

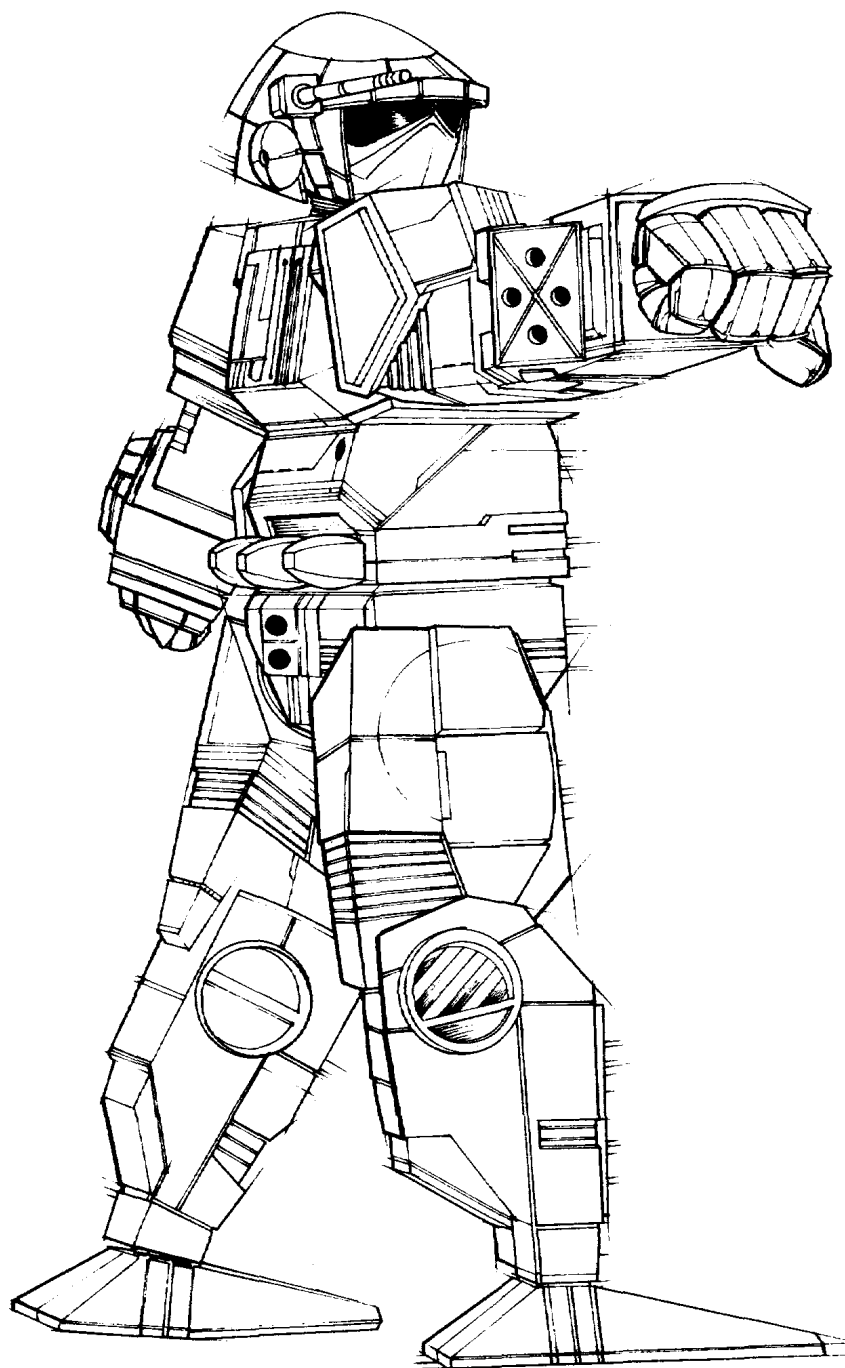



OVERVIEW

Introduced in the spring of 2660, the quick, agile *Mongoose* soon became popular with Star League light lance commanders. Though originally designed for deep reconnaissance, commanders adapted the 'Mech to front-line duty based solely on the capabilities of the *Beagle* active probe. The *Beagle* and its associated central processing units could easily coordinate the activities of an entire light company. By 2668, the design served as the standard command 'Mech for all light and recon lances.

Designed to replace the venerable *Locust*, the *Mongoose* relied on ground speed rather than jump capacity for maneuverability. The 'Mech's armament is based entirely on energy weapons, making the *Mongoose* an ideal deep-recon 'Mech, raider or guerrilla fighter.

The internal structure of the *Mongoose* uses endo steel. That alloy's tremendous load-bearing ability and greater tensile strength allow the 'Mech's light skeleton to carry a heavy load of armor for its size. The *Mongoose*'s ferro-fibrous armor can withstand a direct PPC blast to the chest without the 'Mech taking internal damage and can stand up to the punishment most medium 'Mechs can deliver.

The laser systems are tried and dependable; those mounted in the center torso and head offer above-average accuracy by employing internal compensators that allow the *Mongoose* to aim precisely when moving at a full run.

The *Beagle* active probe, tucked into the left shoulder, may be the 'Mech's most important feature. With extended scanner range and a wider scanning-band range, the *Beagle* can detect and identify vehicles 16 percent faster than any other scanner and stores the target in its memory. Should the *Beagle* encounter the target again, it will remember the 'Mech's speed and damage, and even forecast a fighting style for the *Mongoose* pilot. This memory feature allows pilots to review any battle, testing for various results by modifying their 'Mech's actions.

The two standard *Mongoose* variants drop the *Beagle* probe, one in favor of a short-range missile rack, the other to add a set of flamers on each arm.

MON-66 MONGOOSE

Mass: 25 tons
Chassis: Kell/D
Power Plant: Nissan 200
Cruising Speed: 86 kph
Maximum Speed: 130 kph
Jump Jets: None
Jump Capacity: None
Armor: Mitchell GA3 Ferro-Fibrous
Armament:
 3 Sorenstein Medium Lasers
 1 Starflash Plus Small Laser
Manufacturer: Diplan 'Mechyards of Ozawa
Communications System: ON-5
Targeting and Tracking System: Beagle Active Probe

Type: Mongoose
Technology Base: Inner Sphere
Tonnage: 25

Equipment		Mass
Internal Structure:	Endo	1.5
Engine:	200	8.5
Walking MP:	8	
Running MP:	12	
Jumping MP:	0	
Heat Sinks:	10	0
Gyro:		2
Cockpit:		3
Armor Factor:	90	5
	<i>Internal Structure</i>	<i>Armor Value</i>
Head	3	9
Center Torso	8	12
Center Torso (rear)		4
R/L Torso	6	10
R/L Torso (rear)		2
R/L Arm	4	8
R/L Leg	6	12

Weapons and Ammo	Location	Critical	Tonnage
Medium Laser	RA	1	1
Medium Laser	LA	1	1
Medium Laser	CT	1	1
Small Laser	H	1	.5
Beagle Active Probe	LT	2	1.5

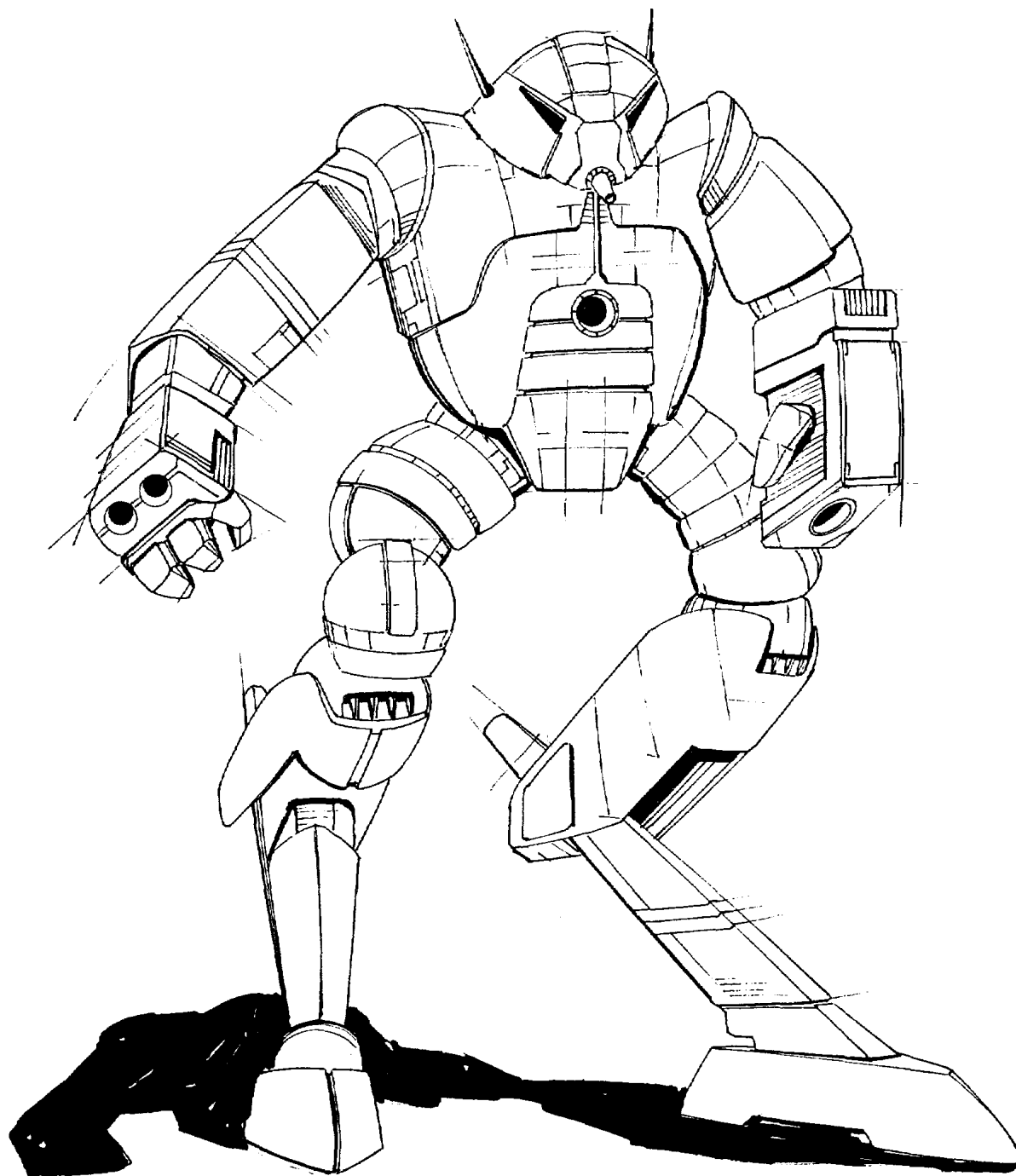



OVERVIEW

Rarely seen outside the regiments of the mercenary unit Wolf's Dragoons, the *Falcon* has not been produced in the Inner Sphere since a Marik raid destroyed the *Falcon* production facilities at a BattleMech factory on Hesperus during the First Succession War. The number of *Falcons* dropped steadily during the ensuing centuries of warfare, as those still in the field gradually succumbed to the lack of spare parts. The arrival of Wolf's Dragoons in 3005 marked the first appearance of mint-condition *Falcons* in the Inner Sphere since the beginning of the Succession Wars.

The mercenaries have managed to keep their *Falcons* in good repair, apparently with their own stockpile of spare parts, but no new *Falcons* have arrived to replace those lost in battle. Though there are rumors of a new model in the Dragoons' ranks, it is more likely that Colonel Jaime Wolf's regiments are using recovered technology to upgrade those *Falcons* already in service.

The most reliable reports indicate that the Dragoons are replacing the old SunGlow Type 1 medium laser with a Magna 400P medium pulse laser, a recovered-technology weapon generally available throughout the Inner Sphere. This model reportedly also replaces both machine guns with a SureFire 444 anti-missile system, another new weapon available over the counter to anyone with enough C-bills.

Mass: 30 tons
Chassis: Duralyte 296
Power Plant: GM 180
Cruising Speed: 64 kph
Maximum Speed: 97 kph
Jump Jets: PRS-60
Jump Capacity: 150 meters
Armor: Star Guard Type II
Armament:
 1 Magna 400P Medium Pulse Laser
 2 Omnicron 1000 Small Lasers
 1 SureFire 444 Anti-Missile System
Manufacturer: Stormvanger Assemblies, Light Division
Primary Factory: Caph
Communications System: Garret T20C
Targeting and Tracking System: Dynatec 150A

Type: Falcon
Technology Base: Inner Sphere
Tonnage: 30

Equipment		Mass
Internal Structure:		3
Engine:	180	7
Walking MP:	6	
Running MP:	9	
Jumping MP:	5	
Heat Sinks:	12	2
Gyro:		2
Cockpit:		3
Armor Factor:	96	6
	<i>Internal Structure</i>	<i>Armor Value</i>
Head	3	9
Center Torso	10	14
Center Torso (rear)		3
R/L Torso	7	12
R/L Torso (rear)		2
R/L Arm	5	8
R/L Leg	7	13

Weapons and Ammo	Location	Critical	Tonnage
Medium Pulse Laser	RA	1	2
Small Laser	RA	1	.5
Small Laser	LA	1	.5
Anti-Missile System	LT	1	.5
Ammo (Anti-Missile) 12	RT	1	1
Jump Jets	RT	2	1
Jump Jets	LT	2	1
Jump Jet	CT	1	.5

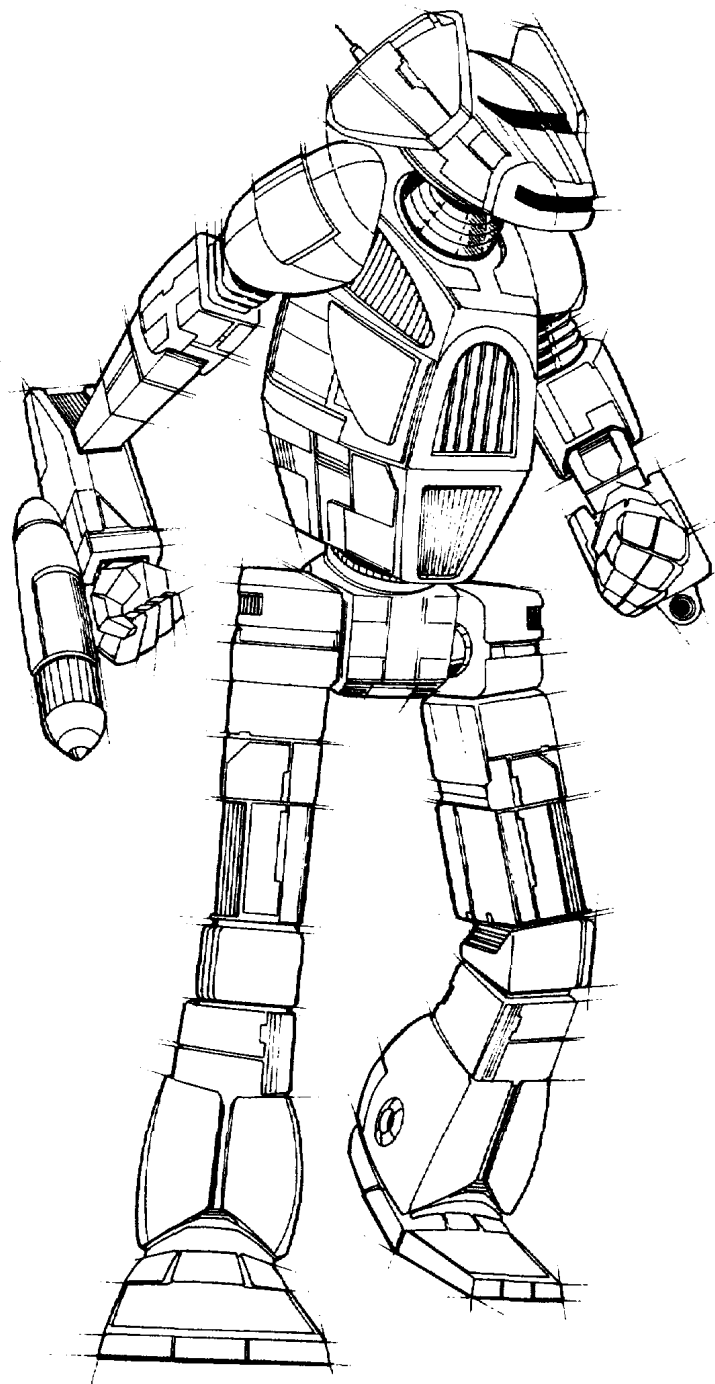

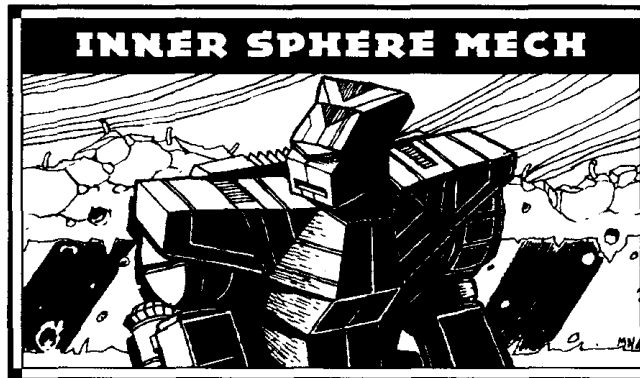

OVERVIEW

The *Firefly*, extinct except in the service of Wolf's Dragoons, has repeatedly proven its mettle against other reconnaissance 'Mechs, most recently in the Fourth Succession War. Third-hand reports picked up by a ROM agent in the St. Ives Compact indicate that the Dragoons are planning field modifications to further improve the *Firefly's* performance.

The field variation reportedly removes the *Firefly's* four small lasers, replacing them with a SureFire 444 Anti-Missile System. This gives the *Firefly* better protection, as does the addition of Cellular Ammunition Storage Equipment to protect the missile reloads and ammunition for the SureFire 444. The structural changes required to add CASE as a field modification cast doubt on the truth of this report. However, if the intelligence regarding this modification is correct, the Dragoons may have a factory in which to produce the *Firefly*.

Mass: 30 tons
Chassis: Earthwerks Firefly
Power Plant: GM 150
Cruising Speed: 54 kph
Maximum Speed: 86 kph
Jump Jets: Lexington Lifters
 Jump Capacity: 120 meters
Armor: StarSlab/1 with CASE
Armament:
 3 Martell Medium Lasers
 1 Coventry LRM-5 Missile Rack
 1 SureFire 444 Anti-Missile System
Manufacturer: Coventry/Earthwerks Combine
 Primary Factory: Terra
Communications System: Datcom 18
Targeting and Tracking System: Radcom TXX

Type: Firefly
Technology Base: Inner Sphere
Tonnage: 30

Equipment		Mass
Internal Structure:		3
Engine:	150	5.5
Walking MP:	5	
Running MP:	8	
Jumping MP:	4	
Heat Sinks:	10	0
Gyro:		2
Cockpit:		3
Armor Factor:	104	6.5
	<i>Internal Structure</i>	<i>Armor Value</i>
Head	3	8
Center Torso	10	15
Center Torso (rear)		5
R/L Torso	7	11
R/L Torso (rear)		3
R/L Arm	5	10
R/L Leg	7	14

Weapons and Ammo	Location	Critical	Tonnage
Medium Laser	LT	1	1
Medium Laser	CT	1	1
Medium Laser	RT	1	1
LRM 5	RT	1	2
Ammo (LRM) 24	LT	1	1
Anti-Missile System	LA	1	.5
Ammo (Anti-Missile) 12	LT	1	1
CASE	LT	1	.5
Jump Jets	LL	2	1
Jump Jets	RL	2	1

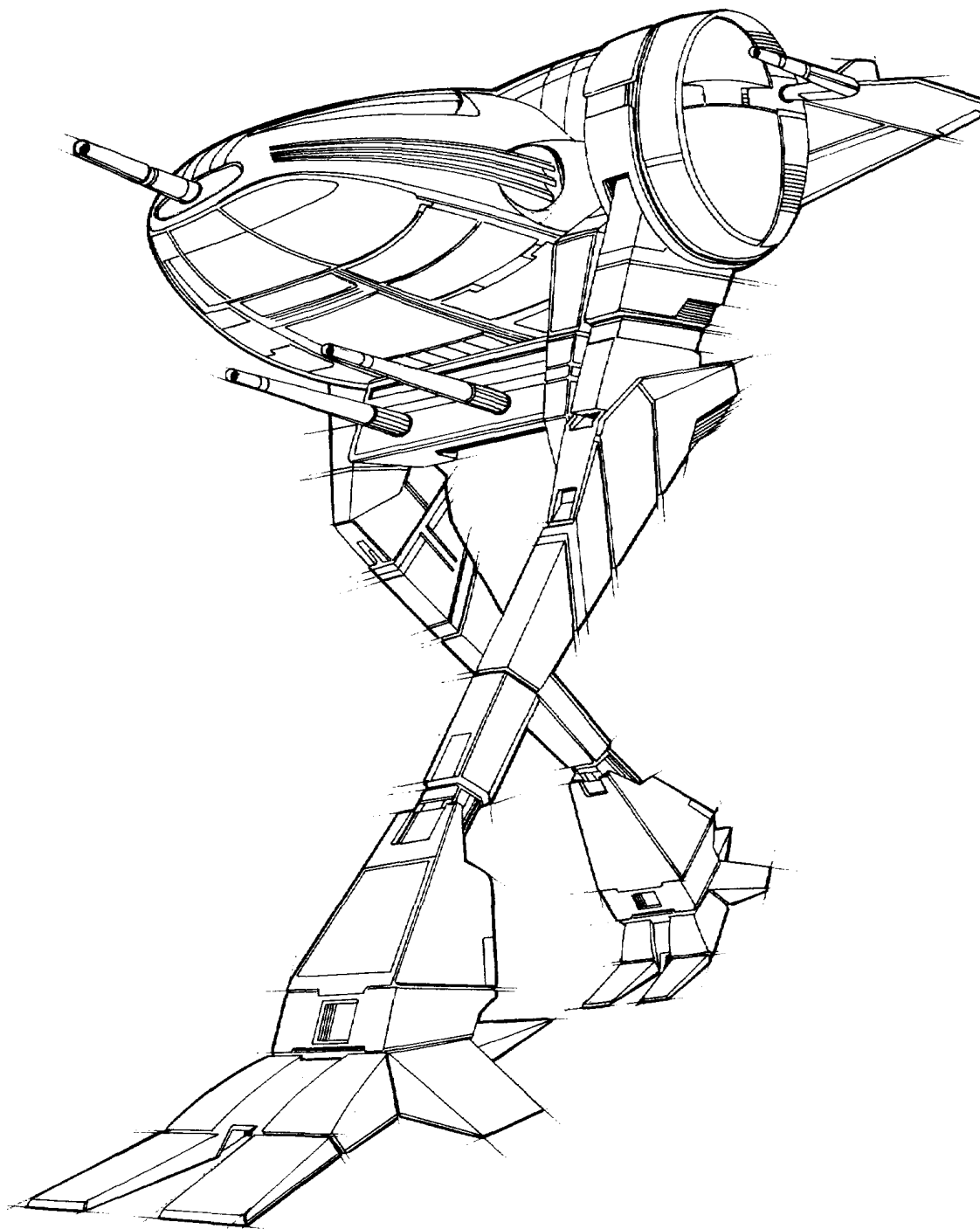



OVERVIEW

When Irian BattleMechs Unlimited shifted to production of the *Hermes II* in the late twenty-eighth century, the original *Hermes* became a dead design, existing only in blueprints. It was still a good light 'Mech design, but Irian no longer had the ability to equip it with an endo steel internal structure and ferro-fibrous armor. With the unlocking of many Star League-era technological secrets, the *Hermes* has once again become a feasible design.

Reliable agents inside Irian BattleMechs Unlimited report that the *Hermes* has begun limited production as a specialty 'Mech. Three separate models have come off the line, all dispensing with the flamer and incorporating Myomer Accelerator Signal Circuitry. All three are task-specific 'Mechs employing the MASC system as an emergency measure to get out of harm's way.

The most common of the three carries the Beagle active probe to enhance its reconnaissance capabilities. A single *Hermes* so equipped is commonly assigned to a battalion. The other two models are more likely to be assigned to a regimental headquarters unit. The first carries Guardian ECM equipment, usually to screen the position of the headquarters. The other carries target-acquisition gear to spot for 'Mechs and vehicles equipped with the artillery-range Arrow IV missile system. Few 'Mech units employ this weapon, and so the *Hermes* variant equipped with TAG is rare.

Mass: 30 tons
Chassis: Irian Chassis Class 10
Power Plant: GM 270
Cruising Speed: 97 kph
Maximum Speed: 151 kph, 194 kph w/ MASC
Jump Jets: None
Jump Capacity: None
Armor: Jolassa-328 Ferro-Fibrous
Armament:
 2 Hellion-V Medium Lasers
Manufacturer: Irian BattleMechs Unlimited
Primary Factory: Irian
Communications System: Irian Telestar
Targeting and Tracking System: Alexis Photon Target Acquisition System with Beagle Probe

Type: **Hermes**
 Technology Base: Inner Sphere
 Tonnage: 30

Equipment		Mass
Internal Structure:	Endo	1.5
Engine:	270	14.5
Walking MP:	9	
Running MP:	14 (18)	
Jumping MP:	0	
Heat Sinks:	10	0
Gyro:		3
Cockpit:		3
Armor Factor:	45	2.5
	<i>Internal Structure</i>	<i>Armor Value</i>
Head	3	5
Center Torso	10	6
Center Torso (rear)		2
R/L Torso	7	6
R/L Torso (rear)		2
R/L Arm	5	4
R/L Leg	7	4

Weapons and Ammo	Location	Critical	Tonnage
Medium Laser	RA	1	1
Medium Laser	LA	1	1
Beagle Active Probe	RT	2	1.5
MASC	LT	2	2

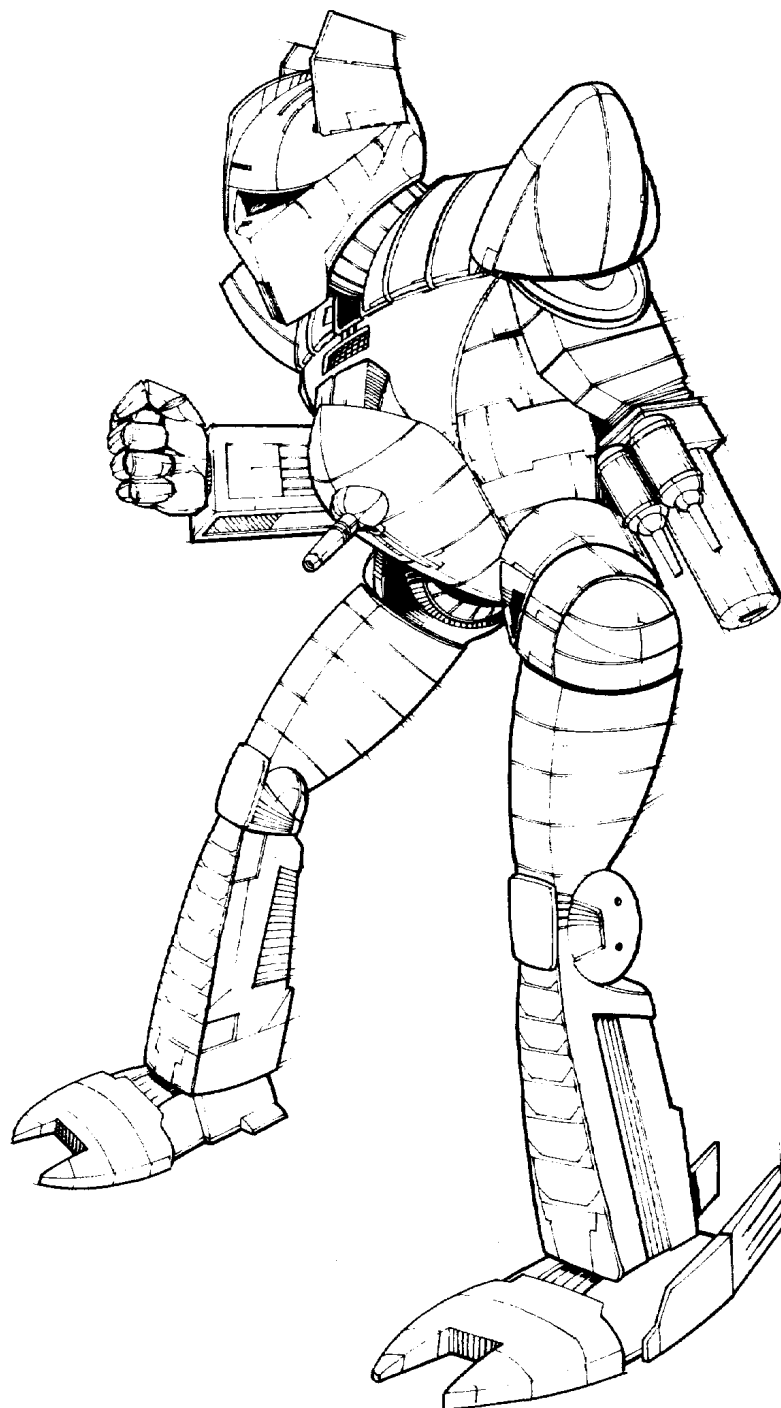

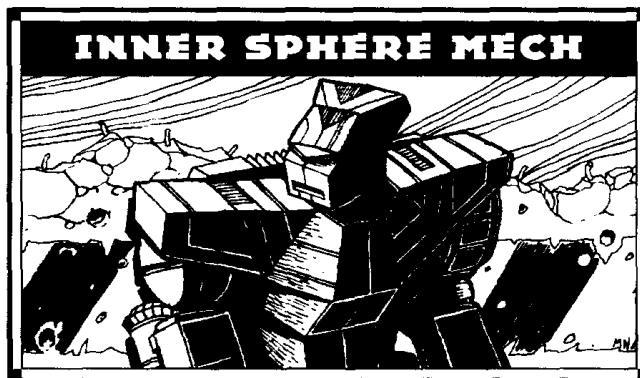

OVERVIEW

Originally designed in 2630 by the Star League Defense Forces to provide close support for infantry units, the *Hussar* quickly proved its worth as a reconnaissance scout. Its light, thirty-ton frame and 151-kph maximum speed give it greater maneuverability and enable it to handle a wider variety of terrain than many other scout 'Mechs.

The *Hussar* is equipped with a Newhart extended-range large laser, which gives it above-average range and targeting ability with far less maintenance than many other, similar weapons. Once within range of enemy weapons, however, the *Hussar* runs into trouble. If drawn into one-on-one combat, the *Hussar* can charge, kick or punch its way out—but with only 1.5 tons of ferro-fibrous armor, this BattleMech's best bet is to disengage and retreat.

The *Hussar*'s Ranger communications and targeting systems are above average, with extended-range capabilities for surveillance missions, and can jam most communications systems. Several well-placed *Hussars* behind enemy lines can completely disrupt the enemy's dissemination of orders and deployment of troops. Used as a reconnaissance scout, the *Hussar* can tap into transmissions between enemy BattleMechs as far as thirty-five kilometers away. The *Hussar* also has excellent transmission capability, allowing it to report on enemy movements and communications as well as jam them.

The SLDF also created a variant of the *Hussar* that mounts two Maxell medium lasers and doubles the 'Mech's armor, giving it much-needed protection in closer-range combat situations.

HSR 200-D HUSSAR

Mass: 30 tons
Chassis: Benztrov 40
Power Plant: GM 270
Cruising Speed: 97 kph
Maximum Speed: 151 kph
Jump Jets: None
Jump Capacity: None
Armor: Victory Anchor 2 Ferro-Fibrous
Armament:
 1 Newhart Extended Range Large Laser
Manufacturer: Newhart Industries
Communications System: Field Ranger Sightseer
Targeting and Tracking System: Ranger LAF Model 2

Type: Hussar
Technology Base: Inner Sphere
Tonnage: 30

Equipment		Mass
Internal Structure:		3
Engine:	270	14.5
Walking MP:	9	
Running MP:	14	
Jumping MP:	0	
Heat Sinks:	10 [20]	0
Gyro:		3
Cockpit:		3
Armor Factor:	27	1.5

	Internal Structure	Armor Value
Head	3	3
Center Torso	10	4
Center Torso (rear)		2
R/L Torso	7	3
R/L Torso (rear)		2
R/L Arm	5	2
R/L Leg	7	2

Weapons and Ammo	Location	Critical	Tonnage
ER Large Laser	CT	2	5

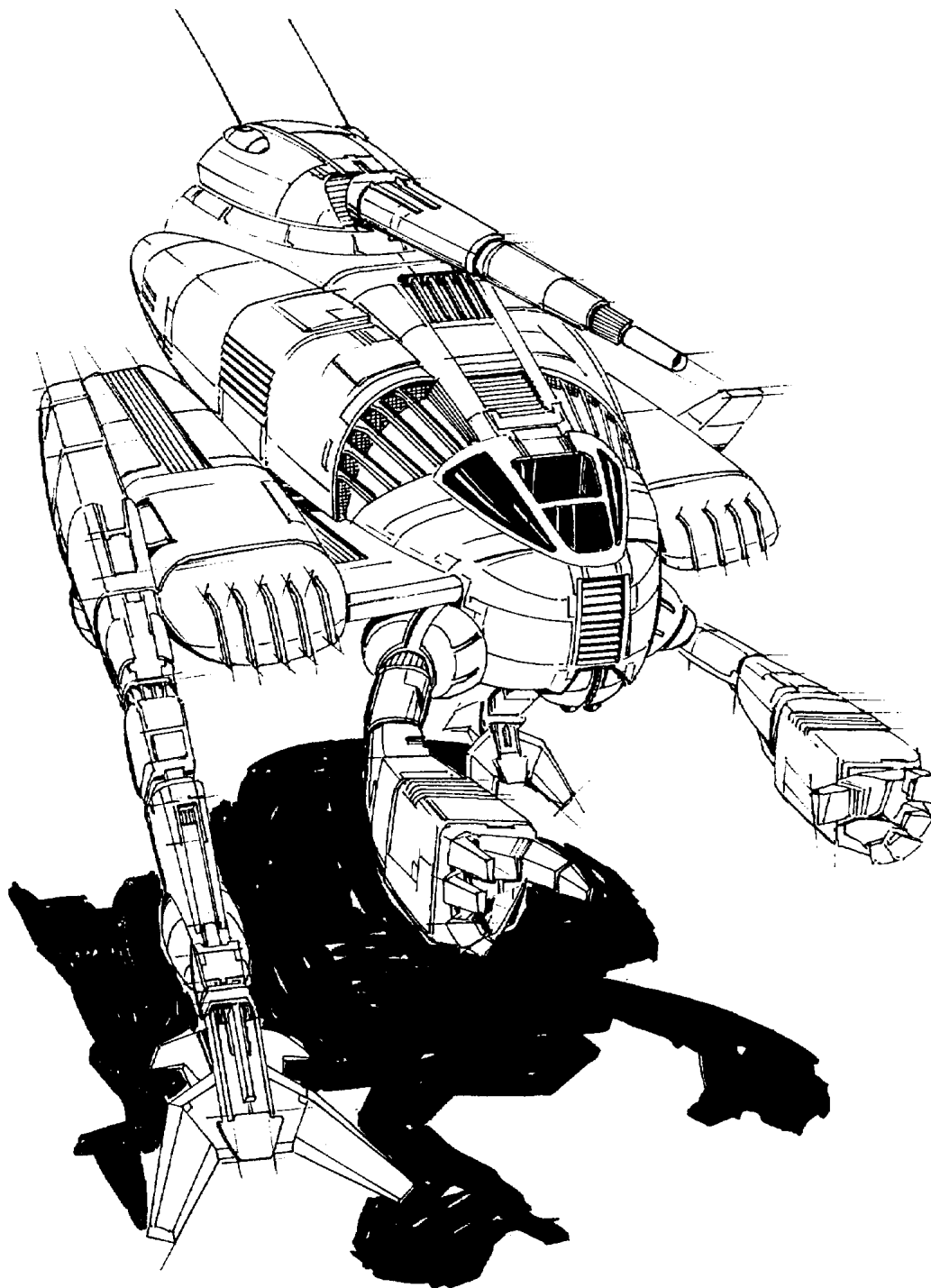



OVERVIEW

Several units of the AFFC employ the *Javelin*, but this 'Mech has been rare in other Inner Sphere armies since Stefan Amaris's Rim Worlds troops destroyed the Stormvanger Assemblies factory on Caph in 2774. Davion commanders have always held the *Javelin* in high regard, deploying it in much greater numbers than the other Successor States and preserving the 'Mech through the centuries of the Succession Wars.

With many *Javelins* still in service, Davion officers are expected to make field modifications to keep the 'Mechs abreast of recovered technology. ComStar has received reports of one variant, though the report has yet to be confirmed. The Federated Commonwealth is being unusually secretive about modifications to the *Javelin*.

According to the unconfirmed report, commanders are replacing the SRM-6 rack in the 'Mech's left torso with two SRM-2 launchers, presumably the Hovertec Streak. For a small sacrifice in firepower, this change would make the *Javelin* appreciably more efficient in using ammunition, enhancing its ability to stay on the battlefield. By keeping one of the SRM-6 racks, the *Javelin* variant may also make an enemy MechWarrior unsure of whether he is facing an original or a modified version of the 'Mech.

JVN-10P JAVELIN

Mass: 30 tons
Chassis: Duralyte 246
Power Plant: GM 180
Cruising Speed: 67.3 kph
Maximum Speed: 95.9 kph
Jump Jets: Rawlings 95
Jump Capacity: 180 meters
Armor: Star Guard I
Armament:
 1 Arrowlite SRM-6 Missile Rack
 2 Hovertec Streak SRM-2 Pods
Manufacturer: Stormvanger Assemblies, Light Division
Primary Factory: Caph
Communications System: Garret T10B
Targeting and Tracking System: Dynatec 128C

Type: **Javelin**
 Technology Base: Inner Sphere
 Tonnage: 30

Equipment		Mass
Internal Structure:		3
Engine:	180	7
Walking MP:	6	
Running MP:	9	
Jumping MP:	6	
Heat Sinks:	10	0
Gyro:		2
Cockpit:		3
Armor Factor:	64	4
	<i>Internal Structure</i>	<i>Armor Value</i>
Head	3	6
Center Torso	10	8
Center Torso (rear)		2
R/L Torso	7	8
R/L Torso (rear)		2
R/L Arm	5	6
R/L Leg	7	8

Weapons and Ammo	Location	Critical	Tonnage
SRM 6	RT	2	3
Ammo (SRM) 15	RT	1	1
Streak SRM 2	LT	1	1.5
Streak SRM 2	LT	1	1.5
Ammo (Streak) 50	LT	1	1
Jump Jets	CT	2	1
Jump Jets	LL	2	1
Jump Jets	RL	2	1

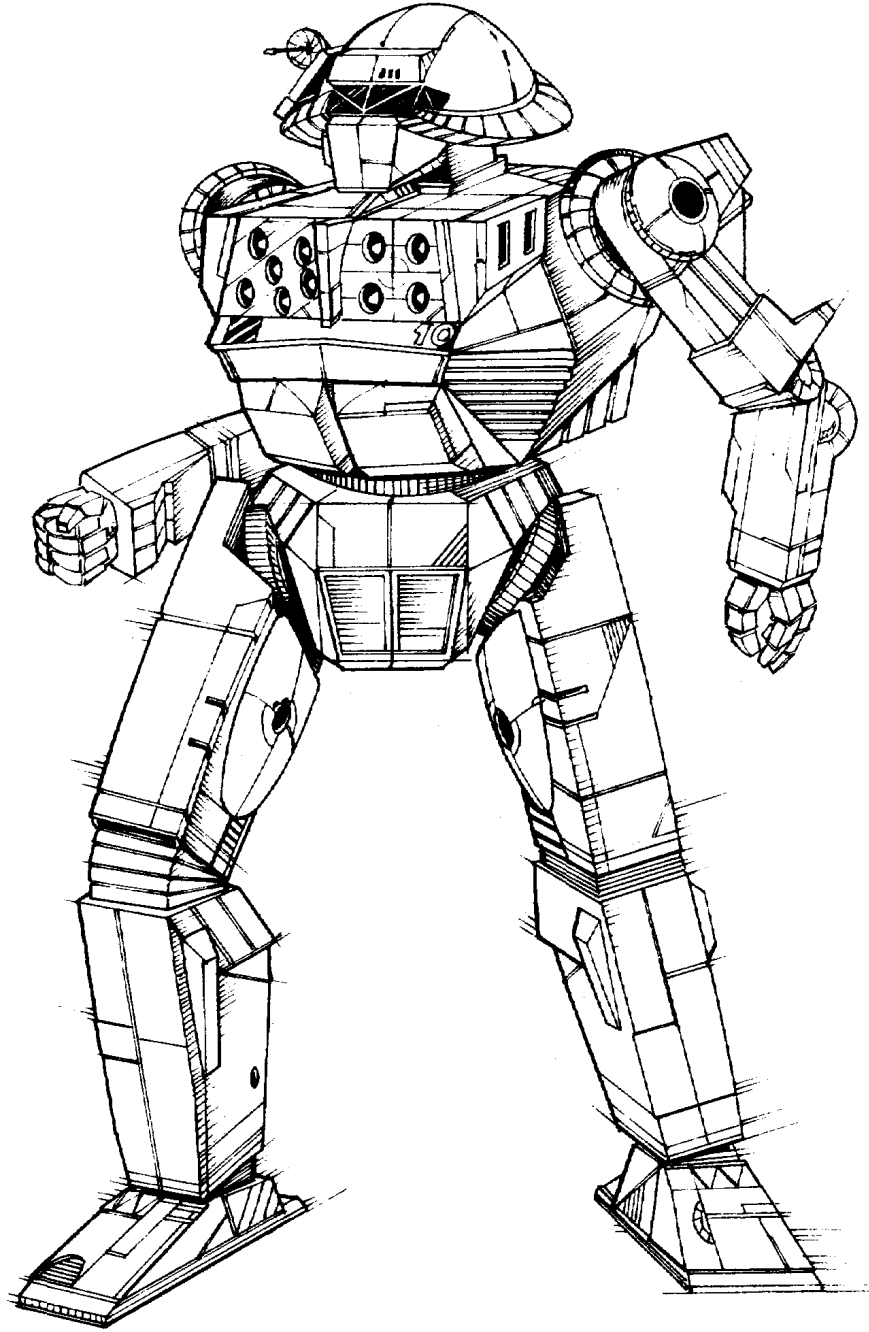

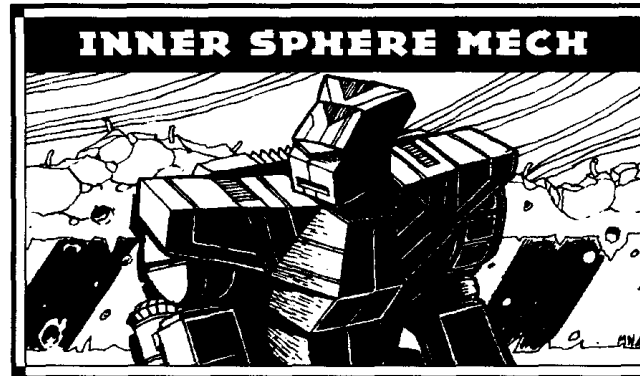

OVERVIEW

Nimakachi Fusion Products Ltd., the sole producer of the *Spider*, has recently announced plans to upgrade the 'Mech with recovered Star League-era technology. The Free Worlds League is the primary customer for Nimakachi's limited production of the *Spider*, but House Marik has indicated no intention of increasing the number of *Spiders* in its service. As it would be economic folly for the firm to retool its factories simply to produce sixteen or so 'Mechs per year, it is likely that one or more of the other Great Houses or mercenary units have placed orders with Nimakachi for the upgraded version.

The new SDR-7M *Spider* will incorporate an endo steel internal structure and ferro-fibrous armor to provide comparable protection at less weight. This change will allow Nimakachi to replace the original *Spider's* two medium lasers with new Tronel XII medium pulse lasers. For the price of slightly less armor protection, the new *Spider* will greatly improve its firepower.

With improved firepower added to its excellent speed and jumping ability, the SDR-7M *Spider* will have more uses and thus greater appeal to all of the Inner Sphere's armed forces. House Marik's good relations with House Kurita and the Draconis Combine's relative shortage of factories for light 'Mechs make it likely that Gunji no Kanrei Theodore Kurita is the motivating force behind the new design.

Mass: 30 tons
Chassis: Crucis-II Deluxe Endo Steel
Power Plant: Pitban 240
Cruising Speed: 86.4 kph
Maximum Speed: 130 kph
Jump Jets: Rawlings 75
Jump Capacity: 240 meters
Armor: Kallon FWL Special Ferro-Fibrous
Armament:
 2 Tronel XII Medium Pulse Lasers
Manufacturer: Nimakachi Fusion Products Ltd.
Primary Factory: Tematagi
Communications System: Omicron 4002 Networking Channel
Targeting and Tracking System: TRSS Eagle Eye

Type: **Spider**
 Technology Base: Inner Sphere
 Tonnage: 30

Equipment		Mass
Internal Structure:	Endo	1.5
Engine:	240	11.5
Walking MP:	8	
Running MP:	12	
Jumping MP:	8	
Heat Sinks:	10	0
Gyro:		3
Cockpit:		3
Armor Factor:	54	3
	<i>Internal Structure</i>	<i>Armor Value</i>
Head	3	6
Center Torso	10	8
Center Torso (rear)		4
R/L Torso	7	6
R/L Torso (rear)		2
R/L Arm	5	5
R/L Leg	7	5

Weapons and Ammo	Location	Critical	Tonnage
Medium Pulse Laser	CT	1	2
Medium Pulse Laser	CT	1	2
Jump Jets	RT	4	2
Jump Jets	LT	4	2

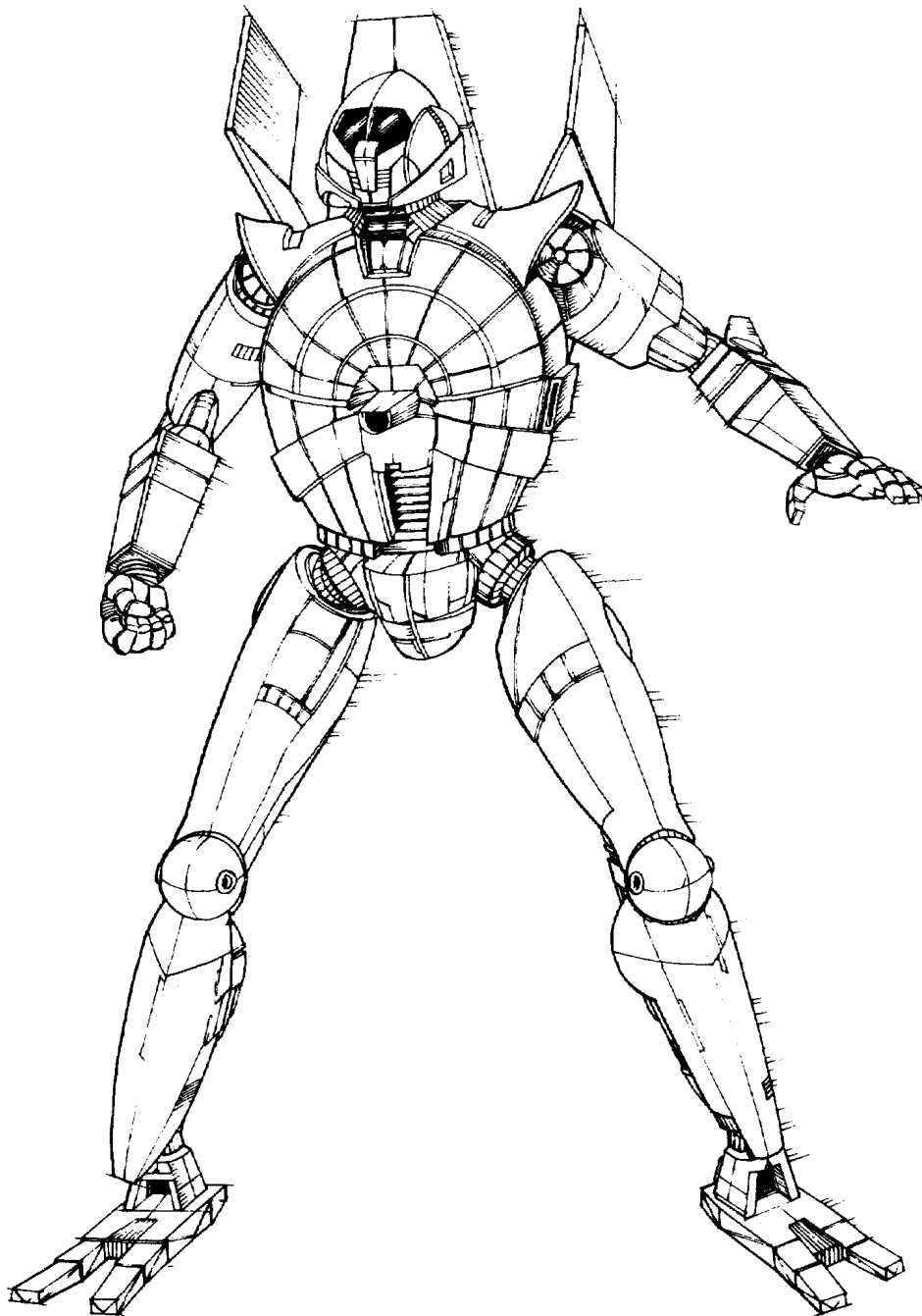

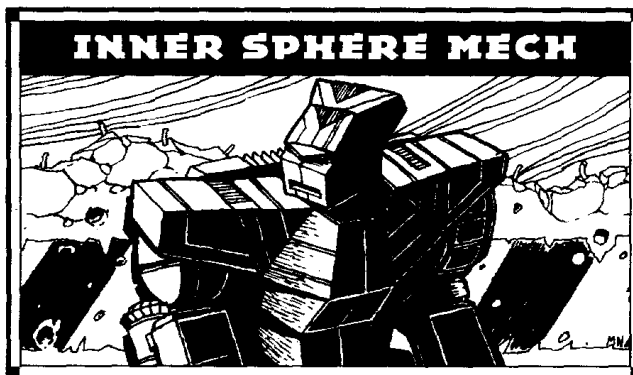

OVERVIEW

Though generally disdained and consigned to garrison duty, the *UrbanMech* exists in numbers too large for the design to be abandoned. The Capellan Confederation especially would find its army seriously weakened if it allowed its *UrbanMechs* to be further outclassed by the advancing technology of its neighbors' armed forces. Though the Capellans field the highest percentage of *UrbanMechs*, the design is common throughout the Inner Sphere.

Different modifications are being tried in different realms, but none have resolved the *UrbanMech's* biggest deficiency—its lack of speed. Though the technology to add an extra-light engine is generally available, the extra room such an engine requires makes a field refit impossible. Consequently, field modifications to the *UrbanMech* confine themselves to tinkering with the weapons systems.

The official Capellan field modification kit seems to offer the most advantages. Replacing the Emperor-B autocannon with the Mydron Excel LB 10-X enhances the 'Mech's firing range and accuracy, in addition to reducing its weight enough to allow other enhancements. This kit also substitutes the Magna 200P small pulse laser for the machine gun, which helps discourage enemy infantry. Both these changes give the *UrbanMech* greater advantages in city fighting.

Mass: 30 tons
Chassis: Republic-R
Power Plant: Leenex 60
Cruising Speed: 21.6 kph
Maximum Speed: 32.4 kph
Jump Jets: Pitban 6000
Jump Capacity: 60 meters

Armor: Durallex Medium

Armament:
 1 Mydron Excel LB 10-X Autocannon
 1 Magna 200P Small Pulse Laser
 1 Harmon Small Laser

Manufacturer: Orguss Industries

Primary Factory: Marcus

Communications System: Dalban Interact

Targeting and Tracking System: Dalban Urban

Type: **UrbanMech**

Technology Base: Inner Sphere

Tonnage: 30

Equipment		Mass
Internal Structure:		3
Engine:	60	1.5
Walking MP:	2	
Running MP:	3	
Jumping MP:	2	
Heat Sinks:	11	1
Gyro:		1
Cockpit:		3
Armor Factor:	96	6

	Internal Structure	Armor Value
Head	3	9
Center Torso	10	11
Center Torso (rear)		8
R/L Torso	7	8
R/L Torso (rear)		4
R/L Arm	5	10
R/L Leg	7	12

Weapons and Ammo	Location	Critical	Tonnage
LB 10-X AC	RA	6	11
Ammo (LB-X) 10	RT	1	1
Small Pulse Laser	LT	1	1
Small Laser	LA	1	.5
Jump Jets	CT	2	1

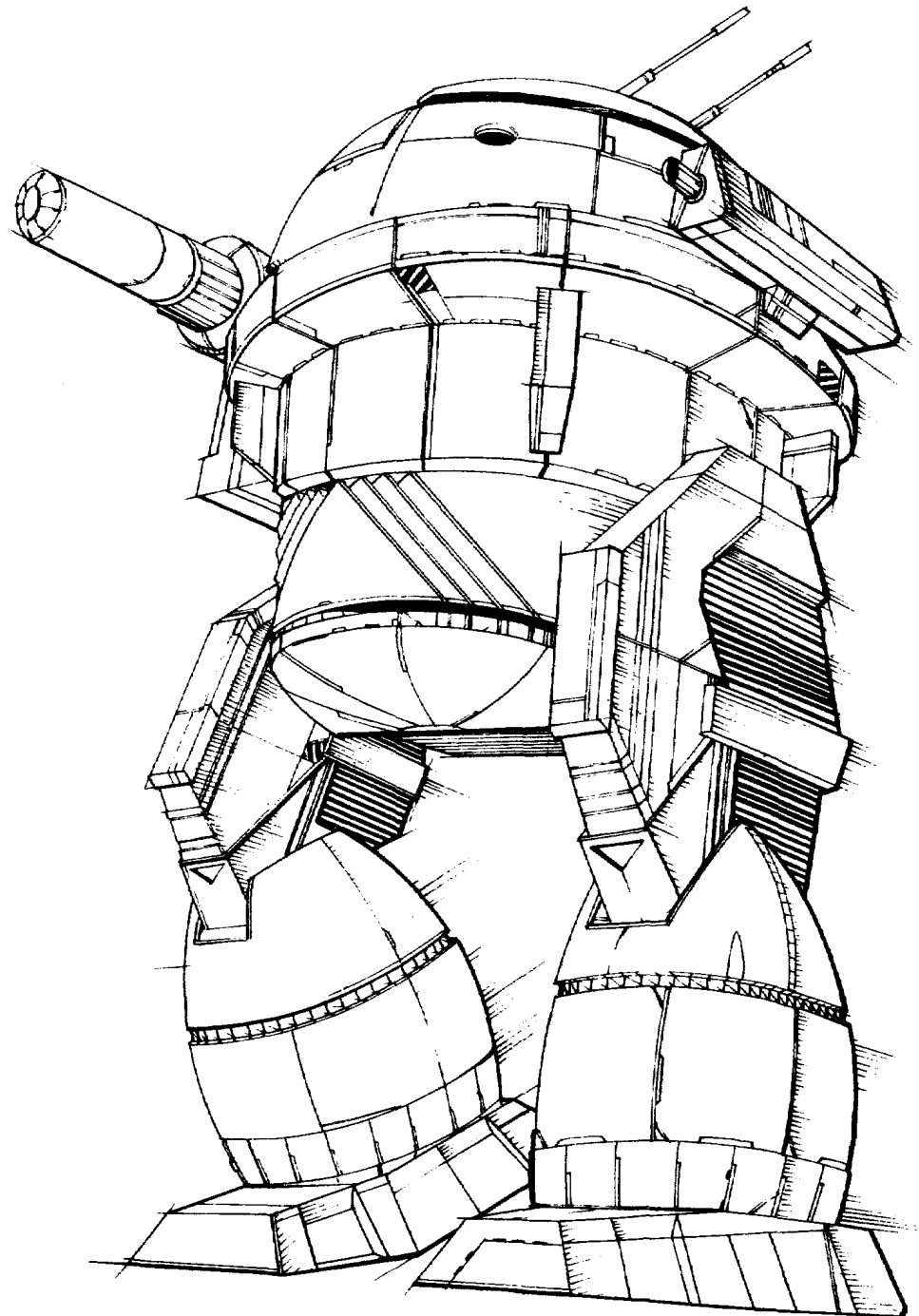



OVERVIEW

A specialty 'Mech not designed for front-line service, the *Firestarter* might have seemed a low-priority candidate to receive recovered Star League-era technology. Inner Sphere military analysts were surprised when Federated Commonwealth military planners ordered trials for the prototype FS9-S *Firestarter* on Tharkad in 3049.

Coventry Metal Works, which has been producing a few *Firestarters* each year for decades, equipped the 'Mech with endo steel, lightening its internal structure enough to add other weapons and equipment. They replaced both machine guns with a SureFire 444 anti-missile system for added defense, but the major change they made was to its electronics array.

The *Firestarter's* normal deployment of one to each battalion headquarters or regimental headquarters made it an excellent candidate to carry specialized electronic gear. The *Firestarter* that strutted its stuff at Tharkad in 3049 carried the sophisticated Cyclops Beagle probe for locating concealed enemy positions. Given the advantages of such an equipment change, it is likely that other *Firestarters* will also be equipped with either the Beagle active probe or Guardian electronic countermeasures equipment.

Mass: 35 tons
Chassis: Foundation Ultralight Endo Steel
Power Plant: GM 210
Cruising Speed: 64.8 kph
Maximum Speed: 97.2 kph
Jump Jets: Luxor Load Lifters
Jump Capacity: 180 meters
Armor: Durallex Nova
Armament:
 4 Hotshot Flamers
 2 Defiance B3M Medium Lasers
 1 Diverse Optics Type 10 Small Laser
 1 SureFire 444 Anti-Missile System
Manufacturer: Coventry Metal Works
Primary Factory: Coventry
Communications System: Cyclops 14
Targeting and Tracking System: Cyclops-Beagle
 Sensory Probe

Type: **Firestarter**
 Technology Base: Inner Sphere
 Tonnage: 35

Equipment		Mass
Internal Structure:	Endo	2
Engine:	210	9
Walking MP:	6	
Running MP:	9	
Jumping MP:	6	
Heat Sinks:	10	0
Gyro:		3
Cockpit:		3
Armor Factor:	88	5.5
	<i>Internal Structure</i>	<i>Armor Value</i>
Head	3	9
Center Torso	11	13
Center Torso (rear)		6
R/L Torso	8	10
R/L Torso (rear)		6
R/L Arm	6	7
R/L Leg	8	7

Weapons and Ammo	Location	Critical	Tonnage
Flamer	RA	1	1
Flamer	CT	1	1
Flamer	CT (R)	1	1
Flamer	LA	1	1
Medium Laser	LA	1	1
Medium Laser	RA	1	1
Small Laser	RT	1	.5
Anti-Missile System	LT	1	.5
Ammo (Anti-Missile) 12	LT	1	1
Beagle Active Probe	LT	2	1.5
Jump Jets	RT	3	1.5
Jump Jets	LT	3	1.5

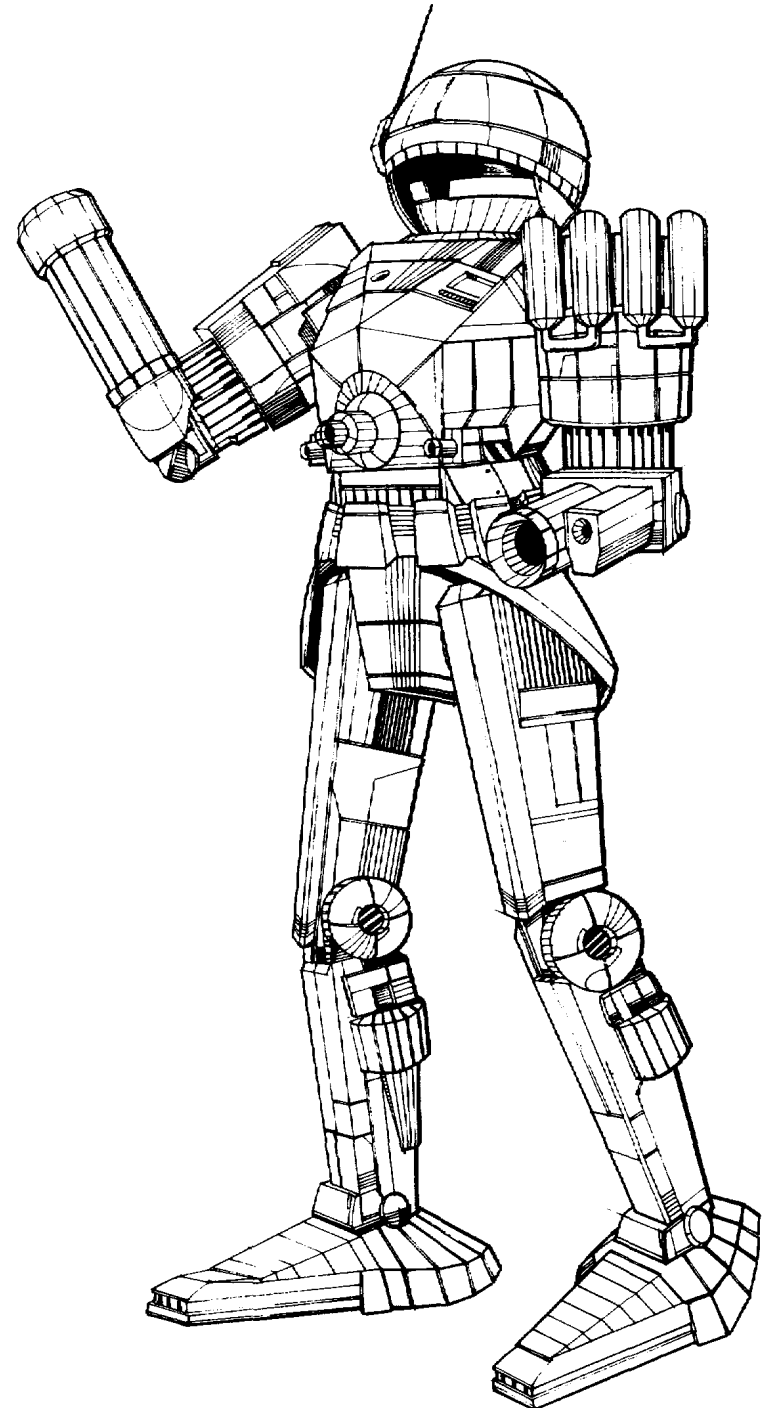



OVERVIEW

Along with the *Panther*, the *Jenner* has long been a favored front-line light 'Mech in the Draconis Combine Mustered Soldiery and has proven useful in many roles. It can defeat most other light 'Mechs in a one-on-one battle, and it is fast and maneuverable enough to perform the scouting and screening duties traditionally assigned to a light 'Mech.

During the War of 3039, several incidents provided a reason to change the *Jenner's* design. At least six times during that war, a lightly damaged *Jenner* blew itself to pieces when the missile reloads detonated from a freak enemy shot. The availability of Star League-era technology has provided a solution to this problem.

Employing lighter New Samarkand Royal ferro-fibrous armor to achieve almost the same degree of protection with half a ton less weight, engineers at Luthien Armor Works fitted the *Jenner's* right torso with Cellular Ammunition Storage Equipment to mitigate the effects of an ammunition explosion. Though this model has only just begun to see service, it appears that Kurita military planners have enhanced an excellent design with little loss of production capability.

Mass: 35 tons
Chassis: Alshain Class 48
Power Plant: Magna 245
Cruising Speed: 75.6 kph
Maximum Speed: 118.8 kph
Jump Jets: Lexington Ltd. Lifters
Jump Capacity: 150 meters
Armor: New Samarkand Royal Ferro-Fibrous with CASE
Armament:
 1 Telos SRM-4 Missile Rack
 4 Victory 23R Medium Lasers
Manufacturer: Luthien Armor Works
Primary Factory: Luthien
Communications System: Sipher Security Plus
Targeting and Tracking System: Matabushi Sentinel

Type: **Jenner**
 Technology Base: Inner Sphere
 Tonnage: 35

Equipment		Mass
Internal Structure:		3.5
Engine:	245	12
Walking MP:	7	
Running MP:	11	
Jumping MP:	5	
Heat Sinks:	10	0
Gyro:		3
Cockpit:		3
Armor Factor:	63	3.5
	<i>Internal Structure</i>	<i>Armor Value</i>
Head	3	7
Center Torso	11	9
Center Torso (rear)		3
R/L Torso	8	8
R/L Torso (rear)		4
R/L Arm	6	4
R/L Leg	8	6

Weapons and Ammo	Location	Critical	Tonnage
SRM 4	CT	1	2
Ammo (SRM) 25	RT	1	1
CASE	RT	1	.5
Medium Laser	RA	1	1
Medium Laser	RA	1	1
Medium Laser	LA	1	1
Medium Laser	LA	1	1
Jump Jets	RT	2	1
Jump Jets	LT	2	1
Jump Jet	CT	1	.5

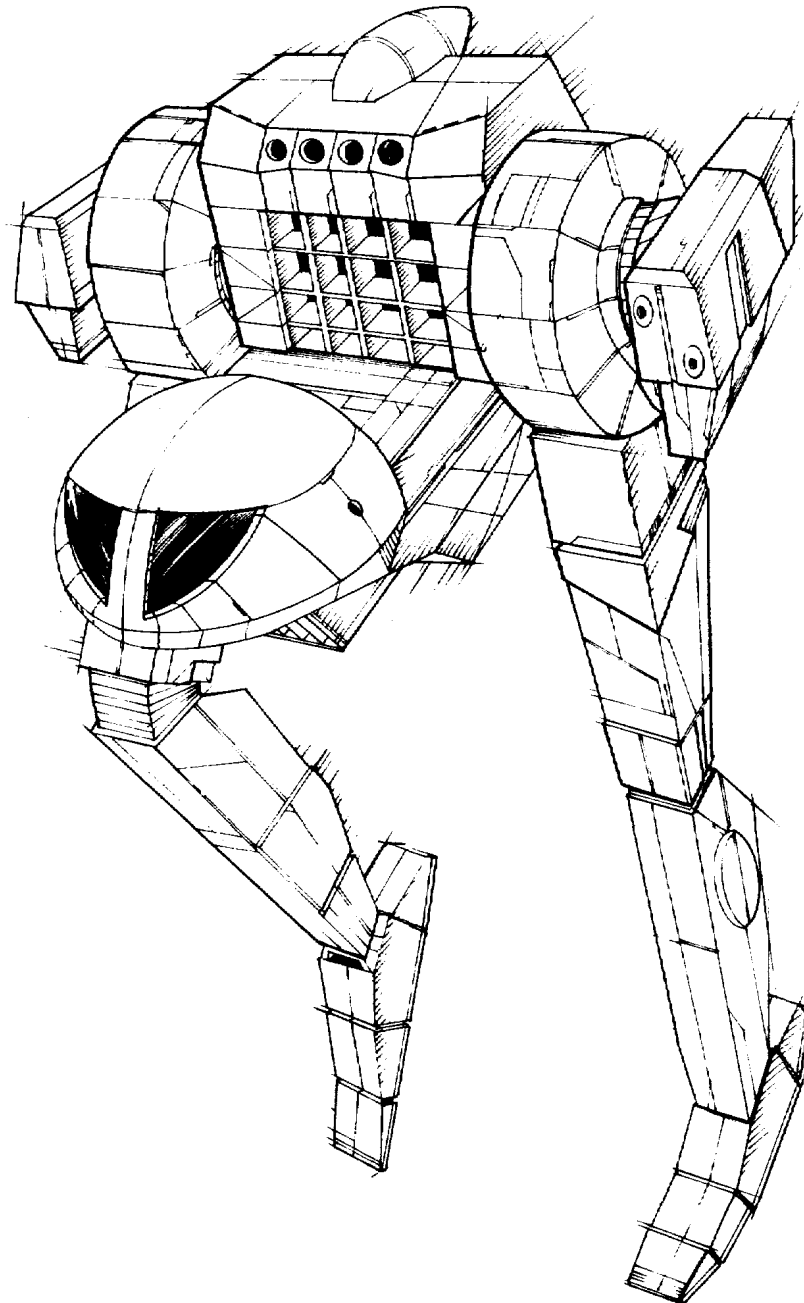



OVERVIEW

Produced only by Alshain Weapons and its parent company—Gorton, Kingsley and Thorpe Enterprises—the *Panther* has been House Kurita's pre-eminent light 'Mech throughout the Succession Wars. With the New Oslo factory located inside the Free Rasalhague Republic, the *Panther* also played an important part in the development of the Republic's KungsArmé, especially the Husar regiments.

Ten years ago, the *Panther* was produced on the planets of New Oslo and Jarett, both of which have fallen to the Clans in the past year. The New Oslo plant was disassembled and the Jarett plant gutted before the Clans took either planet, and the production of *Panthers* has dropped dramatically.

Prior to the Clan invasion, Alshain Weapons had plans in the works to build another factory on Krenice. The Clans' arrival forced Alshain to step up those plans, and *Panthers* incorporating recovered technology are expected to begin marching off the line at Krenice sometime within the next year.

The availability of Star League technology has given Gorton, Kingsley and Thorpe the chance to make a good thing better at its rebuilt factory on Satalice. Though the *Panther* was already well-armed and -armored, GK&T is planning to improve both of the 'Mech's weapon systems and to beef up its defenses. The use of endo steel in the new *Panther's* internal structure saves enough weight to allow for other changes.

The excellent Lord's Light PPC is replaced in the new *Panther* by the second-generation, extended-range Lord's Light 2. Field trials have shown no problems with the new system. The reliable Cat's Eyes 5 targeting system has been merged with the Artemis IV fire-control system, greatly improving the accuracy of the Telos-4 SRM launcher. Though the *Panther* is well-armored for a light 'Mech, an occasional lucky shot has detonated missile reloads in the past, making the revamped *Panther* a perfect candidate for Cellular Ammunition Storage Equipment. *Panthers* with such equipment are just beginning to reach the most prestigious units.

PNT-1 OK PANTHER

Mass: 35 tons
Chassis: Alshain 560-Carrier Endo Steel
Power Plant: Leenex 140
Cruising Speed: 43.2 kph
Maximum Speed: 64.8 kph
Jump Jets: Lexington Ltd. Lifters
Jump Capacity: 120 meters
Armor: Maximilian 42
Armament:
 1 Telos SRM-4 Missile Rack
 1 Lord's Light 2 Extended Range PPC
Manufacturer: Alshain Weapons, Gorton, Kingsley and Thorpe Enterprises
Primary Factory: Krenice (Alshain), Satalice (GK&T)
Communications System: Sipher CommCon SCU-4
Targeting and Tracking System: Cat's Eyes 5 with Artemis IV System

Type: **Panther**
 Technology Base: Inner Sphere
 Tonnage: 35

Equipment		Mass
Internal Structure:	Endo	2
Engine:	140	5
Walking MP:	4	
Running MP:	6	
Jumping MP:	4	
Heat Sinks:	13	3
Gyro:		2
Cockpit:		3
Armor Factor:	104	6.5
	<i>Internal Structure</i>	<i>Armor Value</i>
Head	3	9
Center Torso	11	14
Center Torso (rear)		7
R/L Torso	8	10
R/L Torso (rear)		5
R/L Arm	6	10
R/L Leg	8	12

Weapons and Ammo	Location	Critical	Tonnage
SRM 4	CT	1	2
Ammo (SRM) 25	LT	1	1
Artemis IV FCS	CT	1	1
CASE	LT	1	.5
ER PPC	RA	3	7
Jump Jets	RL	2	1
Jump Jets	LL	2	1

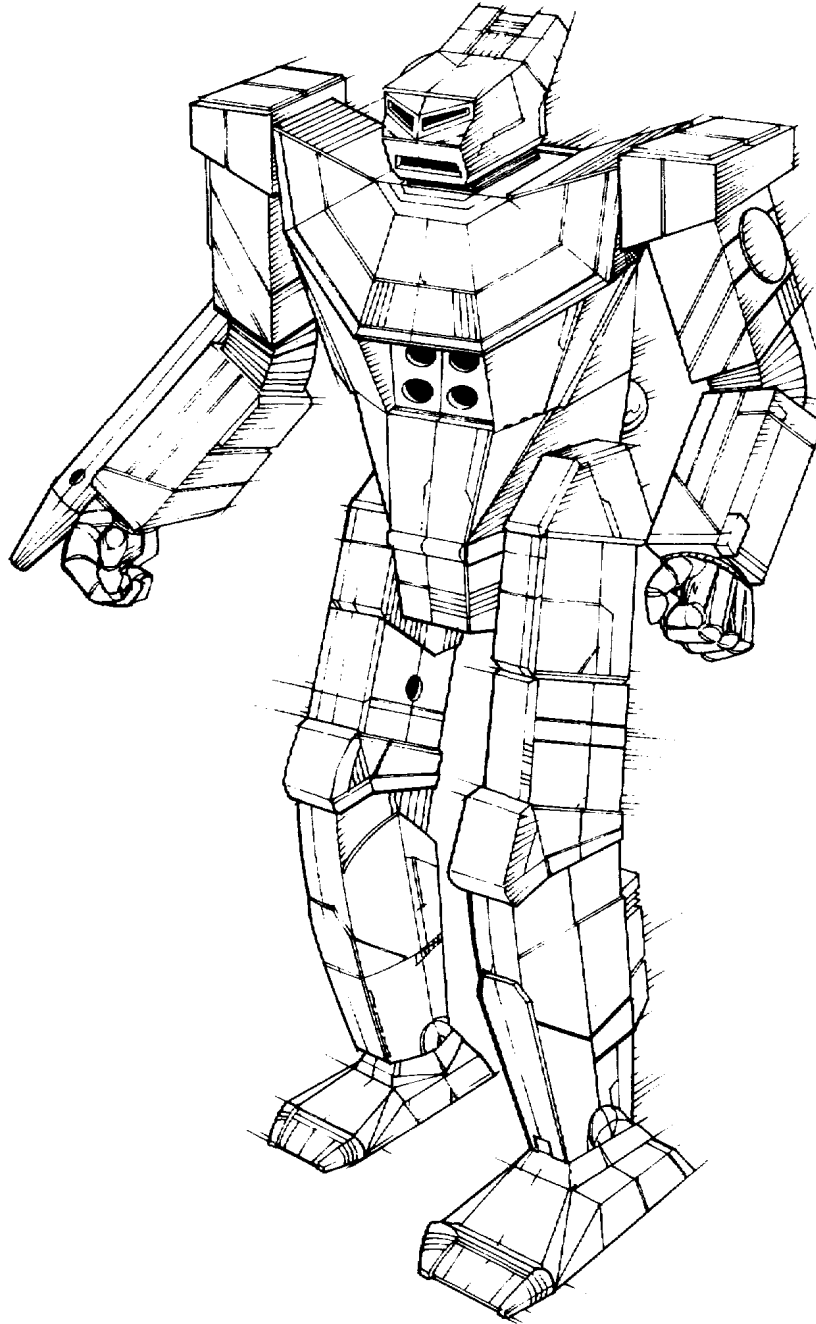



OVERVIEW

Two decades ago, the *Raven* was House Liao's experimental attempt to produce a 'Mech that could provide a battalion or regiment with sophisticated electronic-warfare capabilities. The equipment was not a complete success, being too heavy and insufficiently sophisticated to turn the tide of battle. Recovered Star League technology, however, has made the *Raven* a viable BattleMech. Produced exclusively by Hellespont Industries on Sian, the RVN-3L *Raven* is striding off the assembly line bristling with the most advanced electronics ever seen in the Inner Sphere.

The key to the 'Mech's success are the lighter materials and equipment now available. The Hermes 210 XL engine saved enough mass to equip the *Raven* with even more electronic gear than its original designers planned in 3025. The Guardian ECM suite helps shield the *Raven* and the rest of its accompanying unit from enemy sensors. The Beagle probe, which meshes especially well with the Apple Churchill 2000 targeting system, locates even hidden enemy units. Once it locates the enemy, the *Raven* can bombard him to rubble. The target-acquisition gear, hooked directly to the Beagle probe, spots the enemy accurately for friendly fire from the Arrow IV artillery system. The Churchill Narc Beacon also provides a magnet for direct-fire missiles from the *Raven* and the rest of the 'Mechs in its unit.

The economy of weight allows Hellespont Industries to give the *Raven* better armor protection as well. An additional half-ton of armor protects the front torso and arms, and Cellular Ammunition Storage Equipment shields the missile reloads against an internal explosion.

Mass: 35 tons
Chassis: Hellespont Type R
Power Plant: GM 210 XL
Cruising Speed: 64.8 kph
Maximum Speed: 97 kph
Jump Jets: None
Jump Capacity: None

Armor: Hellespont Lite Ferro-Fibrous with CASE

Armament:
 1 Harpoon SRM-6 Missile Rack
 2 Ceres Arms Medium Lasers
 1 Apple Churchill Guiding Light Narc Beacon

Manufacturer: Hellespont Industries

Primary Factory: Sian

Communications System: Ceres Metals Model 666 with Guardian Electronic Countermeasures

Targeting and Tracking System: Apple Churchill 2000 with Beagle Probe and 442x Target Acquisition Gear

Type: **Raven**
 Technology Base: Inner Sphere
 Tonnage: 35

Equipment		Mass
Internal Structure:		3.5
Engine:	210 XL	4.5
Walking MP:	6	
Running MP:	9	
Jumping MP:	0	

Heat Sinks:	11	1
Gyro:		3
Cockpit:		3
Armor Factor:	81	4.5

	Internal Structure	Armor Value
Head	3	6
Center Torso	11	11
Center Torso (rear)		4
R/L Torso	8	11
R/L Torso (rear)		3
R/L Arm	6	8
R/L Leg	8	8

Weapons and Ammo	Location	Critical	Tonnage
SRM 6	RT	2	3
Ammo (SRM) 15	LT	1	1
CASE	LT	1	.5
Medium Laser	RA	1	1
Medium Laser	RA	1	1
Beagle Active Probe	CT	2	1.5
Guardian ECM Suite	LT	2	1.5
Narc Missile Beacon	LA	2	3
Ammo (Narc) 12	LT	2	2
TAG	RT	1	1

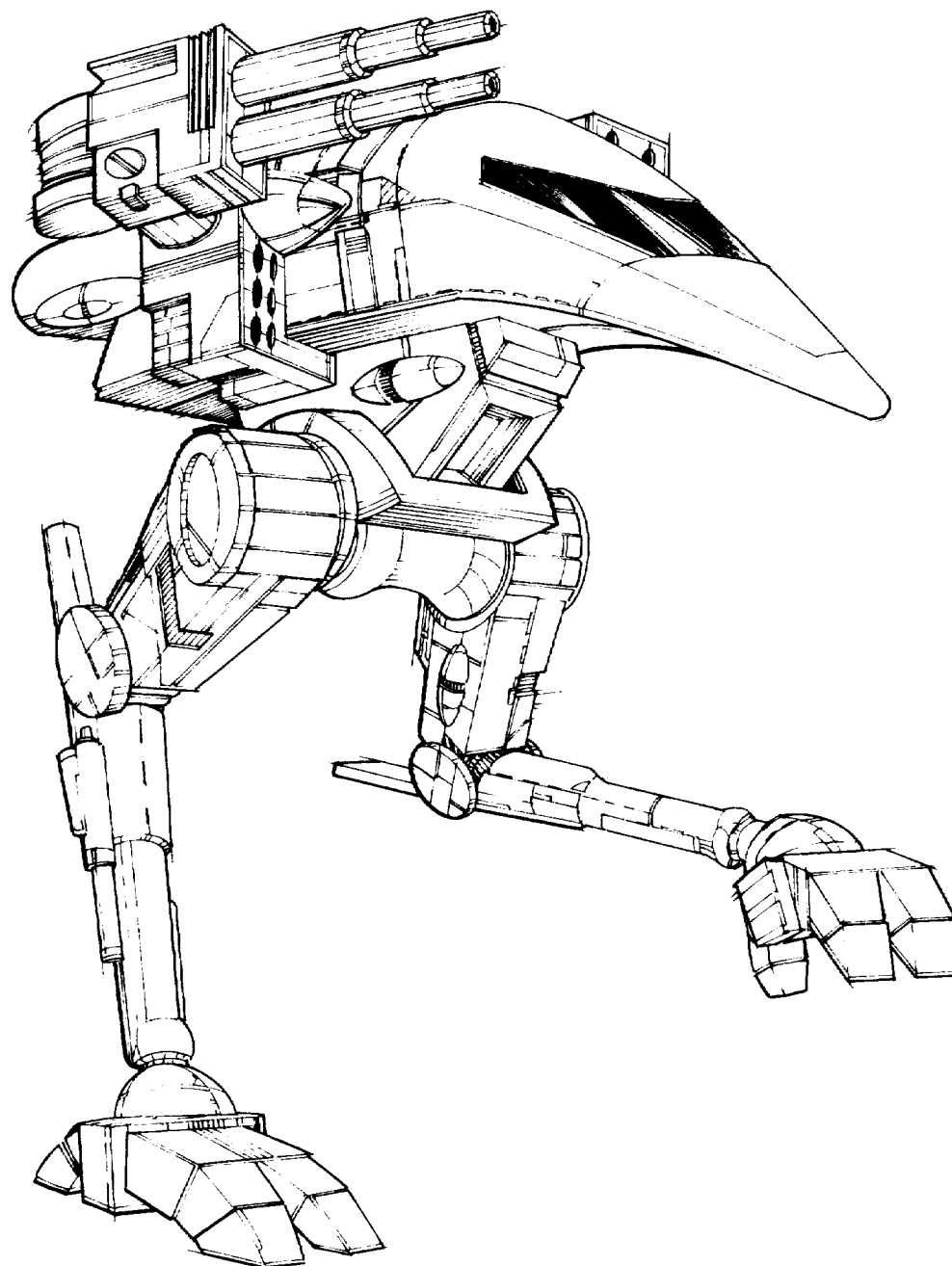

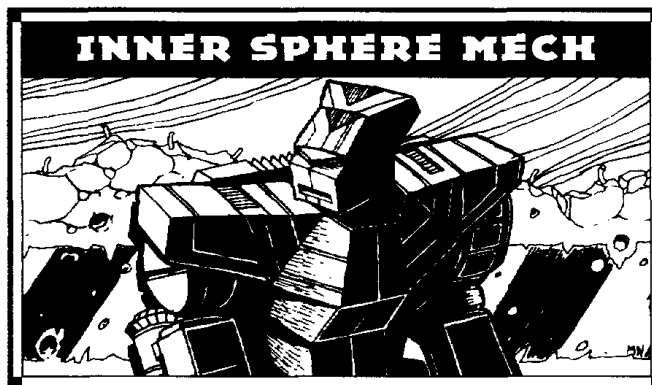

OVERVIEW

Both the Kell Hounds and Wolf's Dragoons have had great success with the *Wolfhound*. Though produced by one of the most respected BattleMech factories in Steiner space, this design was not approved for use by Lyran or Davion units until after the Fourth Succession War, leading some observers to wonder if the two mercenary units were doing field tests for Archon Katrina Steiner. If the Fourth Succession War was a test for the *Wolfhound*, it passed with flying colors, defeating Kurita *Panthers* on numerous occasions.

The Federated Commonwealth has since ordered major increases in production. The Tharkad factory has, however, slowed its pace in the last six months to allow retooling in order to fit the *Wolfhound* with recovered technology. Though the 'Mech retains the Defiance B3M medium lasers, a Cyclops XII extended-range large laser replaces the Setanta heavy laser.

Perhaps the most significant change in the new WLF-2 model is the use of double heat sinks. Though most light 'Mechs have little problem with heat, the *Wolfhound's* reliance on laser weapons made it more vulnerable to heat build-up than most. Star League-era double heat sinks provided the solution, and the *Wolfhound* is the lightest 'Mech to employ them.

WLF-2 WOLFHOUND

Mass: 35 tons
Chassis: Arc-Royal KH/3
Power Plant: GM 210
Cruising Speed: 64 kph
Maximum Speed: 95 kph
Jump Jets: None
Jump Capacity: None
Armor: Durallex Medium
Armament:
1 Cyclops XII Extended Range Large Laser
4 Defiance B3M Medium Lasers
Manufacturer: TharHes Industries
Primary Factory: Tharkad
Communications System: O/P COM-22/H47
Targeting and Tracking System: Digital Scanlok 347

Type: **Wolfhound**
Technology Base: Inner Sphere
Tonnage: 35

Equipment		Mass
Internal Structure:		3.5
Engine:	210	9
Walking MP:	6	
Running MP:	9	
Jumping MP:	0	
Heat Sinks:	10 [20]	0
Gyro:		3
Cockpit:		3
Armor Factor:	120	7.5
	<i>Internal Structure</i>	<i>Armor Value</i>
Head	3	9
Center Torso	11	16
Center Torso (rear)		6
R/L Torso	8	11
R/L Torso (rear)		5
R/L Arm	6	12
R/L Leg	8	16

Weapons and Ammo	Location	Critical	Tonnage
ER Large Laser	RA	2	5
Medium Laser	CT	1	1
Medium Laser	RT	1	1
Medium Laser	LT	1	1
Medium Laser	CT (R)	1	1

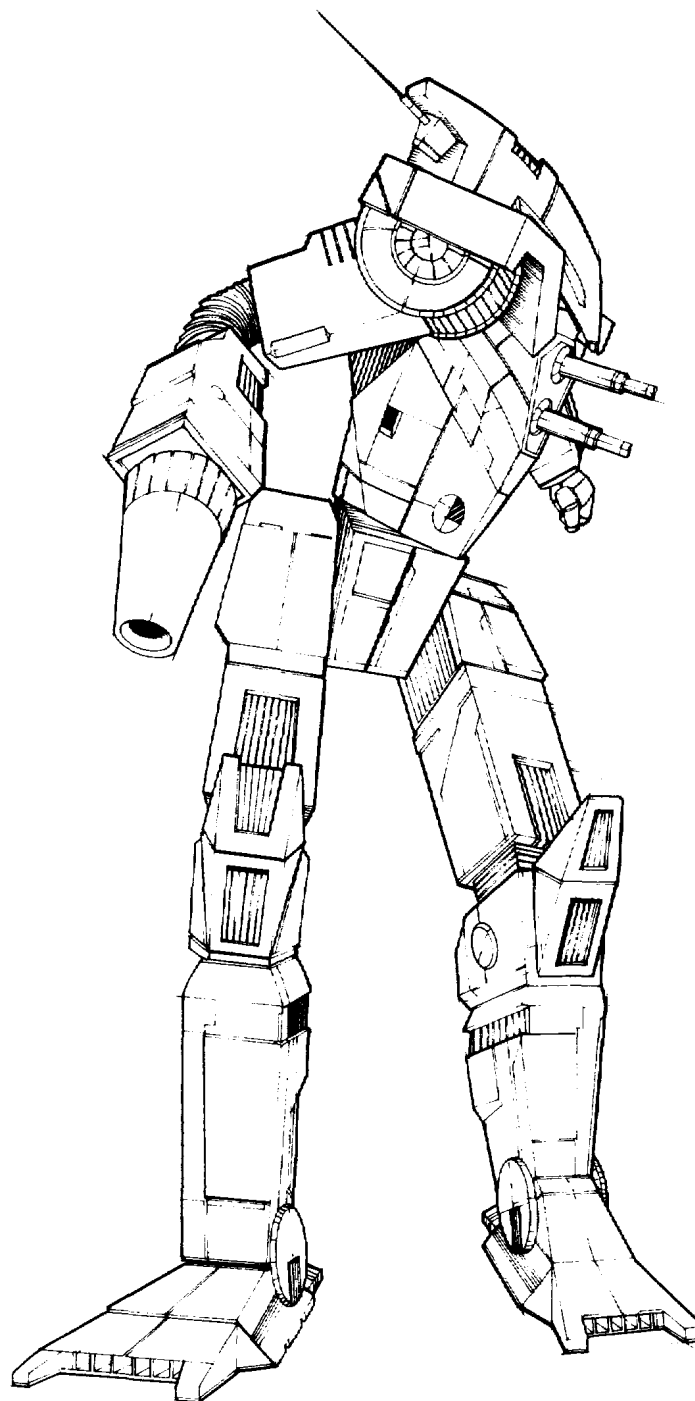



OVERVIEW

Never produced in great numbers, the *Assassin* has become even more scarce since the Fourth Succession War. Centuries of wear and tear on Inner Sphere battlefields have not helped the 'Mech's performance. Though the *Assassin* has some design advantages, the MechWarriors who pilot it are often overly cautious because of the lack of spare parts.

The Holly short-range missile rack has also been problematic. The loading mechanism has a tendency to jam, and this problem has worsened with age. Rather than write off the *Assassin* entirely, however, many units are using rediscovered Star League-era technology to give the 'Mech a slightly different role. In many units the balky SRM rack is removed, creating room for other weapons or equipment. A common modification upgrades the medium laser to a pulse laser, normally the readily available Magna 400P. In addition, these 'Mechs mount the Artemis IV fire-control system to enhance the value of the Holly long-range missiles. So configured, the *Assassin* is once again an asset on some missions.

ASN-23 ASSASSIN

Mass: 40 tons
Chassis: Maltex 40
Power Plant: VOX 280
Cruising Speed: 75.6 kph
Maximum Speed: 118.8 kph
Jump Jets: 100AFVTA
Jump Capacity: 210 meters
Armor: Lox lift series 1
Armament:
1 Magna 400P Medium Pulse Laser
1 Holly LRM-5 Missile Rack
Manufacturer: Maltex Corporation
Primary Factory: Errai
Communications System: Garret T15 B
Targeting and Tracking System: Garret 500S with Artemis IV System

Type: **Assassin**
Technology Base: Inner Sphere
Tonnage: 40

Equipment		Mass
Internal Structure:		4
Engine:	280	16
Walking MP:	7	
Running MP:	11	
Jumping MP:	7	
Heat Sinks:	10	0
Gyro:		3
Cockpit:		3
Armor Factor:	72	4.5
	<i>Internal Structure</i>	<i>Armor Value</i>
Head	3	8
Center Torso	12	12
Center Torso (rear)		4
R/L Torso	10	10
R/L Torso (rear)		2
R/L Arm	6	6
R/L Leg	10	6

Weapons and Ammo	Location	Critical	Tonnage
Medium Pulse Laser	RA	1	2
LRM 5	RT	1	2
Ammo (LRM) 24	RT	1	1
Artemis IV FCS	RT	1	1
Jump Jet	CT	1	.5
Jump Jets	RT	3	1.5
Jump Jets	LT	3	1.5

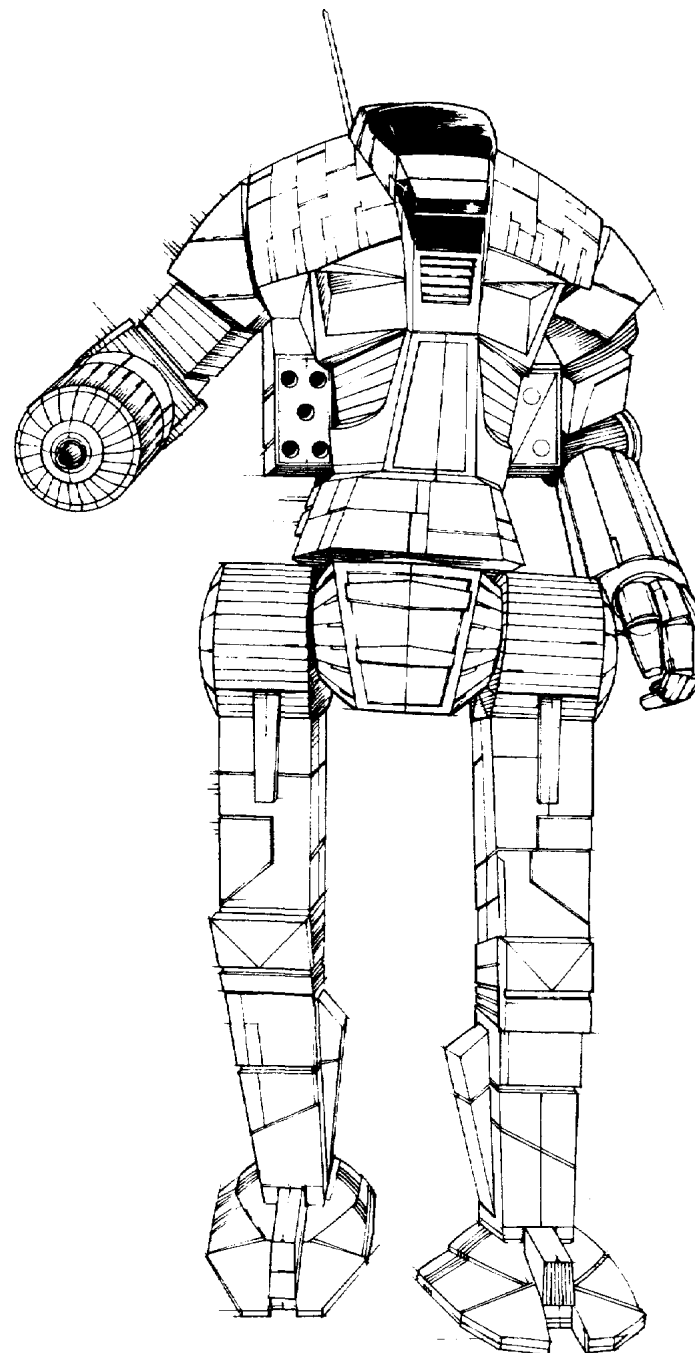



OVERVIEW

The Free Worlds League, the only producer of the *Cicada* since the fall of the Star League, has given this design increasing priority in recent years. The availability of recovered Star League technology is expected to continue this trend, as blueprints obtained by ComStar indicate that the *Cicada* will benefit even more from upgrading than most 'Mechs. The plans, obtained by Adept XV-rho Karel Tzowsz on the planet Gibson, show that Marik military planners intend to use recovered technology to keep the *Cicada's* greatest asset—speed—while eliminating its biggest headache, excessive heat build-up. At the same time, the new model will receive upgraded weapons and armor protection.

The incorporation of double heat sinks will virtually eliminate the *Cicada's* problems with heat build-up. Installation of the reliable Hermes 320 XL will significantly reduce the 'Mech's weight, allowing it to carry more and heavier weapons. The plans call for replacing the Magna 200 small laser with the new Magna 200P small pulse laser and adding an Emperor Ultra-5 autocannon. These changes will make the *Cicada* a far more powerful foe. To make sure that the Emperor's ammunition does not become a liability, designers plan to install Cellular Ammunition Storage Equipment. As a package, the CDA-3M *Cicada* may provide a rude awakening for enemies of the Free Worlds League.

Mass: 40 tons
Chassis: Kell Reinforced 240
Power Plant: Pitban 320 XL
Cruising Speed: 86.4 kph
Maximum Speed: 129.6 kph
Jump Jets: None
Jump Capacity: None
Armor: Durallex Light with CASE
Armament:
 2 Magna Mark II Medium Lasers
 1 Imperator Ultra Autocannon/5
 1 Magna 200P Small Pulse Laser
Manufacturer: Free Worlds Defense Industries
Primary Factory: Gibson
Communications System: Datacom 50
Targeting and Tracking System: Dynatec 1122

Type: Cicada
Technology Base: Inner Sphere
Tonnage: 40

Equipment		Mass
Internal Structure:		4
Engine:	320 XL	11.5
Walking MP:	8	
Running MP:	12	
Jumping MP:	0	
Heat Sinks:	10 [20]	0
Gyro:		4
Cockpit:		3
Armor Factor:	64	4

	Internal Structure	Armor Value
Head	3	9
Center Torso	12	11
Center Torso (rear)		6
R/L Torso	10	6
R/L Torso (rear)		3
R/L Arm	6	4
R/L Leg	10	6

Weapons and Ammo	Location	Critical	Tonnage
Medium Laser	RT	1	1
Medium Laser	LT	1	1
Ultra AC/5	LT	5	9
Ammo (Ultra) 20	RT	1	1
CASE	RT	1	.5
Small Pulse Laser	CT	1	1

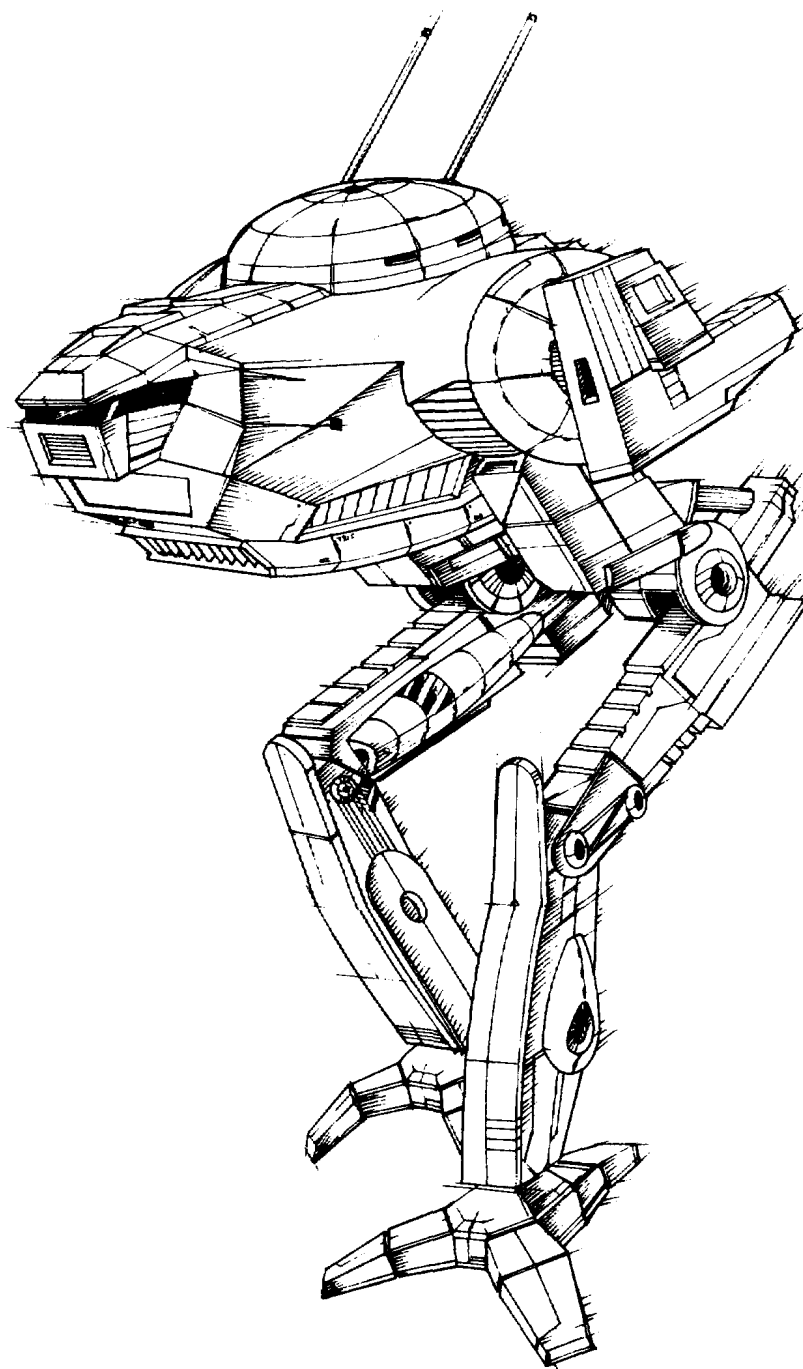



OVERVIEW

Never produced in great numbers, the *Clint* has become something of an oddity on the modern-day battlefield. ComStar estimates that no more than two hundred *Clints* still exist in Successor State armies and mercenary units. The shortage of ammunition for the 'Mech's Armstrong autocannon is a serious drawback on the battlefield, and is the likeliest reason why no Successor State has attempted to put the *Clint* back into production.

Though individual MechWarriors have modified their *Clints* in many different ways over the years, the new field modification kit issued by the Capellan Confederation shows great promise. It replaces the autocannon with the new Magna Firestar extended-range particle projection cannon, eliminating the ammunition shortage and creating enough room to upgrade the medium lasers to medium pulse lasers.

Though this variant has yet to see action, this modification package is expected to greatly improve the *Clint's* performance. If the model shows sufficient promise, a Successor State manufacturer may yet resume factory production of the *Clint* to take advantage of structural improvements, such as extra-light engines or ferro-fibrous armor.

Mass: 40 tons
Chassis: Andoran Model III
Power Plant: Pitban 240
Cruising Speed: 64.8 kph
Maximum Speed: 97.2 kph
Jump Jets: Andoran Model JIII
Jump Capacity: 180 meters

Armor: Durallex Medium

Armament:

- 1 Magna Firestar Extended-Range PPC
- 2 Magna 400P Medium Pulse Lasers

Manufacturer: Andoran Industries Ltd.

Primary Factory: Bell

Communications System: Raldon R1

Targeting and Tracking System: Sloane 220 Lockover System

Type: **Clint**

Technology Base: Inner Sphere

Tonnage: 40

Equipment

		Mass
Internal Structure:		4
Engine:	240	11.5
Walking MP:	6	
Running MP:	9	
Jumping MP:	6	
Heat Sinks:	10 [20]	0
Gyro:		3
Cockpit:		3
Armor Factor:	72	4.5

	<i>Internal Structure</i>	<i>Armor Value</i>
--	---------------------------	--------------------

Head	3	9
Center Torso	12	11
Center Torso (rear)		4
R/L Torso	10	6
R/L Torso (rear)		4
R/L Arm	6	6
R/L Leg	10	8

Weapons and Ammo

	Location	Critical	Tonnage
ER PPC	RA	3	7
Medium Pulse Laser	CT	1	2
Medium Pulse Laser	LT	1	2
Jump Jets	RL	2	1
Jump Jets	LL	2	1
Jump Jet	RT	1	.5
Jump Jet	LT	1	.5

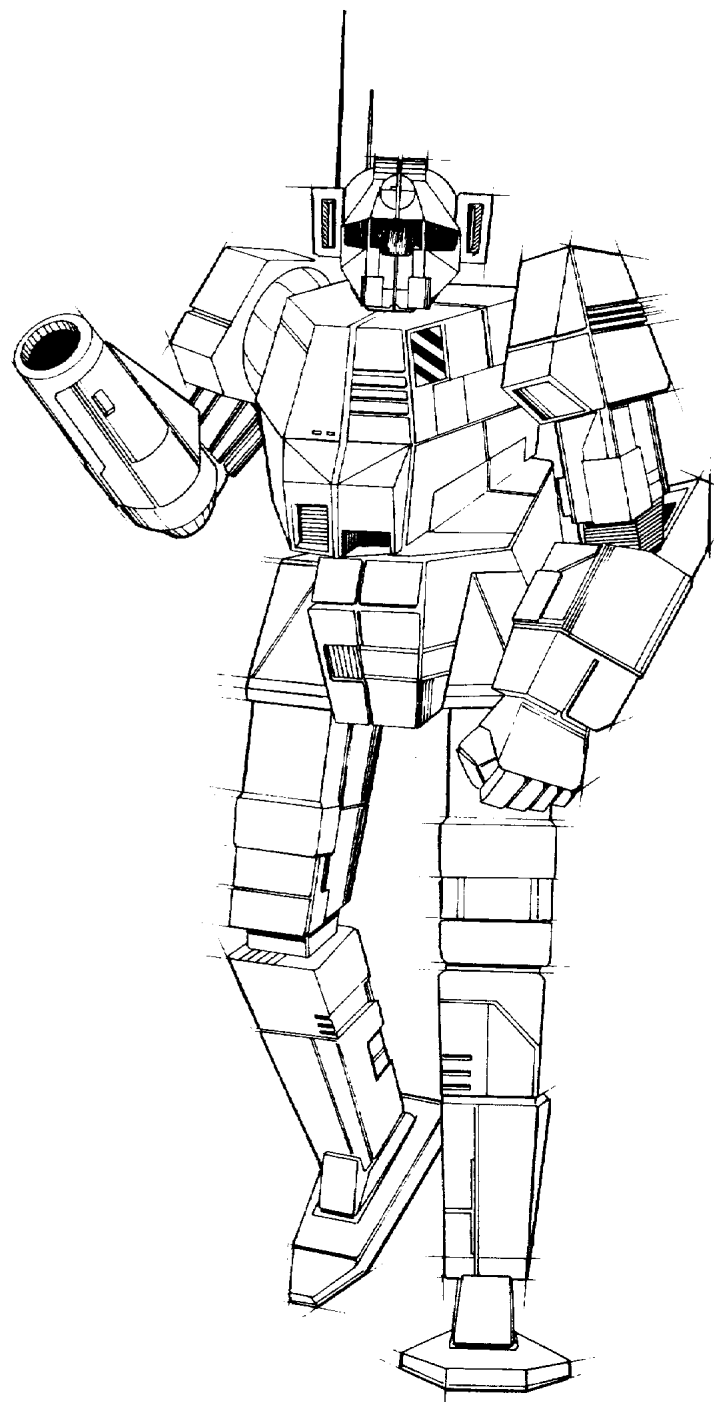

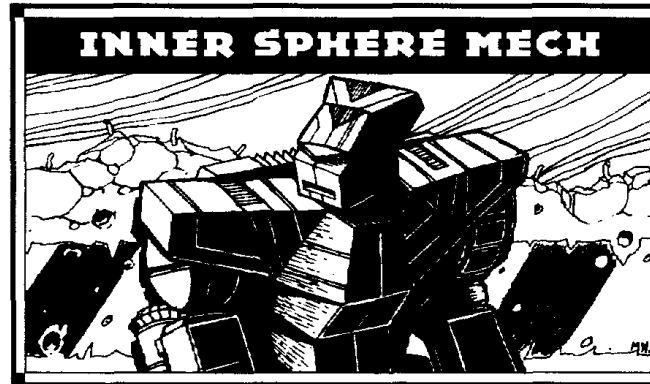

OVERVIEW

In addition to resuming limited production of the original *Hermes* BattleMech, Irian BattleMechs Unlimited has just completed an overhaul of its assembly line for the *Hermes II*. The new model HER-5S is another example of House Marik's excellent use of Star League technology to improve existing designs.

The use of the Irian Second Generation Class 40 endo steel chassis has reduced the weight of the 'Mech's internal structure enough to allow Irian to improve the weapon systems. The use of double heat sinks should eliminate any concerns about heat buildup in the new model.

An Emperor Ultra-5 autocannon replaces the old Oriente AC/5, and an Intek medium pulse laser replaces the aging medium laser produced by Irian Weapons Works. Front-line units are reported to be eagerly awaiting the new *Hermes II*, with the first 'Mechs slated for the elite First Guards. It will be at least six months before any other unit can hope to see the new *Hermes II*.

HER-5S HERMES II

MEDIUM 'MECHS 89

Mass: 40 tons
Chassis: Irian Second Generation Class 40 Endo Steel
Power Plant: Pitban 240
Cruising Speed: 64.8 kph
Maximum Speed: 97.2 kph
Jump Jets: None
Jump Capacity: None
Armor: Riese-456
Armament:
 1 Emperor Ultra Autocannon/5
 1 Olympian Flamer
 1 Intek Medium Pulse Laser
Manufacturer: Irian BattleMechs Unlimited
Primary Factory: Irian, Shiro III
Communications System: Irian E.A.R.
Targeting and Tracking System: Wasat Aggressor

Type: **Hermes II**
 Technology Base: Inner Sphere
 Tonnage: 40

Equipment		Mass
Internal Structure:	Endo	2
Engine:	240	11.5
Walking MP:	6	
Running MP:	9	
Jumping MP:	0	
Heat Sinks:	10 [20]	0
Gyro:		3
Cockpit:		3
Armor Factor:	120	7.5
	<i>Internal Structure</i>	<i>Armor Value</i>
Head	3	9
Center Torso	12	17
Center Torso (rear)		6
R/L Torso	10	14
R/L Torso (rear)		5
R/L Arm	6	11
R/L Leg	10	14

Weapons and Ammo	Location	Critical	Tonnage
Ultra AC/5	RT	5	9
Ammo (Ultra) 20	LT	1	1
Flamer	LA	1	1
Medium Pulse Laser	RA	1	2

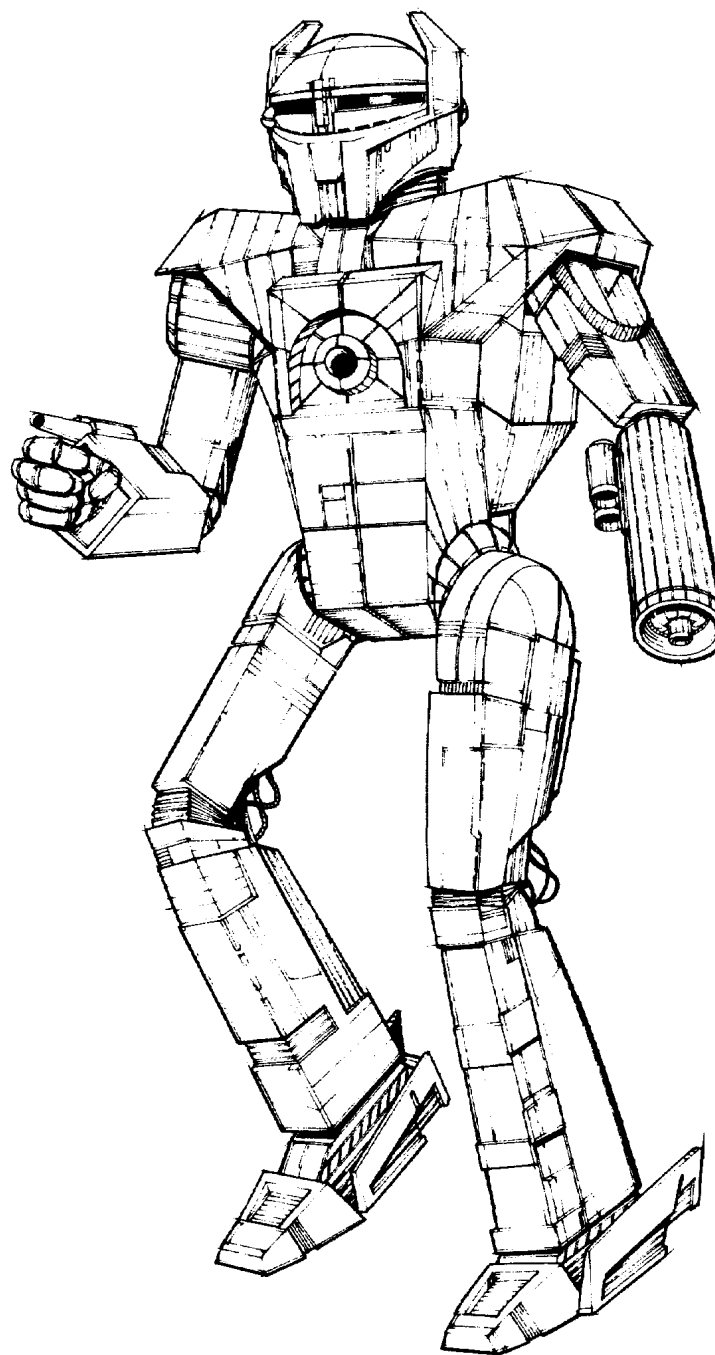



OVERVIEW

The *Sentinel*, a Star League-era design secretly supplied by ComStar to the Draconis Combine in the 3030s, fought its first battle in centuries during the Kurita counterthrust at the Davion planet Exeter during the War of 3039. Along with the *Crab*, the *Sentinel* played a major role in the Combine's destruction of vast areas of the planet. The appearance of the Star League design confused and frightened the Davion MechWarriors, who had not been trained to fight these 'Mechs from the past. Some experts argue that the 'Mech's effect on enemy morale alone turned the tide in at least three battles fought during that war.

Unlike the Com Guards' *Sentinels*, which incorporate a Streak short-range missile system into their weapons array, House Kurita's *Sentinels* are equipped with the common Marklin Mini SRM-2 launcher. Some Kurita MechWarriors have complained about the Marklin, but given its solid record in combat, the complaints likely arise more from Kurita distaste for using a "foreign" weapons system produced by the Magistracy of Canopus than from genuine weaknesses in performance.

STN-3M SENTINEL

Mass: 40 tons
Chassis: Defiant V
Power Plant: Pitban 240
Cruising Speed: 65 kph
Maximum Speed: 97 kph
Jump Jets: None
Jump Capacity: None
Armor: Valiant Lamellor
Armament:
 1 KWI AC/5 Ultra Autocannon
 1 Marklin Mini SRM-2 Missile Rack
 1 Magna Mark II Medium Laser
Manufacturer: Defiance Industries
Primary Factory: Hesperus
Communications System: StarLink/Benicia Model AS829G
Targeting and Tracking System: Targa-7, Vid-Com-17

Type: Sentinel
Technology Base: Inner Sphere
Tonnage: 40

Equipment		Mass
Internal Structure:		4
Engine:	240	11.5
Walking MP:	6	
Running MP:	9	
Jumping MP:	0	
Heat Sinks:	10	0
Gyro:		3
Cockpit:		3
Armor Factor:	88	5.5

	Internal Structure	Armor Value
Head	3	9
Center Torso	12	10
Center Torso (rear)		7
R/L Torso	10	8
R/L Torso (rear)		5
R/L Arm	6	8
R/L Leg	10	10

Weapons and Ammo	Location	Critical	Tonnage
Ultra AC/5	LA	5	9
Ammo (Ultra) 20	LT	1	1
SRM 2	RT	1	1
Ammo (SRM) 50	RT	1	1
Medium Laser	RT	1	1

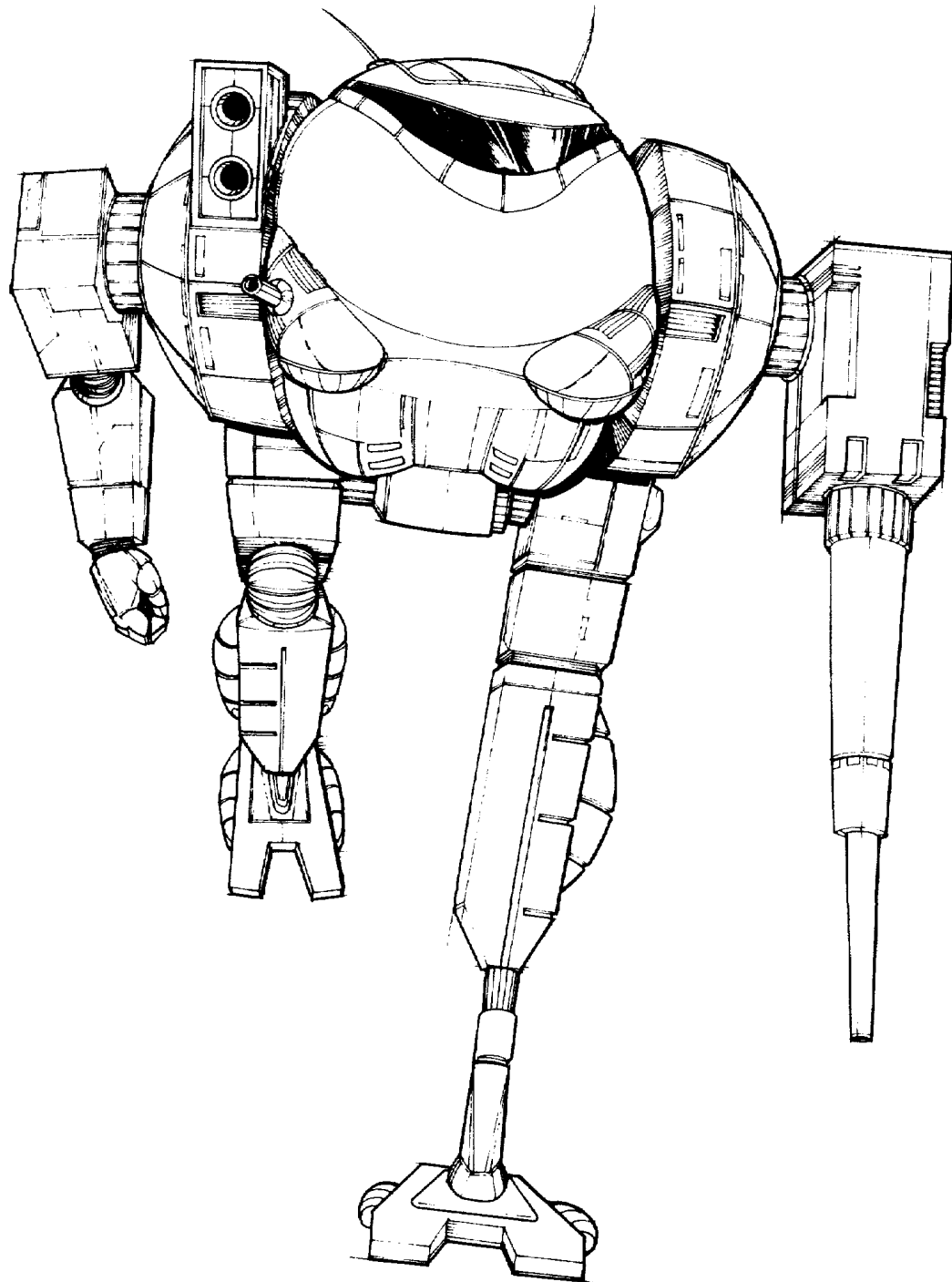



OVERVIEW

The Free Worlds League is applying Star League-era technology to make the *Vulcan*, an effective city fighter and anti-infantry 'Mech, into a more potent foe against other 'Mechs. Keeping the flamer and machine gun for use against infantry, Nimakachi Fusion Products Ltd. is upgrading the medium laser to a Tronel XII medium pulse laser and installing a Tronel PPL-20 large pulse laser in place of the autocannon in the right torso. The new model's lighter endo steel internal structure offsets the weight gain, and the potential heat problem is averted by installing eleven double heat sinks. Only two such 'Mechs have emerged from the factory on Tematagi, but production is expected to increase as Nimakachi works the kinks out of its assembly line.

The Federated Commonwealth is taking a different approach toward better equipping the *Vulcan* to engage other 'Mechs. The VL-5S variant sticks closer to the original model's weapons mix, with the only change being the installation of an Imperator Ultra-5 autocannon in place of the older Armstrong model. The VL-5S, produced by Coventry Metal Works, frees up the extra weight needed for the Ultra autocannon by using the proven Edasich Motors 240 XL engine rather than an endo steel internal structure.

Coventry also appears more concerned with survivability than with heat. The VL-5S keeps the original *Vulcan*'s ten heat sinks, but adds other equipment to make the *Vulcan* pilot safer. The use of Lexington Ltd. High Grade ferro-fibrous armor offers much better protection for the right and left torso and legs with the same amount of weight. This design also has Cellular Ammunition Storage Equipment to protect the autocannon shells and Myomer Accelerator Signal Circuitry to let the 'Mech leave the battlefield in a hurry when all else fails.

Mass: 40 tons
Chassis: Crucis-II Deluxe Endo Steel
Power Plant: Pitban 240
Cruising Speed: 64.8 kph
Maximum Speed: 97.2 kph
Jump Jets: Rawlings 75
Jump Capacity: 180 meters

Armor: Kallon Royalstar

Armament:
 1 Tronel PPL-20 Large Pulse Laser
 1 Tronel XII Medium Pulse Laser
 1 Flame Tech Flamer
 1 LFN Lindblad Machine Gun

Manufacturer: Nimakachi Fusion Products Ltd.

Primary Factory: Tematagi

Communications System: Omicron 4002 Networking Channel

Targeting and Tracking System: TRSS Eagle Eye

Type: **Vulcan**
 Technology Base: Inner Sphere
 Tonnage: 40

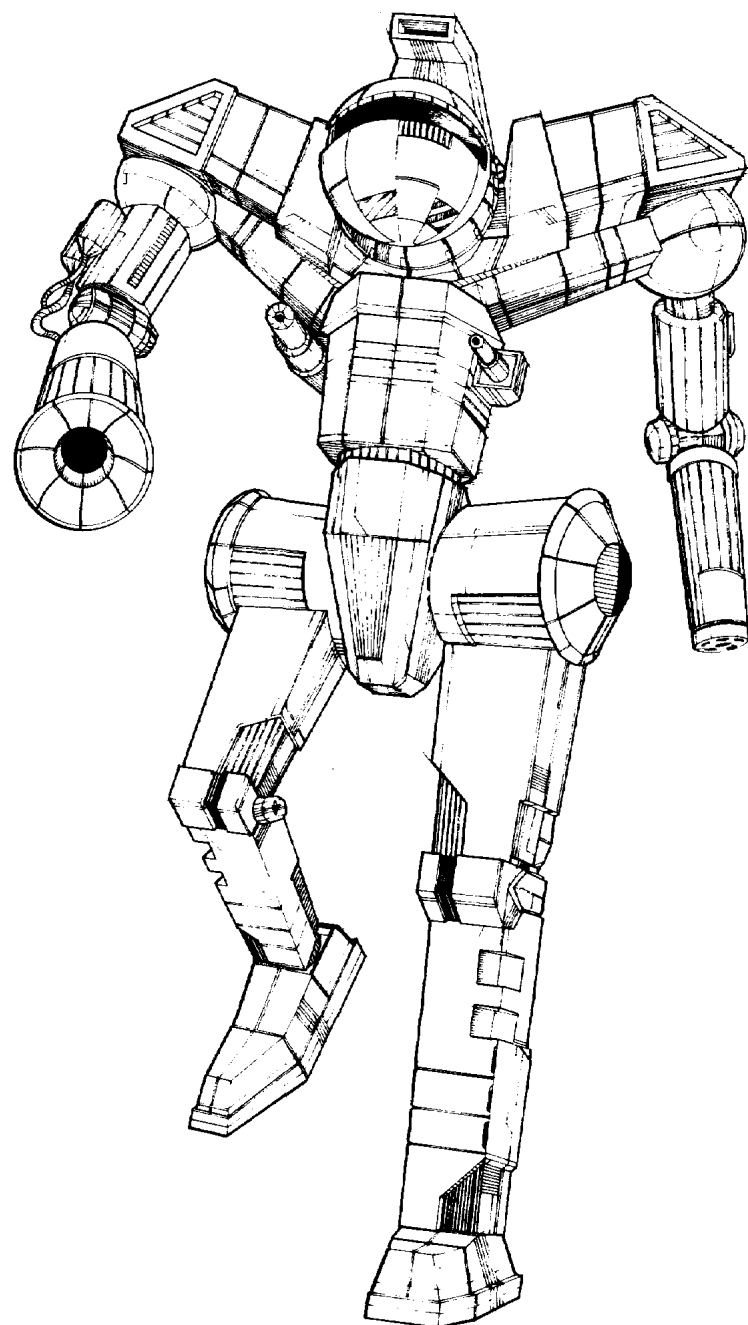

Equipment		Mass
Internal Structure:	Endo	2
Engine:	240	11.5
Walking MP:	6	
Running MP:	9	
Jumping MP:	6	
Heat Sinks:	11 [22]	1
Gyro:		3
Cockpit:		3
Armor Factor:	80	5

	Internal Structure	Armor Value
Head	3	8
Center Torso	12	10
Center Torso (rear)		6
R/L Torso	10	8
R/L Torso (rear)		4
R/L Arm	6	6
R/L Leg	10	10

Weapons and Ammo	Location	Critical	Tonnage
Large Pulse Laser	RT	2	7
Medium Pulse Laser	LT	1	2
Flamer	RA	1	1
Machine Gun	LA	1	.5
Ammo (MG) 200	LT	1	1
Jump Jets	CT	2	1
Jump Jets	LT	2	1
Jump Jets	RT	2	1



OVERVIEW

The *Whitworth* has been out of production since the forces of Stefan Amaris destroyed the *Whitworth* factory on Dieron during the Star League's final days, but several Inner Sphere military units, primarily Kurita and Davion units, continue to employ the design. The *Whitworth's* designers originally envisioned the machine as a close-range weapon, but its slow speed and relatively light armor make it ill suited for such tactics—a fact that became immediately apparent during its first battlefield appearances.

Consequently, the *Whitworth's* designers re-conceived the 'Mech as a long-range fighter and replaced the original design's short-range missile launchers with long-range racks. The modification successfully transformed the *Whitworth* into an effective long-range weapon, although enemy MechWarriors soon discovered that they could cripple or destroy *Whitworths* by simply waiting for a *Whitworth* MechWarrior to expend his missile load and then closing in and attacking. Davion and Kurita engineers responded to this vulnerability by designing field-modification kits for replacing the *Whitworth's* arm-mounted medium lasers with Artemis IV fire-control systems, which greatly improves the accuracy of the design's long-range missiles and lessens the chances that opponents will manage to close with a *Whitworth*.

WHT-2 WHITWORTH

Mass: 40 tons
Chassis: Whitworth Type I
Power Plant: LTV 160
Cruising Speed: 43.2 kph
Maximum Speed: 64.8 kph
Jump Jets: Whitworth Jetlift
Jump Capacity: 120 meters
Armor: Durallex Light
Armament:
 2 Longbow-10 LRM Launchers
 1 Intek Medium Laser
Manufacturer: Whitworth Company
Primary Factory: Dieron
Communications System: Garret T14
Targeting and Tracking System: Garret D2j with two
 Artemis IV Fire-Control Systems

Type: **Whitworth**
 Technology Base: Inner Sphere
 Tonnage: 40

Equipment		Mass
Internal Structure:		4
Engine:	160	6
Walking MP:	4	
Running MP:	6	
Jumping MP:	4	
Heat Sinks:	10	0
Gyro:		2
Cockpit:		3
Armor Factor:	128	8

	Internal Structure	Armor Value
Head	3	9
Center Torso	12	16
Center Torso (rear)		7
R/L Torso	10	12
R/L Torso (rear)		6
R/L Arm	6	12
R/L Leg	10	18

Weapons and Ammo	Location	Critical	Tonnage
LRM 10	RT	2	5
Ammo (LRM) 12	RT	1	1
Artemis IV FCS	RT	1	1
LRM 10	LT	2	5
Ammo (LRM) 12	LT	1	1
Artemis IV FCS	LT	1	1
Medium Laser	H	1	1
Jump Jets	RL	2	1
Jump Jets	LL	2	1

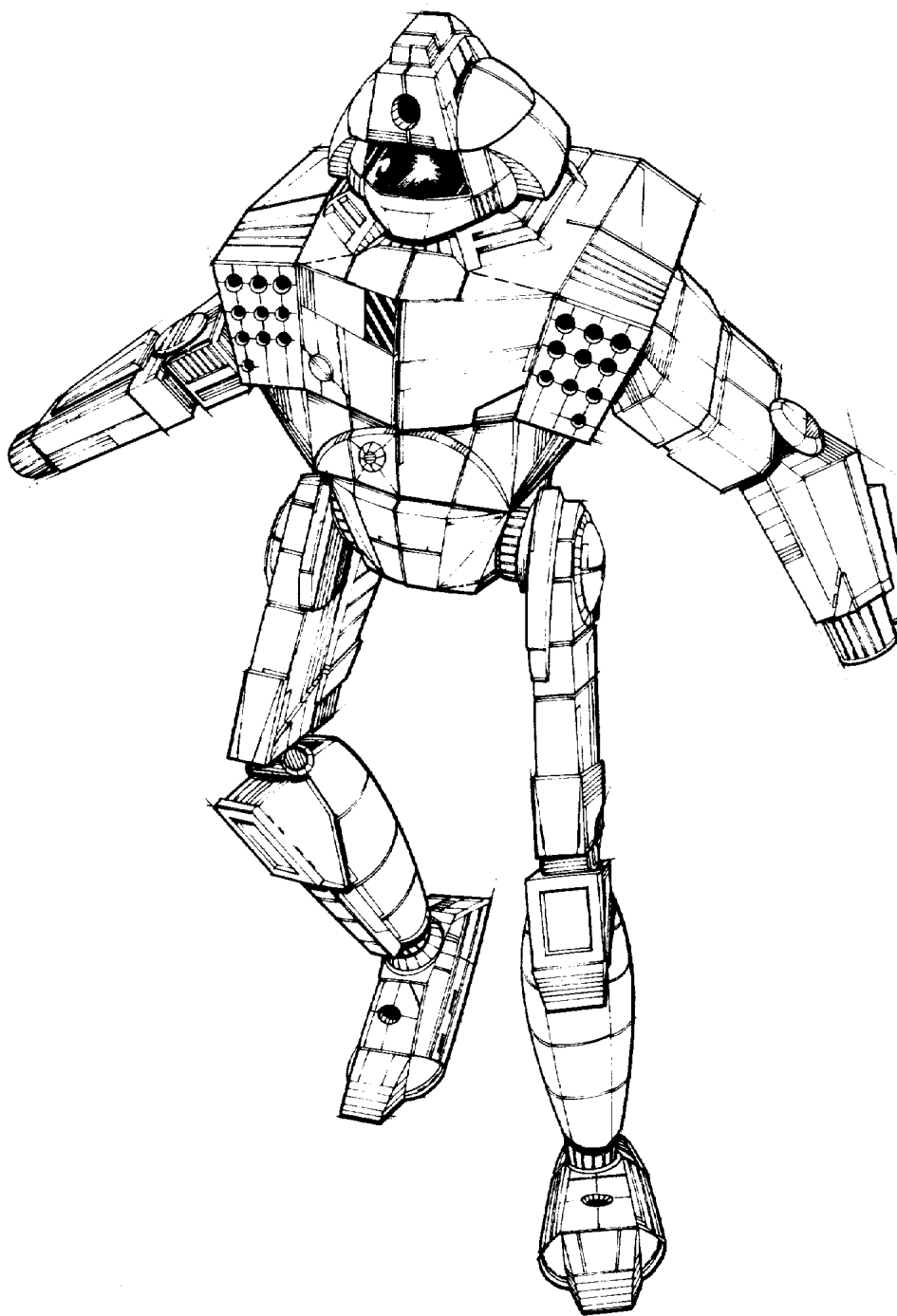



OVERVIEW

Few mourned the destruction of General Motors' *Blackjack* factory on Kathil during the First Succession War. Common only in Davion and Liao space, the *Blackjack* was never a highly regarded 'Mech. Technicians in the Federated Suns, however, saw promise in the design and kept tinkering with its configuration.

The recent availability of Star League technology has given Davion engineers more to work with, and the result promises to be a field modification kit for Federated Commonwealth units that contain *Blackjacks*. The focus of these modifications is the weapons array, and the configuration that seems to be gaining favor is a radical one.

Experimental models, designated the BJ-2, mount a Diverse Optics Sunbeam extended-range large laser in each arm, which is especially unusual on such a light 'Mech. These models replace all four of the original design's medium lasers with Hovertec Streak SRM-2 pods. This configuration conserves ammunition so well that two tons of reloads are plenty for the four pods.

Mass: 45 tons
Chassis: GM BJ-I
Power Plant: GM 180
Cruising Speed: 43.2 kph
Maximum Speed: 64.8 kph
Jump Jets: Whitworth Jetlift
Jump Capacity: 120 meters
Armor: StarGuard II

Armament:
 2 Diverse Optics Sunbeam Extended Range Large Lasers
 4 Hovertec Streak SRM-2 Pods

Manufacturer: General Motors
Primary Factory: Kathil
Communications System: Dalban Micronics
Targeting and Tracking System: Dalban AQ

Type: **Blackjack**
 Technology Base: Inner Sphere
 Tonnage: 45

Equipment		Mass
Internal Structure:		4.5
Engine:	180	7
Walking MP:	4	
Running MP:	6	
Jumping MP:	4	
Heat Sinks:	11	1
Gyro:		2
Cockpit:		3
Armor Factor:	136	8.5

	Internal Structure	Armor Value
Head	3	9
Center Torso	14	18
Center Torso (rear)		9
R/L Torso	11	15
R/L Torso (rear)		6
R/L Arm	7	12
R/L Leg	11	17

Weapons and Ammo	Location	Critical	Tonnage
ER Large Laser	RA	2	5
ER Large Laser	LA	2	5
Streak SRM 2	LT	1	1.5
Streak SRM 2	LT	1	1.5
Ammo (Streak) 50	LT	1	1
Streak SRM 2	RT	1	1.5
Streak SRM 2	RT	1	1.5
Jump Jets	RL	2	1
Jump Jets	LL	2	1

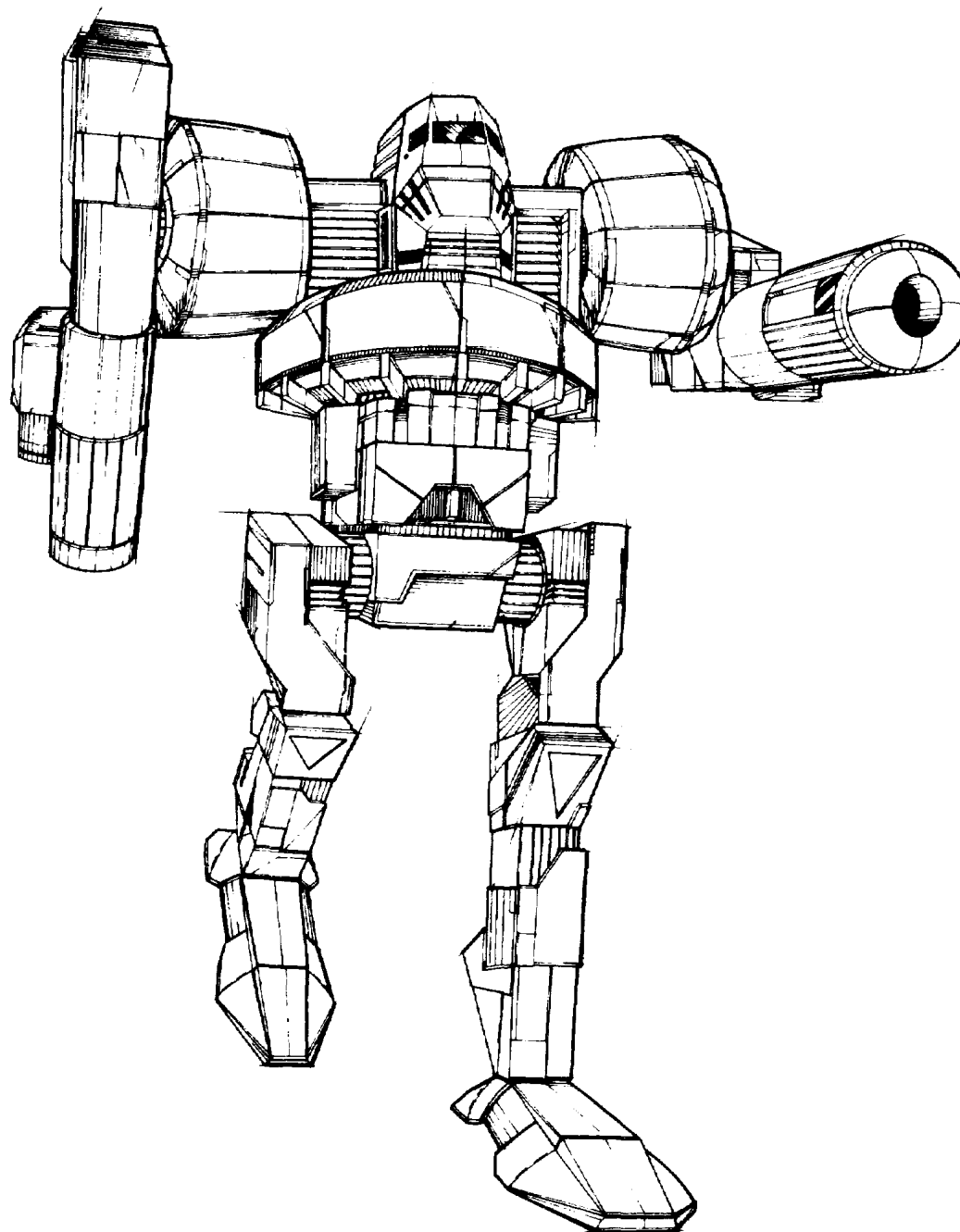

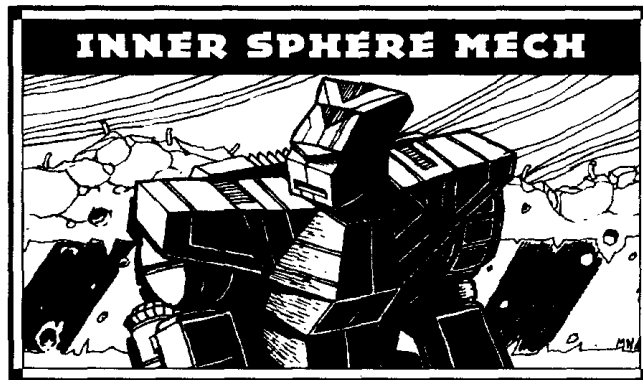

OVERVIEW

The HCT-5S *Hatchetman* is a modern version of the original *Hatchetman* that was first introduced in 3023. The HCT-5S features the Edasich Motors 180 XL engine, along with numerous new weapons, such as the Defiance Disintegrator LB 10-X autocannon, which replaces the original design's Defiance Killer AC/10. The new *Hatchetman* also boasts three Defiance P5M medium pulse lasers, as well as the new Durallex Super Medium ferro-fibrous armor, which gives the HCT-5S nearly twice the protection as the design's original armor. Additionally, the HCT-5S features Cellular Ammunition-Storage Equipment to protect its autocannon shells from internal explosions.

Originally, House Davion employed the design exclusively, but in 3046 a complete *Hatchetman* unit, the Pleiades Lancers, appeared among Taurian Concordat forces. This phenomenon alarmed Davion intelligence analysts, who feared that the Taurians had obtained blueprints for the design. Later, Davion analysts discovered a much less alarming explanation for the Pleiades Lancers. Apparently, the Lancers were an offshoot of Richard's Panzer Brigade, a loyal Lyran mercenary unit that had purchased a number of *Hatchetmen* during the late 3020s. When the Lyrans and House Davion joined together to form the Federated Commonwealth, the Panzer Brigade left Lyran service and signed on with House Liao, only to disintegrate when brigade commander Colonel Richard Whitman died. One of the brigade's offshoots, the Pleiades Lancers, later joined the Taurian Defense Forces.

HCT-5S HATCHETMAN

Mass: 45 tons
Chassis: Chariot Type II
Power Plant: GM 180 XL
Cruising Speed: 43.2 kph
Maximum Speed: 64.8 kph
Jump Jets: Luxor 2/Q
Jump Capacity: 120 meters
Armor: Durallex Super Medium Ferro-Fibrous with CASE
Armament:
 1 Defiance Disintegrator LB 10-X Autocannon
 3 Defiance P5M Medium Pulse Lasers
Manufacturer: Defiance Industries
Primary Factory: Hesperus
Communications System: TharHes Thalia HM-22
Targeting and Tracking System: TharHes Ares-8a

Type: **Hatchetman**
 Technology Base: Inner Sphere
 Tonnage: 45

Equipment		Mass
Internal Structure:		4.5
Engine:	180 XL	3.5
Walking MP:	4	
Running MP:	6	
Jumping MP:	4	
Heat Sinks:	10	0
Gyro:		2
Cockpit:		3
Armor Factor:	152	8.5

	Internal Structure	Armor Value
Head	3	9
Center Torso	14	21
Center Torso (rear)		6
R/L Torso	11	16
R/L Torso (rear)		6
R/L Arm	7	14
R/L Leg	11	22

Weapons and Ammo	Location	Critical	Tonnage
LB 10-X AC	RT	6	11
Ammo (LB-X) 10	RT	1	1
CASE	RT	1	.5
Medium Pulse Laser	RA	1	2
Medium Pulse Laser	LA	1	2
Medium Pulse Laser	LT	1	2
Hatchet	RA	3	3
Jump Jets	RL	2	1
Jump Jets	LL	2	1

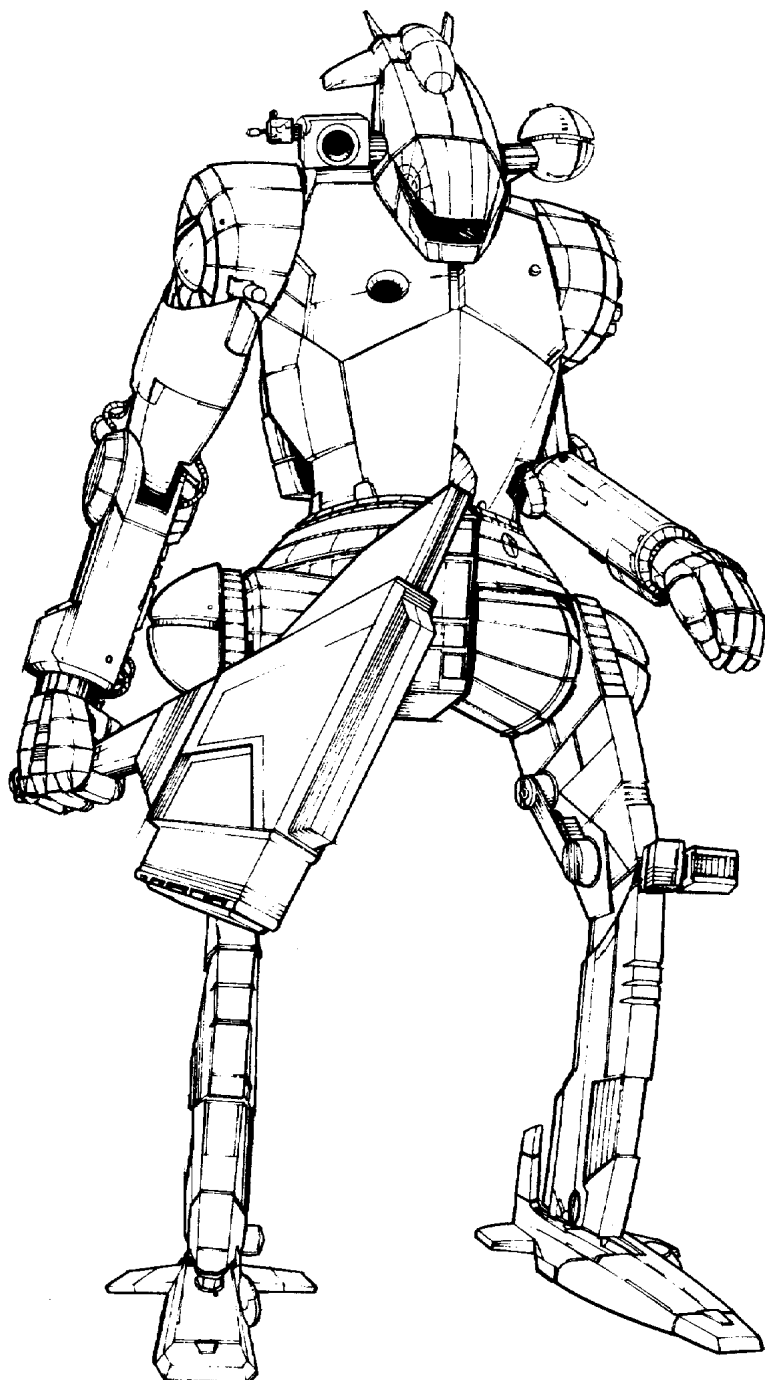



OVERVIEW

The *Vindicator* has become a common 'Mech among the units of the Capellan Confederation, thanks to the impressive production schedule of Ceres Metals Industries. Although some defense analysts believe that the *Vindicator's* capabilities do not justify such wide deployment, even the *Vindicator's* critics agree that the modifications included in Ceres Metals' new VND-3L version corrects many weaknesses of the original VND-1R *Vindicator*.

Perhaps most important, the new *Vindicator* features double heat sinks, a design modification that largely solves the serious heat buildup problems that plagued the VND-1R. Additionally, the new version incorporates Cellular Ammunition-Storage Equipment, which provides superior protection for the *Vindicator's* missile reloads. The new *Vindicator* also features upgraded weapons, such as a head-mounted pulse laser and an arm-mounted Ceres Arms Warrior extended-range particle projection cannon.

VND-3L VINDICATOR

MEDIUM 'MECHS 101

Mass: 45 tons
Chassis: Cereplex IV
Power Plant: GM 180
Cruising Speed: 43.2 kph
Maximum Speed: 64.8 kph
Jump Jets: Anderson Propulsion 30
Jump Capacity: 120 meters
Armor: Starshield with CASE
Armament:
 1 Sian/Ceres Jaguar LRM Missile System
 1 Ceres Arms Warrior Extended Range PPC
 1 Ceres Arms Model W Medium Pulse Laser
Manufacturer: Ceres Metals Industries
Primary Factory: Capella
Communications System: CeresCom Model 21-Rs
Targeting and Tracking System: C-Apple Churchill

Type: **Vindicator**
 Technology Base: Inner Sphere
 Tonnage: 45

Equipment		Mass
Internal Structure:		4.5
Engine:	180	7
Walking MP:	4	
Running MP:	6	
Jumping MP:	4	
Heat Sinks:	15 [30]	5
Gyro:		2
Cockpit:		3
Armor Factor:	144	9
	<i>Internal Structure</i>	<i>Armor Value</i>
Head	3	9
Center Torso	14	18
Center Torso (rear)		9
R/L Torso	11	16
R/L Torso (rear)		6
R/L Arm	7	14
R/L Leg	11	18

Weapons and Ammo	Location	Critical	Tonnage
LRM 5	LT	1	2
Ammo (LRM) 24	RT	1	1
CASE	RT	1	.5
ER PPC	RA	3	7
Medium Pulse Laser	H	1	2
Jump Jets	CT	2	1
Jump Jet	RL	1	.5
Jump Jet	LL	1	.5

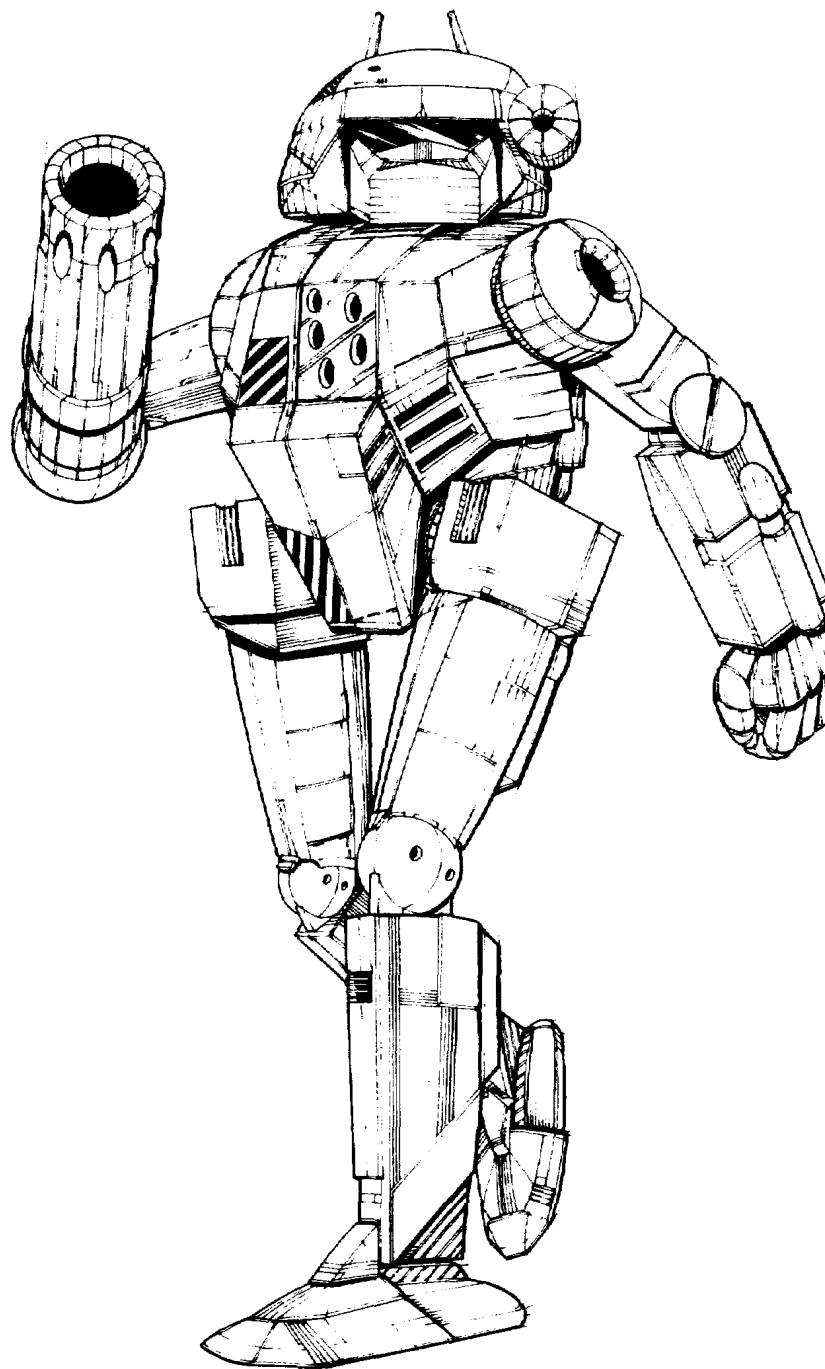

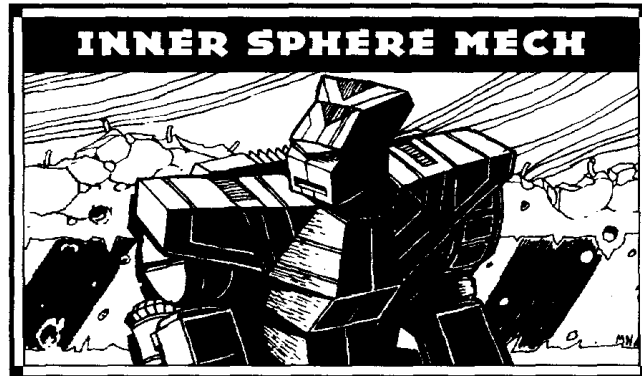

OVERVIEW

House Kurita's *Wolf Trap* was one of the first completely new BattleMech designs to emerge since the Inner Sphere powers began to recover Star League technology, and its success prompted Marik and Capellan efforts to produce new 'Mech designs rather than simply revamp old ones.

Manufactured by Luthien Armor Works, the *Wolf Trap* is a blend of proven systems and advanced technology. The design's endo-steel internal structure and extra-light engine provide the *Wolf Trap* with excellent speed, which negates the need for jump jets. Additionally, the *Wolf Trap* features a weapons array that produces little heat, which negates the need for bulky double heat sinks.

The 'Mech's weaponry is specially designed to deliver heavy damage at long range, but it also includes weapons that provide extensive firepower at shorter ranges. The Victory 23R medium lasers and Shigunga long-range missiles, which are used by 'Mech units throughout Kurita space, form the heart of the *Wolf Trap's* arsenal. The design's lesser-known Emperor Code Red LB 10-X autocannon provides the *Wolf Trap* with substantial striking power as well.

Mass: 45 tons
Chassis: Alshain Class 580 Endo Steel
Power Plant: GM 270 XL
Cruising Speed: 64.9 kph
Maximum Speed: 97.2 kph
Jump Jets: None
Jump Capacity: None
Armor: Durallex Special Medium with CASE
Armament:
 1 Imperator Code Red LB 10-X Autocannon
 2 Victory 23R Medium Lasers
 1 Shigunga LRM-10 Missile Rack
Manufacturer: Luthien Armor Works
Primary Factory: Luthien
Communications System: Sipher Security Plus
Targeting and Tracking System: Eagle Eye 400 XX

Type: Wolf Trap
Technology Base: Inner Sphere
Tonnage: 45

Equipment		Mass
Internal Structure:	Endo	2.5
Engine:	270 XL	7.5
Walking MP:	6	
Running MP:	9	
Jumping MP:	0	
Heat Sinks:	10	0
Gyro:		3
Cockpit:		3
Armor Factor:	120	7.5
	<i>Internal Structure</i>	<i>Armor Value</i>
Head	3	9
Center Torso	14	17
Center Torso (rear)		6
R/L Torso	11	13
R/L Torso (rear)		5
R/L Arm	7	11
R/L Leg	11	15

Weapons and Ammo	Location	Critical	Tonnage
LB 10-X AC	RA	6	11
Ammo (LB-X) 20	RT	2	2
CASE	RT	1	.5
Medium Laser	LT	1	1
Medium Laser	LT	1	1
LRM 10	CT	2	5
Ammo (LRM) 12	RT	1	1

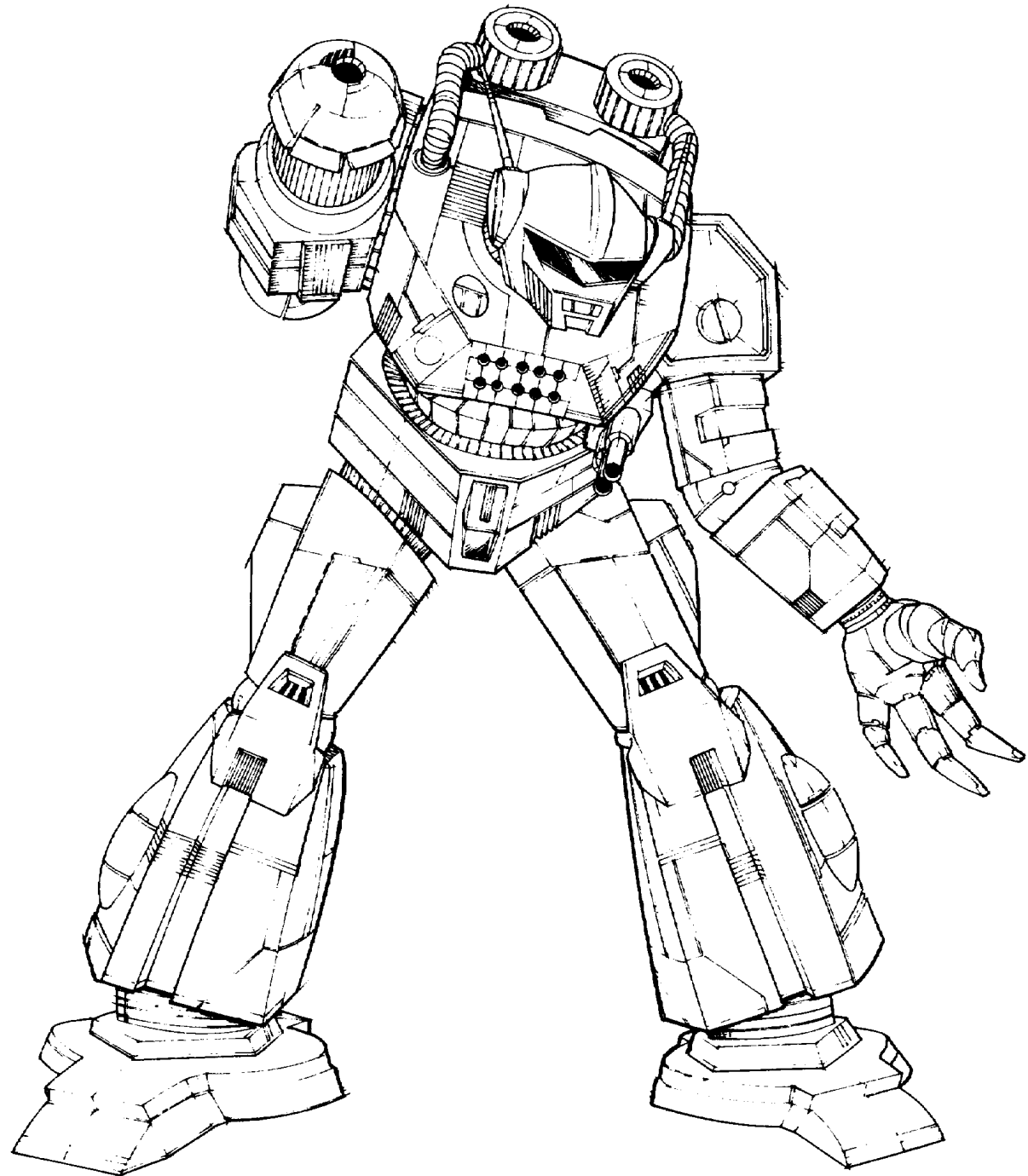

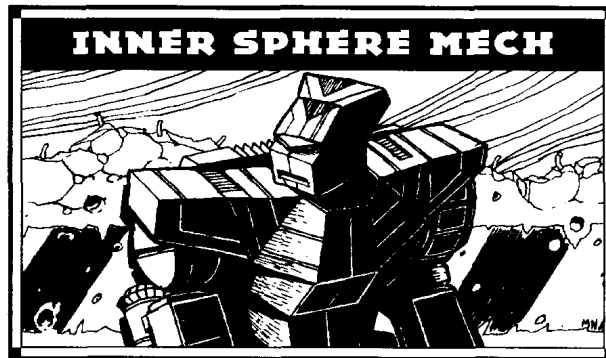

OVERVIEW

Not known as a flashy 'Mech, the *Wyvern* was commissioned late in 2660 for crowd control, garrison duty, security work and urban defense. There are few 'Mechs it cannot handle in a city environment, and for pilots who enjoy those assignments, the *Wyvern* is often their first choice.

Though the *Wyvern* is ideal for city fighting, it can be a sitting duck in open country. With a top flank speed of 65 kph, it cannot escape most of its foes by running away. Even the jump jets in its rear torso and upper legs and the tensile strength of its ferro-fibrous armor are not much help in exposed areas. But in the city, in heavy woods or in mountainous terrain that reduces the maneuverability of faster 'Mechs, the *Wyvern* can use its considerable firepower to full advantage.

The *Wyvern's* main weapon is the arm-mounted Nightwind large laser. The Nightwind's system components have been refined through countless hours of battlefield tests, and so the weapon is extremely reliable, but its bulk makes it one of the largest military lasers ever produced. The two Starflash small lasers, nestled next to their bigger cousin, were added later.

Problems abound with the *Wyvern's* Jackson Dart long-range missile launcher. Because this weapon is located in front of the engine core, the heated engine often causes an automatic shutdown of the launcher system. If pilots try to override the shutdown, the resulting heat build-up can lead to an ammo explosion as the reloads are passed from the CASE in the left torso. The only recourse is to keep the reactor's temperature as low as possible or, if necessary, eject the loaded missiles and disable the autoloader.

The 'Mech's Totschlagen-6 short-range missiles have proven much more stable. The system is housed in the right torso, with the launcher sitting on top of the CASE. The reloading system is extremely compact, making reloading quick and efficient. MechWarriors can usually clear jammed reload tubes by jumping the *Wyvern* up and down.

WVE-5N WYVERN

MEDIUM 'MECHS 105

Mass: 45 tons
Chassis: Ost
Power Plant: GM 180
Cruising Speed: 43 kph
Maximum Speed: 65 kph
Jump Jets: Northrup 750
Jump Capacity: 120 meters

Armor: Kilosh Ferro-Fibrous 1000 with CASE

Armament:

- 1 Jackson Dart LRM-10 Missile Rack
- 1 Nightwind Large Laser
- 2 Starflash Small Lasers
- 1 Totschlagen SRM-6 Missile Rack

Manufacturer: Maltex Corporation

Communications System: Ostmann AMB

Targeting and Tracking System: Scrambler-7 Series

Type: **Wyvern**

Technology Base: Inner Sphere

Tonnage: 45

Equipment		Mass
Internal Structure:	Endo	2.5
Engine:	180	7
Walking MP:	4	
Running MP:	6	
Jumping MP:	4	
Heat Sinks:	12	2
Gyro:		2
Cockpit:		3
Armor Factor:	152	9.5

	Internal Structure	Armor Value
Head	3	9
Center Torso	14	20
Center Torso (rear)		7
R/L Torso	11	16
R/L Torso (rear)		6
R/L Arm	7	14
R/L Leg	11	22

Weapons and Ammo	Location	Critical	Tonnage
LRM 10	CT	2	5
Ammo (LRM) 12	LT	1	1
CASE	LT	1	.5
Large Laser	RA	2	5
Small Laser	RA	1	.5
Small Laser	RA	1	.5
SRM 6	RT	2	3
Ammo (SRM) 15	RT	1	1

Weapons and Ammo	Location	Critical	Tonnage
CASE	RT	1	.5
Jump Jet	LT	1	.5
Jump Jet	RT	1	.5
Jump Jet	LL	1	.5
Jump Jet	RL	1	.5

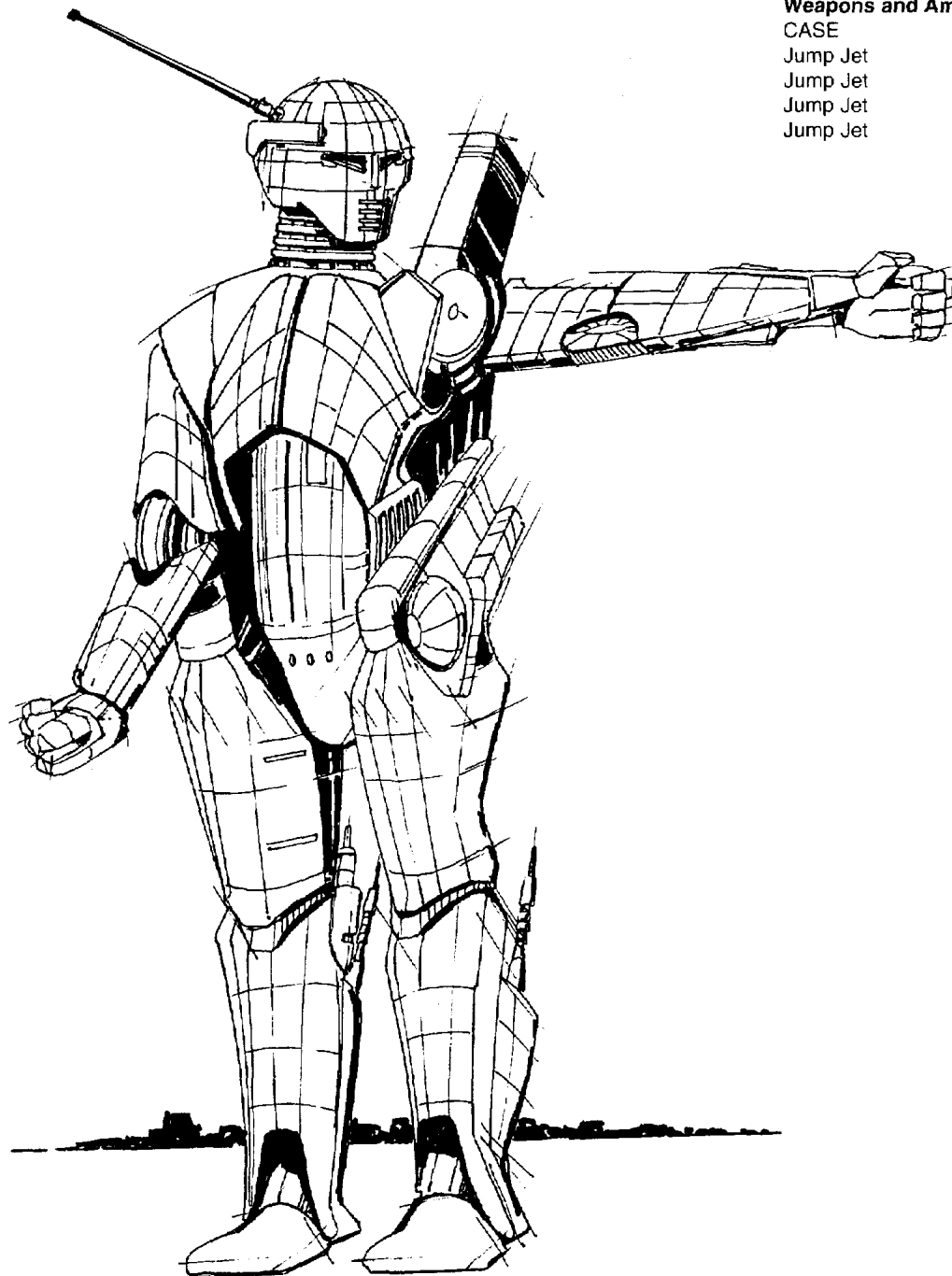



OVERVIEW

The CN9-D *Centurion* is manufactured at Corean Enterprises' New Avalon factory and at Jalastar Aerospace's facility on Panpour. The design combines endo-steel internal structure, extra-light engine technology, Cellular Ammunition-Storage Equipment to guard against an internal missile explosion, and an Artemis IV fire-control system to improve the accuracy of the *Centurion's* Luxor 3R LRM-10 long-range missiles. Additionally, the CN9-D employs a Mydron Excel LB 10-X autocannon in place of the Luxor D-Series autocannon used in earlier versions of the *Centurion*. BattleMech troops have especially welcomed the new autocannon, because spare parts for the Luxor D-Series cannon have always been quite scarce.

Reportedly, Davion engineers continue to test new *Centurion* prototypes that feature improved myomers stable enough for battlefield use, and apparently the Davion military has deployed one such machine against the Clans.

Mass: 50 tons
Chassis: Corean Model KL77 Endo Steel
Power Plant: Vlar 300 XL
Cruising Speed: 64.8 kph
Maximum Speed: 97 kph
Jump Jets: None
Jump Capacity: None
Armor: StarGuard III with CASE
Armament:
 1 Mydron Excel LB 10-X Autocannon
 1 Luxor 3R LRM-10
 2 Photech 806c Medium Lasers
Manufacturer: Corean Enterprises, Jalastar Aerospace
Primary Factory: New Avalon (Corean), Panpour (Jalastar)
Communications System: Corean Transbanc-J9
Targeting and Tracking System: Corean B-Tech with Artemis IV System

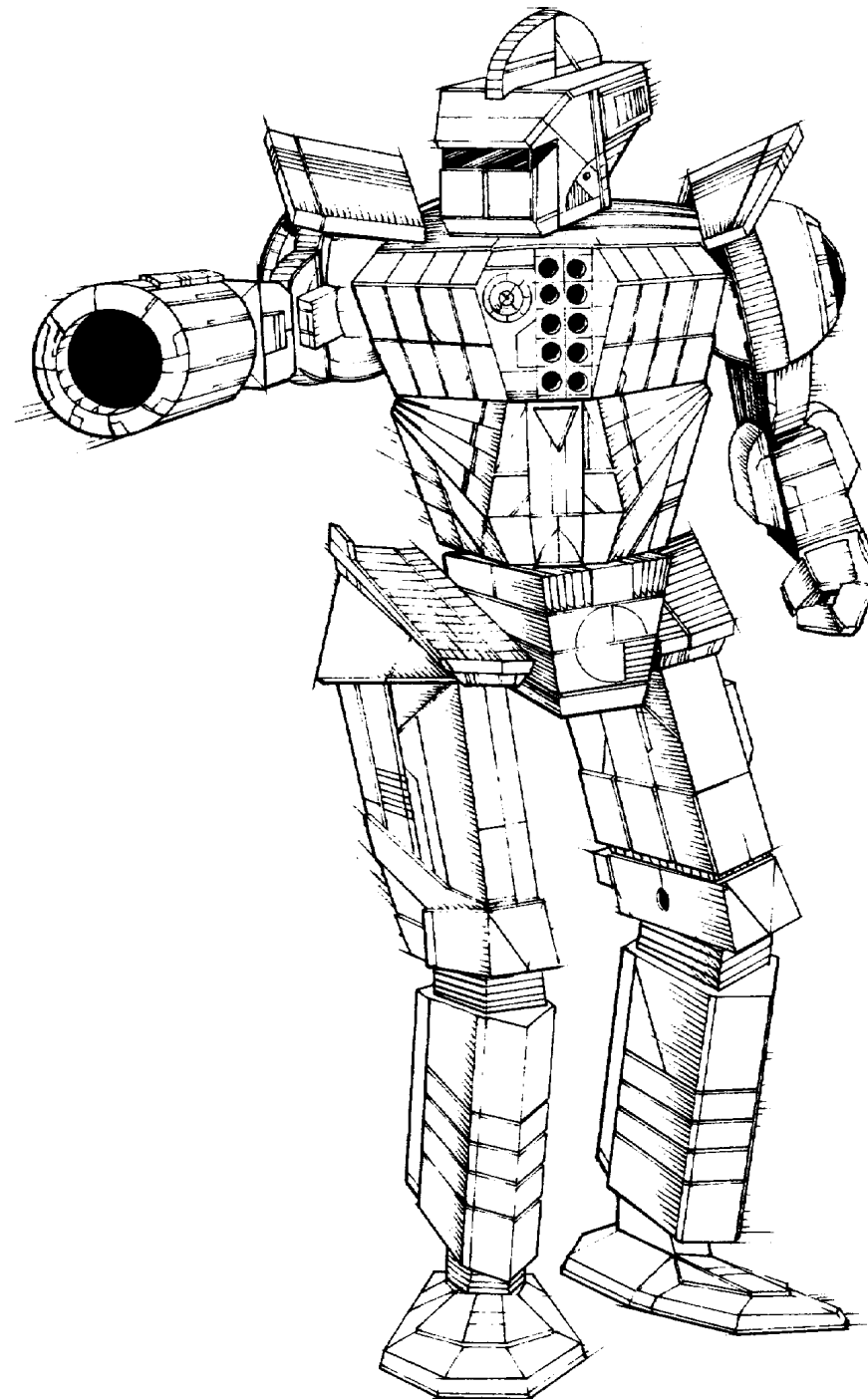

Type: **Centurion**
 Technology Base: Inner Sphere
 Tonnage: 50

Equipment		Mass
Internal Structure:	Endo	2.5
Engine:	300 XL	9.5
Walking MP:	6	
Running MP:	9	
Jumping MP:	0	
Heat Sinks:	10	0
Gyro:		3
Cockpit:		3
Armor Factor:	136	8.5
	<i>Internal Structure</i>	<i>Armor Value</i>
Head	3	9
Center Torso	16	18
Center Torso (rear)		7
R/L Torso	12	13
R/L Torso (rear)		6
R/L Arm	8	16
R/L Leg	12	16

Weapons and Ammo	Location	Critical	Tonnage
LB 10-X AC	RA	6	11
Ammo (LB-X) 20	RT	2	2
LRM 10	LT	2	5
Ammo (LRM) 24	RT	2	2
Artemis IV FCS	LT	1	1
CASE	RT	1	.5
Medium Laser	CT	1	1
Medium Laser	CT (R)	1	1



OVERVIEW

The *Crab* has been well received in Kurita units since ComStar began supplying them to the Draconis Combine in the 3030s. The 'Mech performed well in the War of 3039, surprising Davion units with the weapons hidden inside its claws. In fact, House Kurita would probably make the *Crab* one of its standard designs if it had factories capable of producing the 'Mech.

The weapons have been problem-free, and the Paulina Heavy ferro-fibrous armor offers considerable protection for its tonnage. Though the model supplied to Kurita regiments is merely average compared to the *Crabs* in service with the Com Guards, MechWarriors in the DCMS units where the 'Mech has been deployed all speak highly of it.

The Kurita *Crabs* carry shelf-model Garret communications and targeting gear rather than the sophisticated 650 RND and Dalban Series K systems aboard the Com Guard 'Mechs. House Kurita apparently accepted ComStar's explanation that these systems had not been fully tested and might prove incompatible with the equipment of other Kurita 'Mechs.

Mass: 50 tons
Chassis: Hollis Mark 1A
Power Plant: Magna 250
Cruising Speed: 54 kph
Maximum Speed: 86 kph
Jump Jets: None
Jump Capacity: None
Armor: Paulina Heavy Ferro-Fibrous
Armament:
 2 RAMTech 1200 Large Lasers
 1 Ceres Arms Medium Laser
 1 Exostar Small Laser
Manufacturer: Cosara Weaponries
Primary Factory: Northwind
Communications System: Garret T11-b
Targeting and Tracking System: Garret D2j

Type: Crab
 Technology Base: Inner Sphere
 Tonnage: 50

Equipment		Mass
Internal Structure:		5
Engine:	250	12.5
Walking MP:	5	
Running MP:	8	
Jumping MP:	0	
Heat Sinks:	16	6
Gyro:		3
Cockpit:		3
Armor Factor:	161	9

	Internal Structure	Armor Value
Head	3	9
Center Torso	16	20
Center Torso (rear)		8
R/L Torso	12	16
R/L Torso (rear)		6
R/L Arm	8	16
R/L Leg	12	24

Weapons and Ammo	Location	Critical	Tonnage
Large Laser	LA	2	5
Large Laser	RA	2	5
Medium Laser	CT	1	1
Small Laser	H	1	.5

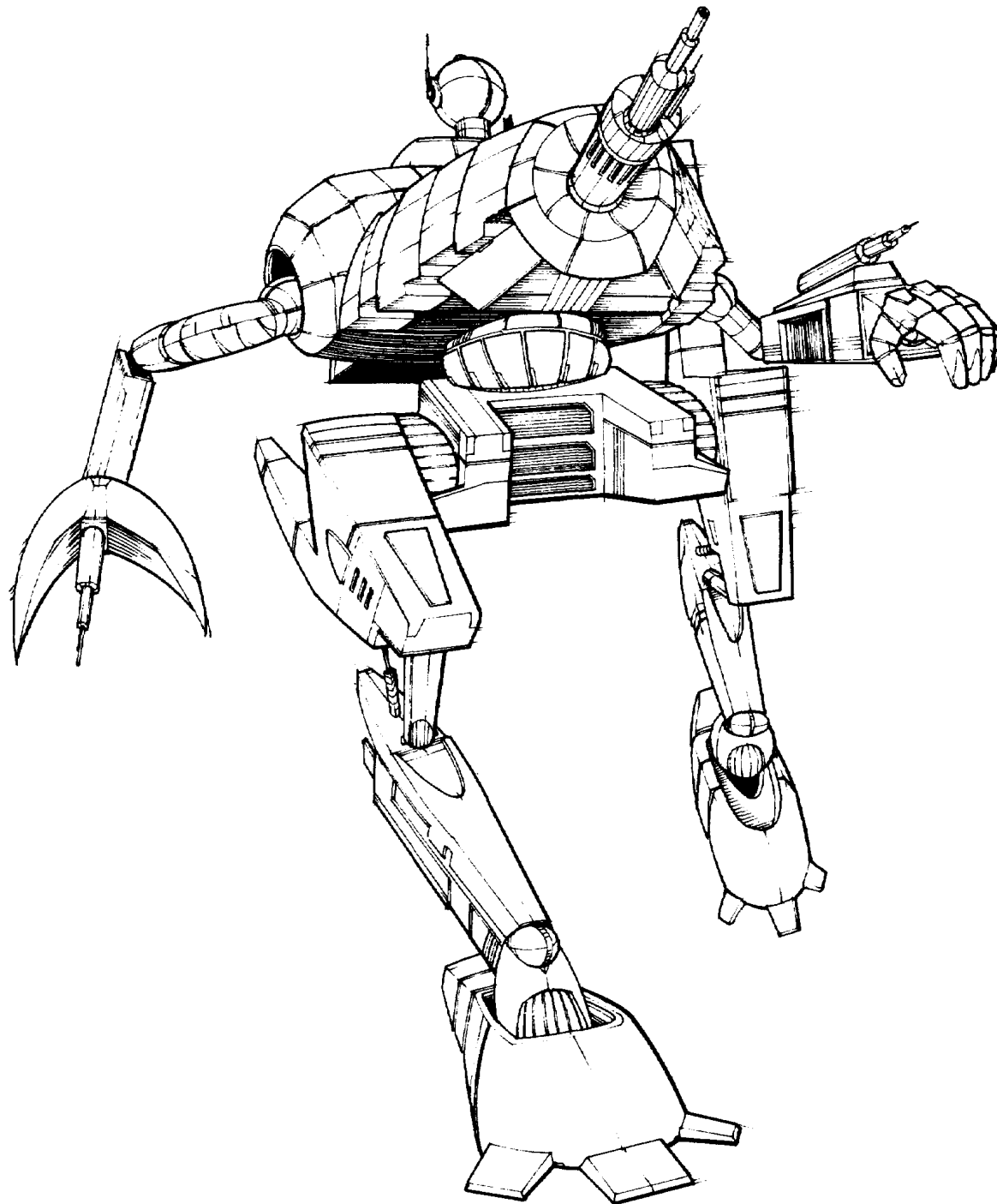

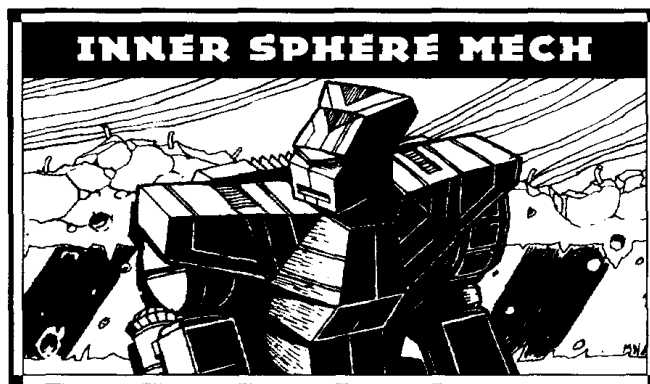

OVERVIEW

The ENF-5D *Enforcer's* superior armor protection, weapon range, speed and jumping ability has made it the standard medium BattleMech design of the Federated Commonwealth.

The ENF-5D's StarGuard CIV ferro-fibrous armor provides greater protection than the original design's armor at half the weight. The new *Enforcer* also boasts Cellular Ammunition-Storage Equipment, which greatly reduces the chance of enemy hits or internal explosions detonating the ENF-5D's autocannon ammunition. A Nissan 250 XL engine provides extra power with less weight, which simultaneously enhances the new *Enforcer's* speed and enables the 'Mech to carry heavier weapons capable of striking at greater ranges, as well as an extra jump jet. Typically, Mydron Excel LB 10-X autocannons replace the Federated AC/10s used on the older *Enforcer*, and BlazeFire Sweetshot extended-range large lasers replace the old ChisComp 43 Specials—modifications that improve the *Enforcer's* effective striking range.

Mass: 50 tons
Chassis: Dorwinion Standard
Power Plant: Magna 250 XL
Cruising Speed: 54 kph
Maximum Speed: 86.4 kph
Jump Jets: McCloud Specials
Jump Capacity: 150 meters
Armor: StarGuard CIV Ferro-Fibrous with CASE

Armament:
 1 Mydron Excel LB 10-X Autocannon
 1 BlazeFire Sweetshot Extended Range Large Laser
 1 ChisComp 32 Small Laser
Manufacturer: Achernar BattleMechs, Kallon Weapon Industries
Primary Factory: New Avalon (Achernar), Talon (Kallon)

Communications System: Achernar Electronics HICS-11
Targeting and Tracking System: Federated Hunter

Type: **Enforcer**
 Technology Base: Inner Sphere
 Tonnage: 50

Equipment		Mass
Internal Structure:		5
Engine:	250 XL	6.5
Walking MP:	5	
Running MP:	8	
Jumping MP:	5	
Heat Sinks:	12	2
Gyro:		3
Cockpit:		3
Armor Factor:	161	9

	Internal Structure	Armor Value
Head	3	9
Center Torso	16	23
Center Torso (rear)		7
R/L Torso	12	19
R/L Torso (rear)		5
R/L Arm	8	16
R/L Leg	12	21

Weapons and Ammo	Location	Critical	Tonnage
LB 10-X AC	RA	6	11
Ammo (LB-X) 20	RT	2	2
CASE	RT	1	.5
ER Large Laser	LA	2	5
Small Laser	LT	1	.5
Jump Jet	CT	1	.5
Jump Jets	RT	2	1
Jump Jets	LT	2	1

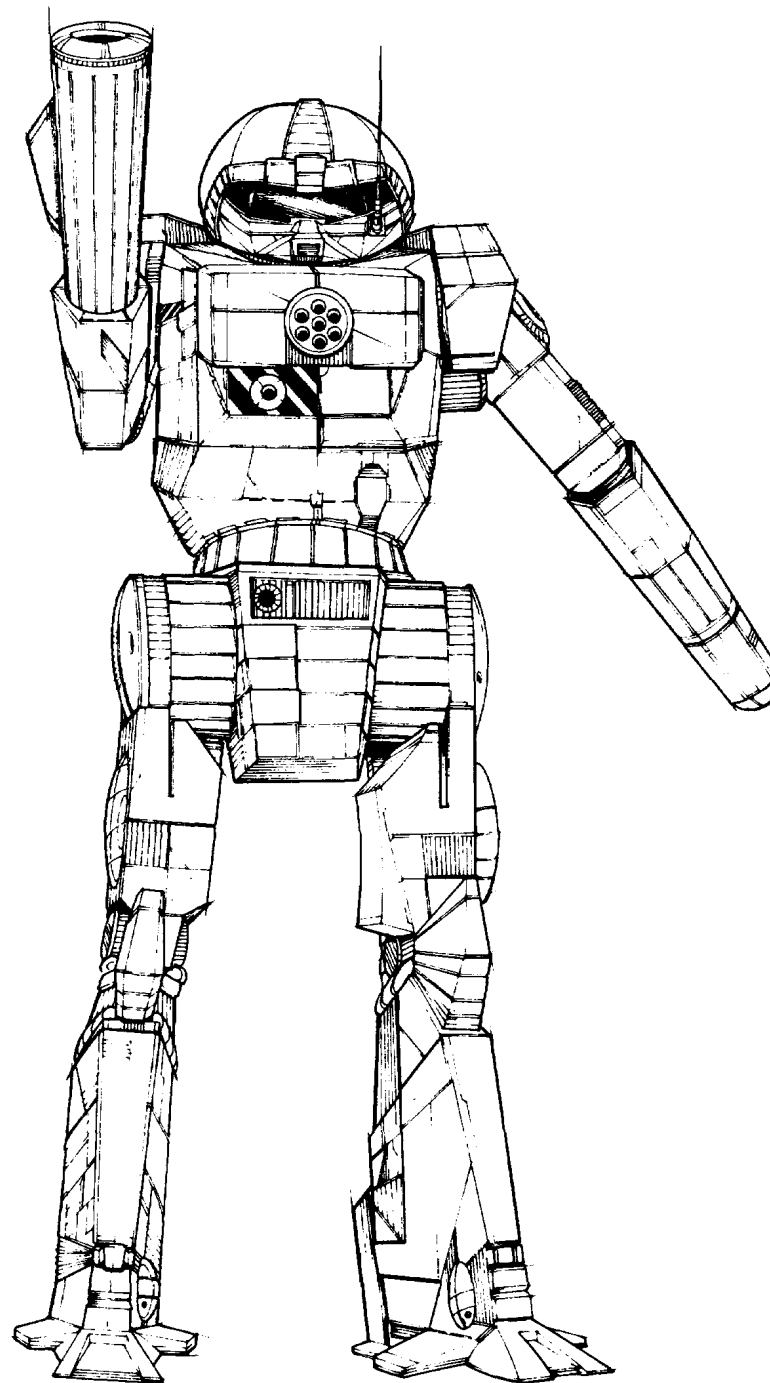

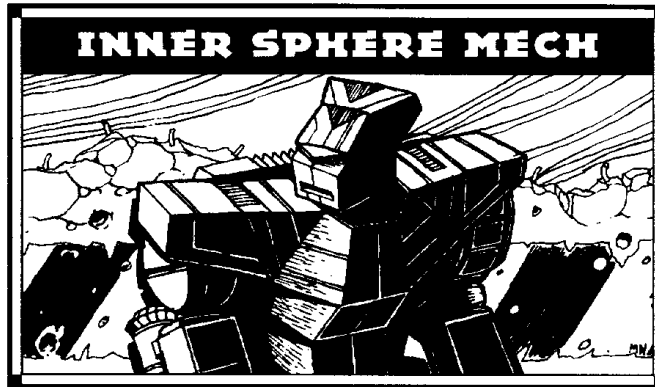

OVERVIEW

Kali Yama's original *Hunchback* was renowned for its devastating firepower at close ranges, but the design's rapid heat buildup often hampered its battlefield effectiveness. In response to this flaw, the Kalidasa-based manufacturer fitted the *Hunchback* with Star League-tech double heat sinks, which effectively solved the problem.

Kalidasa didn't stop there, however. In addition to double heat sinks, the manufacturer also provided the new HBK-5M *Hunchback* with a Sunglow Prism-Optic small pulse laser in place of the original version's Diverse Optics Type 10 small laser, as well as Cellular Ammunition-Storage Equipment to reduce the danger of internal ammunition explosion. Although this modification reduces the amount of autocannon ammunition the *Hunchback* can carry, most MechWarriors believe that the greater safety provided by the CASE far outweighs this cost.

Marik units that have received the renovated *Hunchback* have given it rave reviews.

HBK-5M HUNCHBACK

MEDIUM 'MECHS 113

Mass: 50 tons
Chassis: Crucis Type V
Power Plant: Nissan 200
Cruising Speed: 43.9 kph
Maximum Speed: 63.5 kph
Jump Jets: None
Jump Capacity: None
Armor: Durallex Tensile-4 with CASE
Armament:
 1 Kali Yama Big Bore Autocannon
 2 Hellion-V Medium Lasers
 1 Sunglow Prism-Optic Small Pulse Laser
Manufacturer: Kali Yama Weapons Industries Inc.
Primary Factory: Kalidasa
Communications System: Omicron 4002 Networking Channel
Targeting and Tracking System: TRSS Eagle Eye

Type: **Hunchback**
 Technology Base: Inner Sphere
 Tonnage: 50

Equipment		Mass
Internal Structure:		5
Engine:	200	8.5
Walking MP:	4	
Running MP:	6	
Jumping MP:	0	
Heat Sinks:	13 [26]	3
Gyro:		2
Cockpit:		3
Armor Factor:	160	10
	<i>Internal Structure</i>	<i>Armor Value</i>
Head	3	9
Center Torso	16	26
Center Torso (rear)		5
R/L Torso	12	20
R/L Torso (rear)		4
R/L Arm	8	16
R/L Leg	12	20

Weapons and Ammo	Location	Critical	Tonnage
AC/20	RT	10	14
Ammo (AC) 5	LT	1	1
CASE	LT	1	.5
Medium Laser	RA	1	1
Medium Laser	LA	1	1
Small Pulse Laser	H	1	1

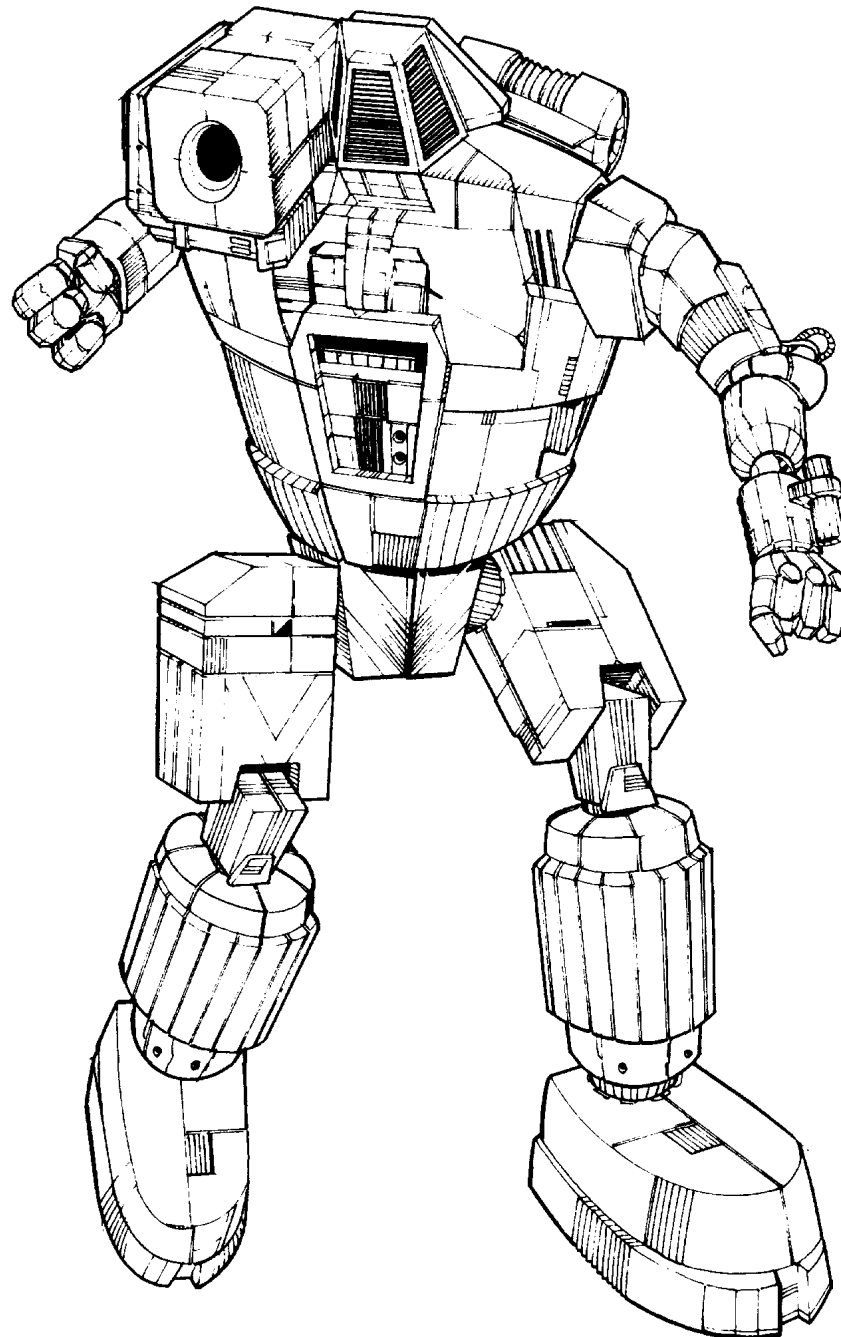



OVERVIEW

The Free Worlds League's TBT-7M *Trebuchet* is a versatile main-line medium 'Mech renowned for its long- and short-range striking power. The *Trebuchet*'s Octagon Missile-Magnet narc beacon enables a *Trebuchet* pilot to fire the machine's twin Zeus LRM-15s with pinpoint accuracy, which often allows a *Trebuchet* to severely damage opponents before they can close to effective fighting ranges. Additionally, the Octagon system enables a *Trebuchet* to share targeting information with other similarly equipped BattleMechs. Many 'Mech commanders prize the *Trebuchet* for its long-range hitting power and often deploy *Trebuchets* in support of heavy 'Mechs, such as *Marauders* and *BattleMasters*, that lack long-range weapons.

The *Trebuchet*'s three Magna Mark II medium lasers, which can inflict considerable damage within a 90-meter range, make the 'Mech design equally well suited for close-range support duties. And the *Trebuchet*'s ten double heat sinks enable it to fire its lasers continuously while moving without overheating.

Unlike earlier versions of the *Trebuchet*, the TBT-7M also features a Hermes 250 XL extra-light power plant, Corean-II Deluxe endo steel internal structure, five Rawlings 50 jump jets, and Cellular Ammunition-Storage Equipment. These features provide the *Trebuchet* with notably improved mobility, jump capability and durability—all of which makes the versatile design even more effective on the battlefield.

TBT-7M TREBUCHET

MEDIUM 'MECHS 115

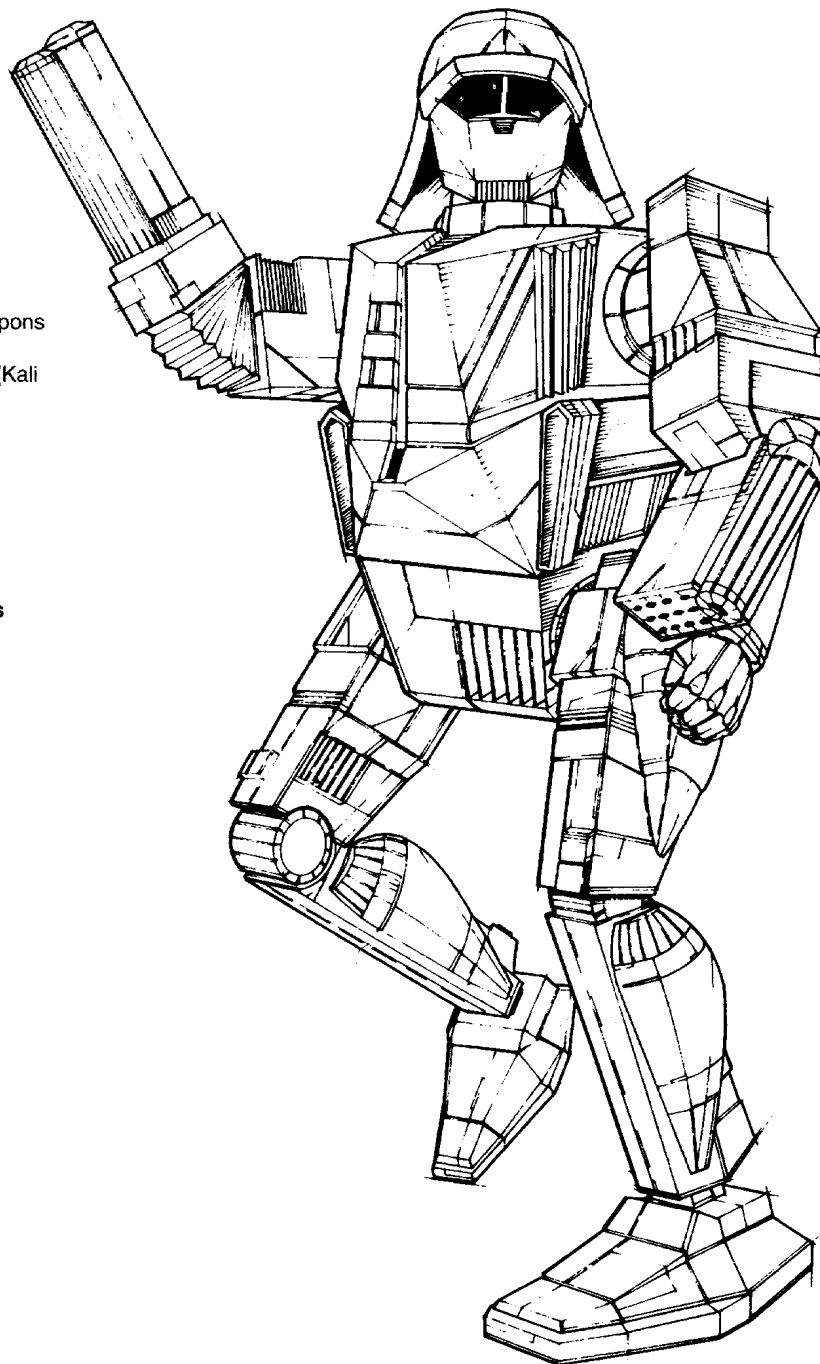

Mass: 50 tons
Chassis: Corean-II Deluxe Endo Steel
Power Plant: Magna 250 XL
Cruising Speed: 54 kph
Maximum Speed: 86.4 kph
Jump Jets: Rawlings 50
Jump Capacity: 150 meters
Armor: Starshield with CASE
Armament:
 2 Zeus LRM-15 Racks
 1 Octagon Missile-Magnet Narc Beacon
 3 Magna Mark II Medium Lasers
Manufacturer: Corean Enterprises, Kali Yama Weapons Industries Inc., Irian BattleMechs Unlimited
Primary Factory: Stewart (Corean), Kalidasa (Kali Yama), Irian (Irian)
Communications System: Corean TransBand-J9
Targeting and Tracking System: Corean B-Tech

Type: **Trebuchet**
 Technology Base: Inner Sphere
 Tonnage: 50

Equipment		Mass
Internal Structure:	Endo	2.5
Engine:	250 XL	6.5
Walking MP:	5	
Running MP:	8	
Jumping MP:	5	
Heat Sinks:	10 [20]	0
Gyro:		3
Cockpit:		3
Armor Factor:	120	7.5

	Internal Structure	Armor Value
Head	3	9
Center Torso	16	22
Center Torso (rear)		7
R/L Torso	12	11
R/L Torso (rear)		5
R/L Arm	8	10
R/L Leg	12	15

Weapons and Ammo	Location	Critical	Tonnage
LRM 15	RT	3	7
Ammo (LRM) 8	RT	1	1
CASE	RT	1	.5
LRM 15	LA	3	7
Ammo (LRM) 8	LT	1	1
CASE	LT	1	.5
Narc Missile Beacon	LT	2	3
Ammo (Narc) 12	LT	2	2
Medium Laser	RA	1	1
Medium Laser	RA	1	1
Medium Laser	LA	1	1
Jump Jet	CT	1	.5
Jump Jets	LL	2	1
Jump Jets	RL	2	1



OVERVIEW

Commonly known as the “poor man’s *Archer*,” the *Dervish* was the last ‘Mech design produced in large numbers by the Star League. Although battle losses and a lack of easily available spare parts have made the fire-support ‘Mech an increasingly uncommon sight in recent years, Achernar BattleMechs on New Avalon continues to produce new *Dervishes* for House Davion.

The most recent version of the *Dervish*, the DV-7D, contains several noteworthy features of earlier *Dervish* models, as well as a few innovations. The DV-7D continues to utilize the embedded torso-mount configuration for its twin Federated 10-Shot LRM racks, an arrangement that provides the racks with excellent protection from enemy fire. Another *Dervish* design trademark, hand-mounted SRM racks, is continued with the DV-7D’s new twin Federated SuperStreak Dual-SRM launchers; the hand-mount arrangement enables a *Dervish* pilot to aim the ‘Mech’s SRM racks without turning the machine’s torso.

The DV-7D’s endo-steel Dorwinion Standard 55TES internal structure, ferro-fibrous StarGuard CIV armor, and Cellular Ammunition-Storage Equipment represent the most notable innovations incorporated in the updated *Dervish*. The DV-7D’s new endo-steel skeleton provides the ‘Mech with structural strength superior to that of earlier *Dervishes*, and the new ferro-fibrous armor provides a noticeable improvement over the mediocre armor protection of earlier versions.

DV-7D DERVISH

MEDIUM 'MECHS 117

Mass: 55 tons
Chassis: Dorwinion Standard 55TES
Power Plant: Core Tek 275
Cruising Speed: 54 kph
Maximum Speed: 86.4 kph
Jump Jets: Swingline X-1000
Jump Capacity: 150 meters
Armor: StarGuard CIV Ferro-Fibrous with CASE
Armament:

2 Federated LRM-10 Missile Racks
 2 ChisComp 39 Medium Lasers
 2 Federated SuperStreak SRM-2 Missile Racks

Manufacturer: Achernar BattleMechs

Primary Factory: New Avalon

Communications System: Achernar Electronics HID-21

Targeting and Tracking System: Federated Hunter Mark II

Type: **Dervish**
 Technology Base: Inner Sphere
 Tonnage: 55

Equipment		Mass
Internal Structure:	Endo	3
Engine:	275	15.5
Walking MP:	5	
Running MP:	8	
Jumping MP:	5	
Heat Sinks:	10 [20]	0
Gyro:		3
Cockpit:		3
Armor Factor:	143	8
	<i>Internal Structure</i>	<i>Armor Value</i>
Head	3	9
Center Torso	18	21
Center Torso (rear)		5
R/L Torso	13	19
R/L Torso (rear)		5
R/L Arm	9	13
R/L Leg	13	17

Weapons and Ammo	Location	Critical	Tonnage
LRM 10	RT	2	5
Ammo (LRM) 12	RT	1	1
CASE	RT	1	.5
LRM 10	LT	2	5
Ammo (LRM) 12	LT	1	1
CASE	LT	1	.5
Medium Laser	RA	1	1
Medium Laser	LA	1	1

Weapons and Ammo	Location	Critical	Tonnage
Streak SRM 2	RA	1	1.5
Streak SRM 2	LA	1	1.5
Ammo (Streak) 100	RT	2	2
Jump Jet	CT	1	.5
Jump Jets	RL	2	1
Jump Jets	LL	2	1

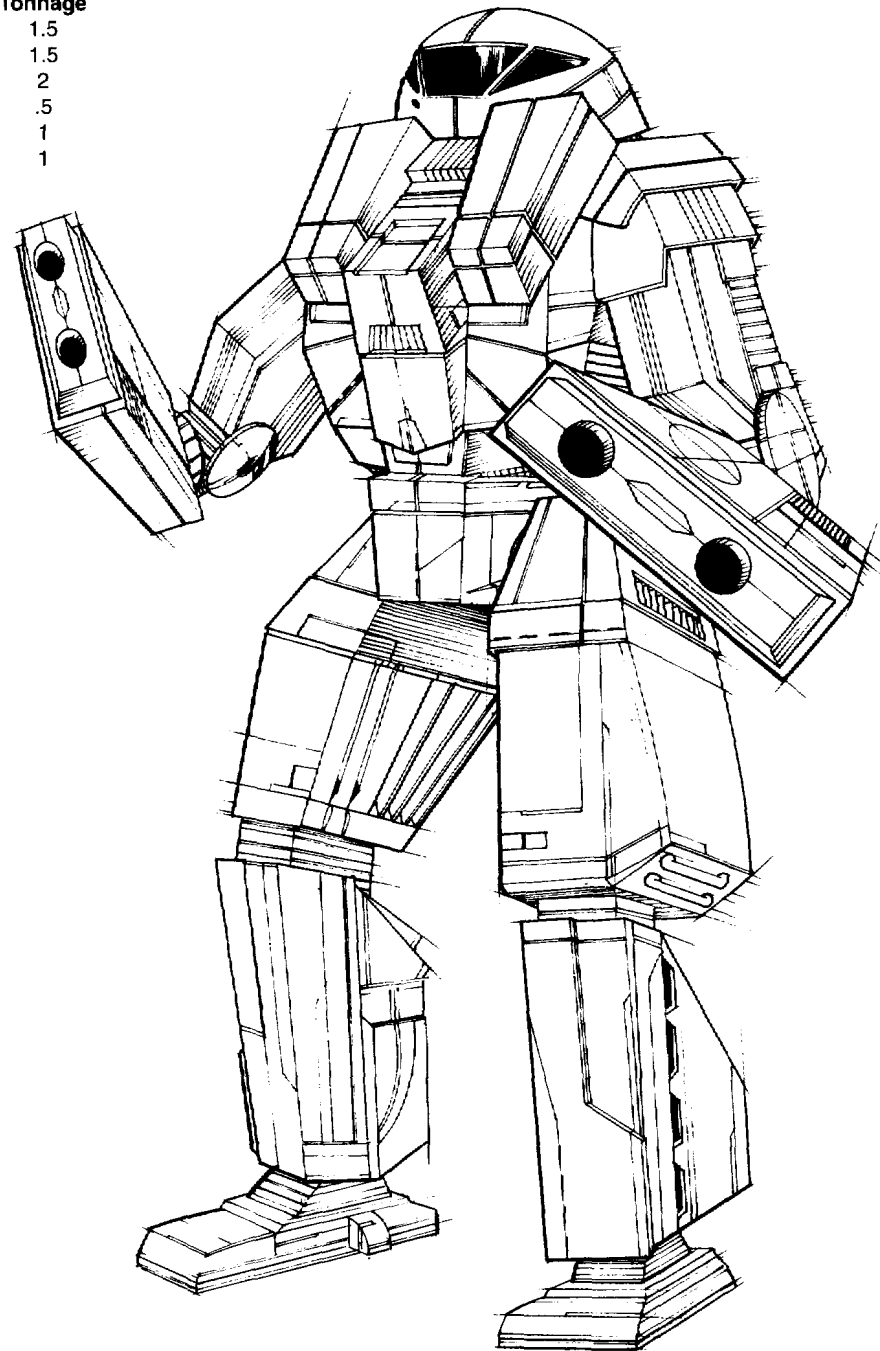



OVERVIEW

For decades, military analysts believed that the Star-League-designed *Hoplite* had been lost until several examples of the machine were observed in service with Wolf's Dragoons. The 55-ton *Hoplite* is known as a rugged, reliable BattleMech with low maintenance requirements and a solid battle record against comparable designs such as the *Griffin* and the *Wolverine*. The latest incarnation of the *Hoplite*, the HOP-4D, features 11.5 tons of DuraShield 12-b.1 armor, an arm-mounted Conan/5 LRM rack and a torso-mounted Mydron Excel LB 10-X autocannon, an innovation that provides the *Hoplite* with improved range and hitting power. Additionally, the HOP-4D carries two tons of autocannon ammunition—twice the load of the earlier HOP-4C *Hoplite*—and a full ton of reloads for its Conan/5 LRM rack.

Mass: 55 tons
Chassis: Star League HO-01a
Power Plant: DAV 220
Cruising Speed: 43 kph
Maximum Speed: 65 kph
Jump Jets: None
Jump Capacity: None
Armor: DuraShield 12-b.1
Armament:
 1 Mydron Excel LB 10-X Autocannon
 1 Conan/5 LRM 5
Manufacturer: Unknown
Primary Factory: Unknown
Communications System: MultiGab 2000
Targeting and Tracking System: Dalban HiRez II

Type: Hoplite
Technology Base: Inner Sphere
Tonnage: 55

Equipment		Mass
Internal Structure:		5.5
Engine:	220	10
Walking MP:	4	
Running MP:	6	
Jumping MP:	0	
Heat Sinks:	16	6
Gyro:		3
Cockpit:		3
Armor Factor:	184	11.5

	Internal Structure	Armor Value
Head	3	9
Center Torso	18	26
Center Torso (rear)		9
R/L Torso	13	18
R/L Torso (rear)		8
R/L Arm	9	18
R/L Leg	13	26

Weapons and Ammo	Location	Critical	Tonnage
LB 10-X AC	RA	6	11
Ammo (LB-X) 20	RT	2	2
LRM 5	LA	1	2
Ammo (LRM) 24	CT	1	1

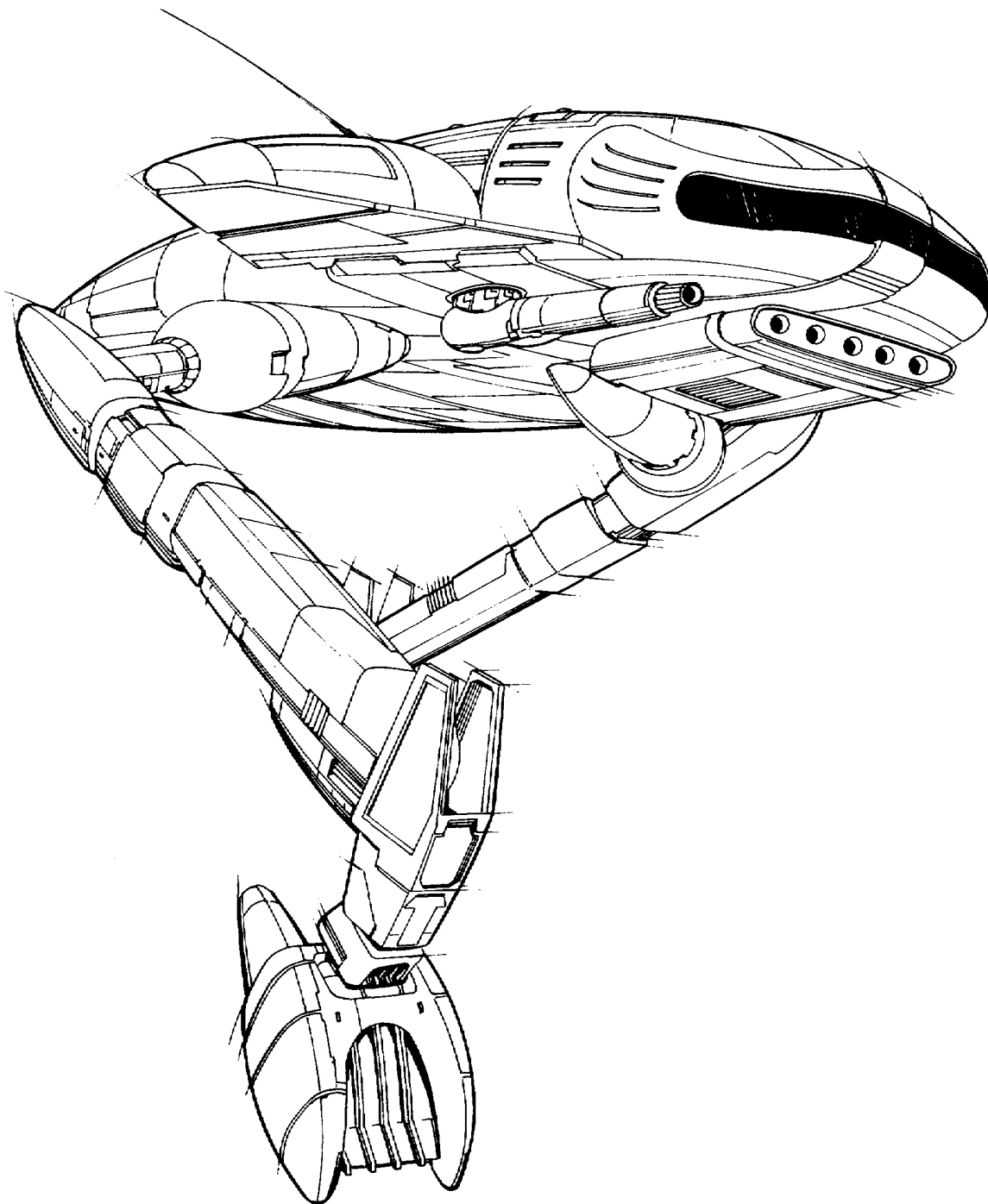

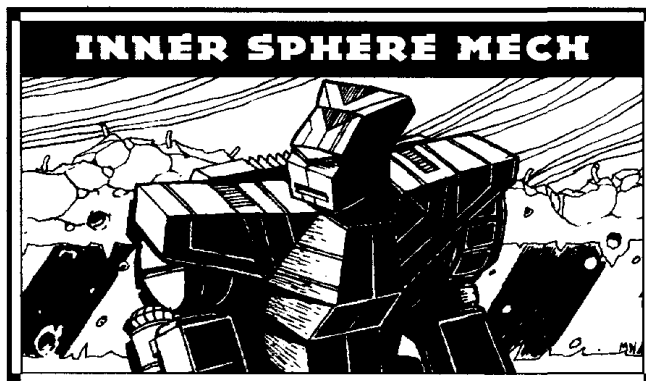

OVERVIEW

The Draconis Combine has used the *Kintaro* to great effect ever since Primus Myndo Waterly gave several models of the 'Mech to House Kurita in the 3030s. The Combine's rebuilt Ryuken regiments had extraordinary success with the *Kintaro* in the War of 3039, forcing the Federated Commonwealth to fight unknown units composed of 'Mechs whose capabilities were a mystery. In some cases, the effect on the enemy was devastating.

Draconis Combine *Kintaros* are virtually identical to those used by the Com Guards, lacking only the Narc missile beacon that is standard equipment on Com Guard versions. The official explanation offered by Primus Waterly for the difference—namely, that missiles equipped to pick up the Narc signal are in such short supply that the Narc beacon might be a liability in a prolonged campaign—was accepted apparently without question. It is true that House Kurita would not be able to take full advantage of the technology by equipping the *Kintaro*'s lancemates with Narc-compatible missiles, and the additional firepower provided by the large laser seems to have settled any concerns in the DCMS about the *Kintaro*'s fighting capabilities.

Mass: 55 tons
Chassis: Technicon-1
Power Plant: Core Tek 275
Cruising Speed: 54 kph
Maximum Speed: 86 kph
Jump Jets: None
Jump Capacity: None
Armor: Leopard V Ferro-Fibrous
Armament:
 1 Magna Mark III Large Laser
 1 Holly LRM-5 Missile Rack
 2 Hovertec SRM-6 Missile Racks
 2 Magna Mark II Medium Lasers
Manufacturer: General Mechanics
Primary Factory: Mars
Communications System: OmniComm 3
Targeting and Tracking System: Starbeam 3000

Type: Kintaro
Technology Base: Inner Sphere
Tonnage: 55

Equipment		Mass
Internal Structure:		5.5
Engine:	275	15.5
Walking MP:	5	
Running MP:	8	
Jumping MP:	0	
Heat Sinks:	10 [20]	0
Gyro:		3
Cockpit:		3
Armor Factor:	179	10
	<i>Internal Structure</i>	<i>Armor Value</i>
Head	3	9
Center Torso	18	26
Center Torso (rear)		10
R/L Torso	13	18
R/L Torso (rear)		8
R/L Arm	9	18
R/L Leg	13	23

Weapons and Ammo	Location	Critical	Tonnage
Large Laser	CT	2	5
LRM 5	RT	1	2
Ammo (LRM) 24	LT	1	1
SRM 6	LA	2	3
Ammo (SRM) 15	LT	1	1
SRM 6	RT	2	3
Ammo (SRM) 15	RT	1	1
Medium Laser	RA	1	1
Medium Laser	RA	1	1

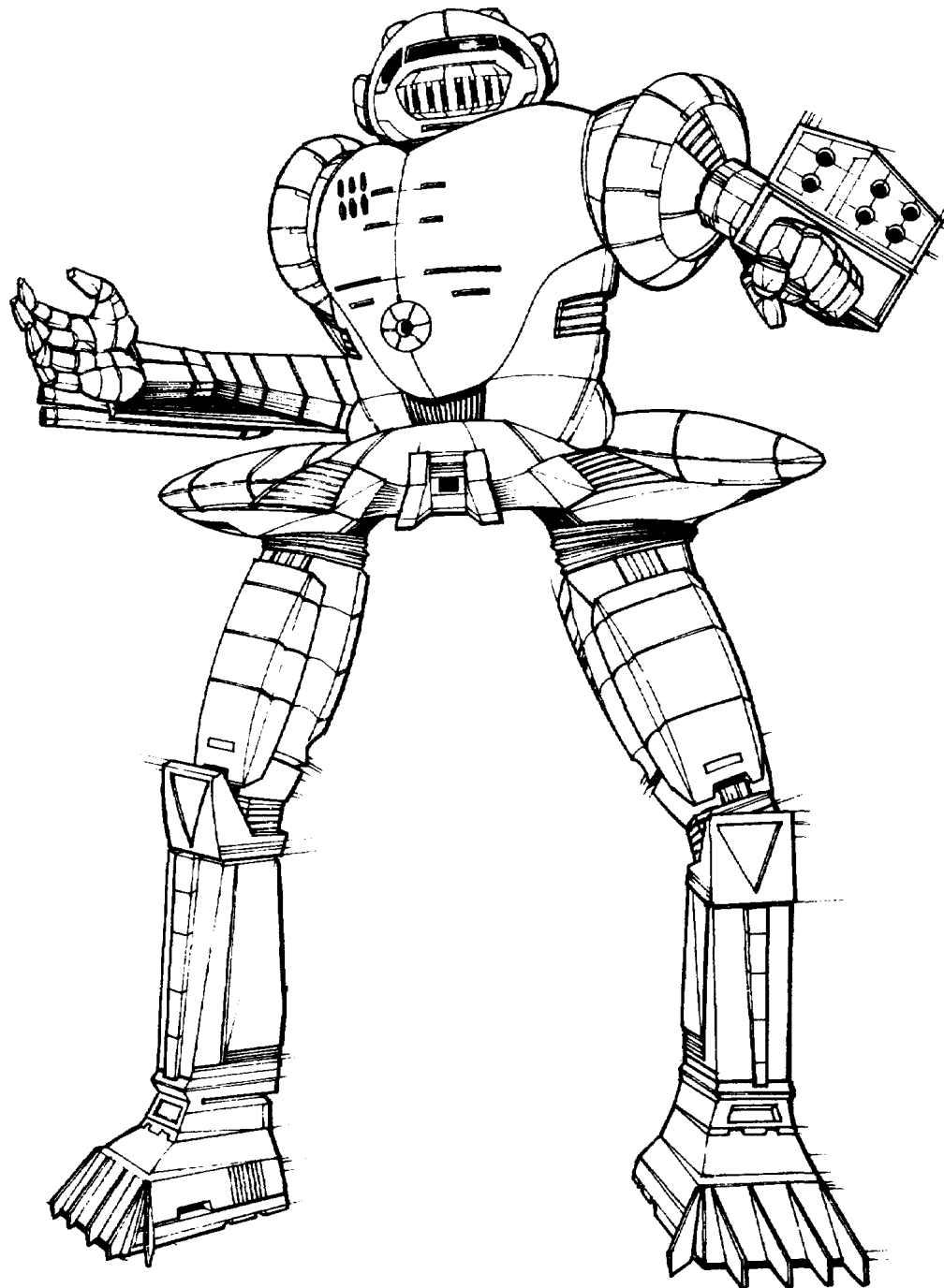

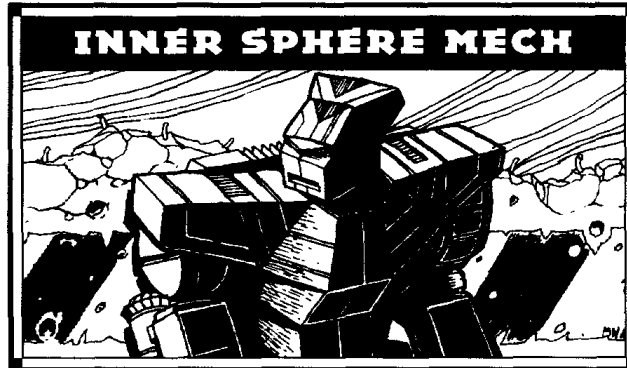

OVERVIEW

Introduced in 2602, the CHP-1N *Champion* is a fast and maneuverable heavy BattleMech with a flexible array of weapons. Weighing in at sixty tons and with a top running speed of 86.4 kph, the *Champion* was built as a heavy reconnaissance and strike BattleMech, but it also often serves with main-line units in more general combat roles.

With its Vlar 300 fusion engine alone weighing twenty tons, many criticize the vehicle as over-engined, oversized, undergunned and too costly. Thanks to its high performance level, however, the *Champion* has become popular with its pilots and the MechWarriors who serve alongside it. Even though many other BattleMechs in the *Champion's* weight class are more heavily armed and sport more protection than its two tons of Star Slab ferro-fibrous armor, few can match its speed and maneuverability and thus its higher survival rate.

The *Champion's* weapons include one Lubalin Ballistics LB 10-X autocannon, one Harpoon-6 short-range missile launcher, a pair of Magna Mark II medium lasers, and two Martell small lasers. Though it carries extra ammunition, the 'Mech sometimes must withdraw from combat early or close quickly to engage targets with its short-range missiles and lasers.

The 'Mech has been known to run hot when involved in heavy combat, thanks to the low-efficiency (and less costly) heat sinks originally installed. Many SLDF units removed these sinks and replaced them with a newer model that dissipates twice as much heat, making battle much more endurable for the pilots.

Mass: 60 tons
Chassis: Bergan XI
Power Plant: Vlar 300
Cruising Speed: 54 kph
Maximum Speed: 86 kph
Jump Jets: None
Jump Capacity: None
Armor: 2/Star Slab Ferro-Fibrous
Armament:
 1 Lubalin LB 10-X Autocannon
 1 Harpoon SRM-6 Missile Rack
 2 Magna Mark II Medium Lasers
 2 Martell Small Lasers
Manufacturer: Bergan Industries
Communications System: Garret T-11C
Targeting and Tracking System: Mercury-IV with
 Artemis IV FCS

Type: Champion
Technology Base: Inner Sphere
Tonnage: 60

Equipment		Mass
Internal Structure:		6
Engine:	300	19
Walking MP:	5	
Running MP:	8	
Jumping MP:	0	
Heat Sinks:	10	0
Gyro:		3
Cockpit:		3
Armor Factor:	143	8
	<i>Internal Structure</i>	<i>Armor Value</i>
Head	3	9
Center Torso	20	24
Center Torso (rear)		8
R/L Torso	14	18
R/L Torso (rear)		6
R/L Arm	10	12
R/L Leg	14	15

Weapons and Ammo	Location	Critical	Tonnage
LB 10-X AC	RT	6	11
Ammo (LB-X) 20	RT	2	2
SRM 6	LT	2	3
Ammo (SRM) 15	LT	1	1
Artemis IV FCS	LT	1	1
Medium Laser	LT	1	1
Medium Laser	LT	1	1
Small Laser	CT	1	.5
Small Laser	CT	1	.5

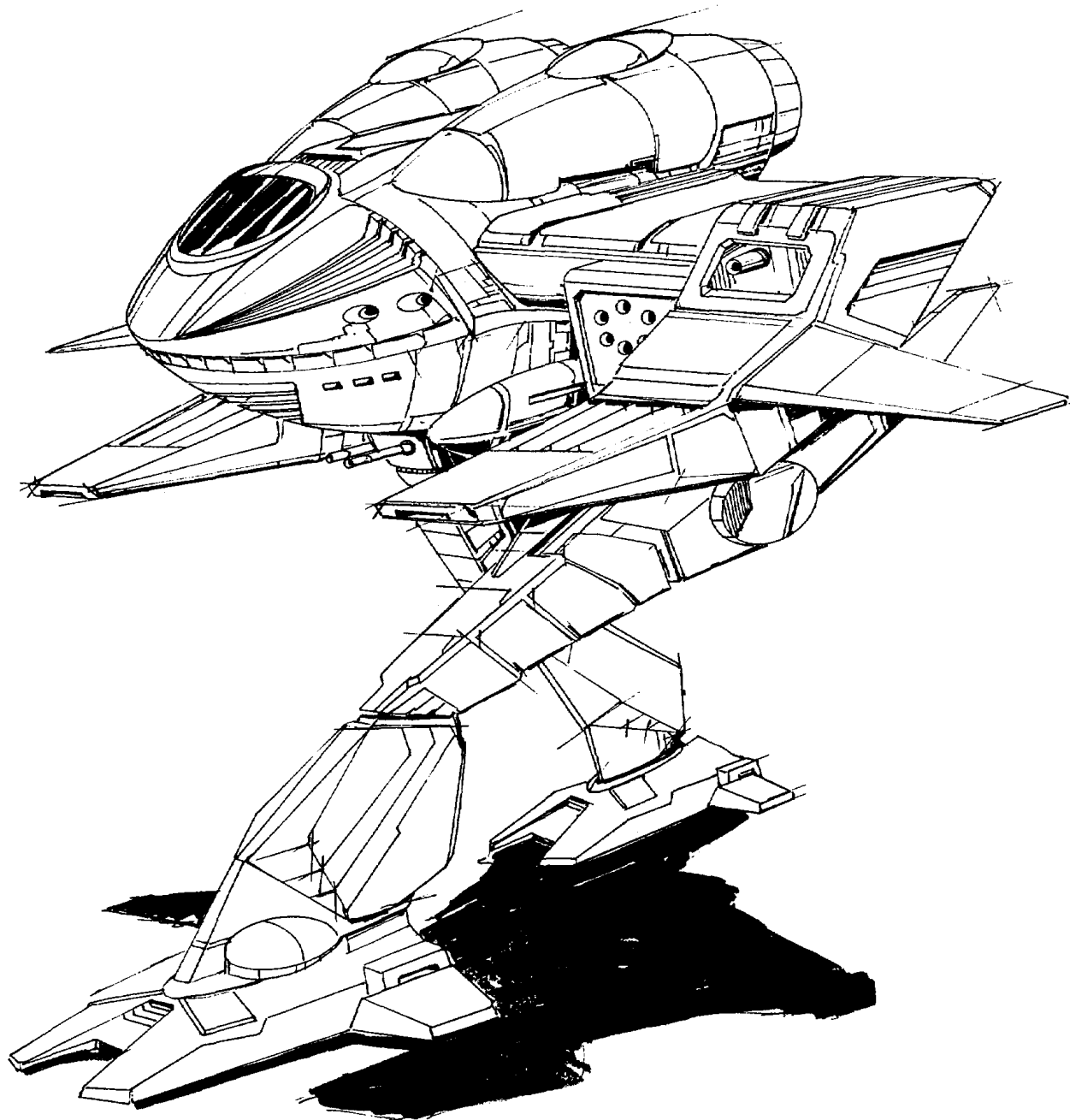



OVERVIEW

House Kurita's *Grand Dragon* is the successor to the renowned DRG-1N *Dragon* and contains the most popular features of that design, as well as several improvements. Like its predecessor, the *Grand Dragon* possesses a squat profile that presents a small target to enemy 'Mechs. And like the *Dragon*, the *Grand Dragon* boasts an ample supply of Starshield armor, which enables the 'Mech to withstand considerable punishment.

Modifications incorporated in the *Grand Dragon* include a Lord's Light 2 extended-range particle-beam weapon in place of the *Dragon*'s autocannon, a Hermes 300 XL extra-light power plant, double heat sinks, and an additional Victory 23R medium laser. These modifications provide the *Grand Dragon* with fearsome firepower and unmatched versatility and virtually ensure that the design will become a workhorse of the Draconis Combine Mustered Soldiery.

Despite the introduction of the *Grand Dragon*, House Kurita has not abandoned the earlier *Dragon* design. Large numbers of *Dragons* continue to serve with Kurita forces, and Kurita techs are currently refitting many later *Dragons* with Emperor Ultra-5 autocannons.

DRG-5K GRAND DRAGON

Mass: 60 tons
Chassis: Alshain Type 56-60H
Power Plant: Hermes 360 XL
Cruising Speed: 64.8 kph
Maximum Speed: 97.2 kph
Jump Jets: None
Jump Capacity: None
Armor: Starshield with CASE
Armament:
 1 Telos DecaCluster LRM-10 Missile Rack
 1 Lord's Light 2 Extended Range PPC
 3 Victory 23R Medium Lasers
Manufacturer: Luthien Armor Works
Primary Factory: Luthien
Communications System: Sipher CommSys 3
Targeting and Tracking System: Eagle Eye SY10-10

Type: Grand Dragon
Technology Base: Inner Sphere
Tonnage: 60

Equipment		Mass
Internal Structure:		6
Engine:	360 XL	16.5
Walking MP:	6	
Running MP:	9	
Jumping MP:	0	
Heat Sinks:	13 [26]	3
Gyro:		4
Cockpit:		3
Armor Factor:	160	10

	Internal Structure	Armor Value
Head	3	9
Center Torso	20	27
Center Torso (rear)		12
R/L Torso	14	16
R/L Torso (rear)		8
R/L Arm	10	14
R/L Leg	14	18

Weapons and Ammo	Location	Critical	Tonnage
LRM 10	CT	2	5
Ammo (LRM) 24	LT	2	2
CASE	LT	1	.5
ER PPC	RA	3	7
Medium Laser	LA	1	1
Medium Laser	LT (R)	1	1
Medium Laser	RT (R)	1	1

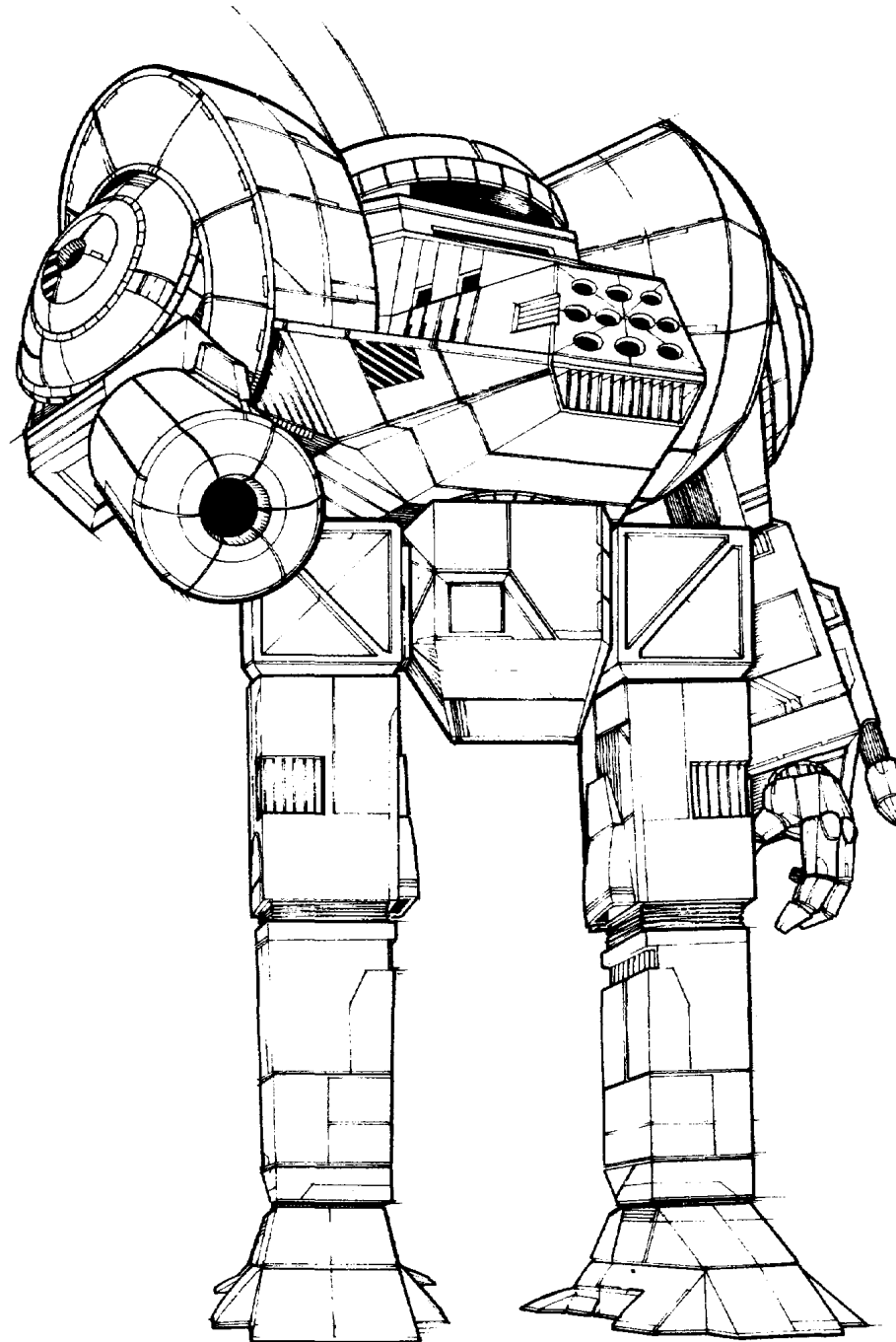



OVERVIEW

The sixty-ton *Lancelot* was built in 2581 with three specifications in mind: limited dependence on ammunition or support, enough speed for mobile operation, and sufficient firepower to be a viable combat force. The resulting 'Mech, a superior design from a number of standpoints, quickly became known as a durable and reliable fighting machine.

Equipped with the Hermes 360XL power plant, which produces extended output and endurance and weighs less than conventional fusion plants, the *Lancelot* can reach a top speed of 97 kph. Alterations in the Hermes' shielding placement and core positioning dropped tons from the power plant, allowing room for several more heat sinks in the 'Mech's center torso to give it superior heat-venting capability.

This capability comes in handy when the *Lancelot* fires its main weapons. The Kinslaughter PPC has insulation problems and generates more heat than many weapons of its type, making preventative maintenance a necessity. The 'Mech also mounts a Krupp Model 12 medium laser in its center torso, as well as one Krupp Model 32 large laser (nicknamed "Fur Burner") in each arm. The Model 32 is known for its reliable performance, especially when linked with the *Lancelot's* battle computer.

The standard Krupp KBC battle computer was modified to monitor a wider range of internal input, allowing the pilot to check on such information as current armor status and skin temperature without inhibiting the BattleMech's abilities in a fighting environment.

The *Lancelot's* Krupp KBC Starsight Model 3 targeting and tracking system can single out enemy 'Mechs targeting it and instantly identify the most serious threat, highlighting it for immediate attention. This gives the *Lancelot* a major advantage in a large-scale battle, where hundreds of projectiles can shoot through the air in just a few seconds. To give the 'Mech a narrower silhouette for enemies to target, designers added PanzerSlab armor plates to critical locations and arranged them in subtle curves.

Used mainly against infantry, the LNC25-05 variant of the *Lancelot* has only ten heat sinks and replaces the medium laser with Krupp Model 3 mini-guns.

LNC25-01 LANCELOT

Mass: 60 tons
Chassis: MangoTech 500 SJ (Spiral Jection)
Power Plant: Hermes 360 XL
Cruising Speed: 65 kph
Maximum Speed: 97 kph
Jump Jets: None
Jump Capacity: None
Armor: PanzerSlab Type 5
Armament:
 1 Kinslaughter PPC
 2 Krupp Model 32 Large Lasers
 1 Krupp Model 2 Medium Laser
Manufacturer: Krupp Stellar Technologies Inc.
Communications System: Krupp-COMM 500
Targeting and Tracking System: KBC Starsight Model 3

Type: **Lancelot**
 Technology Base: Inner Sphere
 Tonnage: 60

Equipment		Mass
Internal Structure:		6
Engine:	360 XL	16.5
Walking MP:	6	
Running MP:	9	
Jumping MP:	0	
Heat Sinks:	13 [26]	3
Gyro:		4
Cockpit:		3
Armor Factor:	152	9.5

	Internal Structure	Armor Value
Head	3	7
Center Torso	20	21
Center Torso (rear)		16
R/L Torso	14	16
R/L Torso (rear)		10
R/L Arm	10	14
R/L Leg	14	14

Weapons and Ammo	Location	Critical	Tonnage
PPC	RT	3	7
Large Laser	RA	2	5
Large Laser	LA	2	5
Medium Laser	CT	1	1

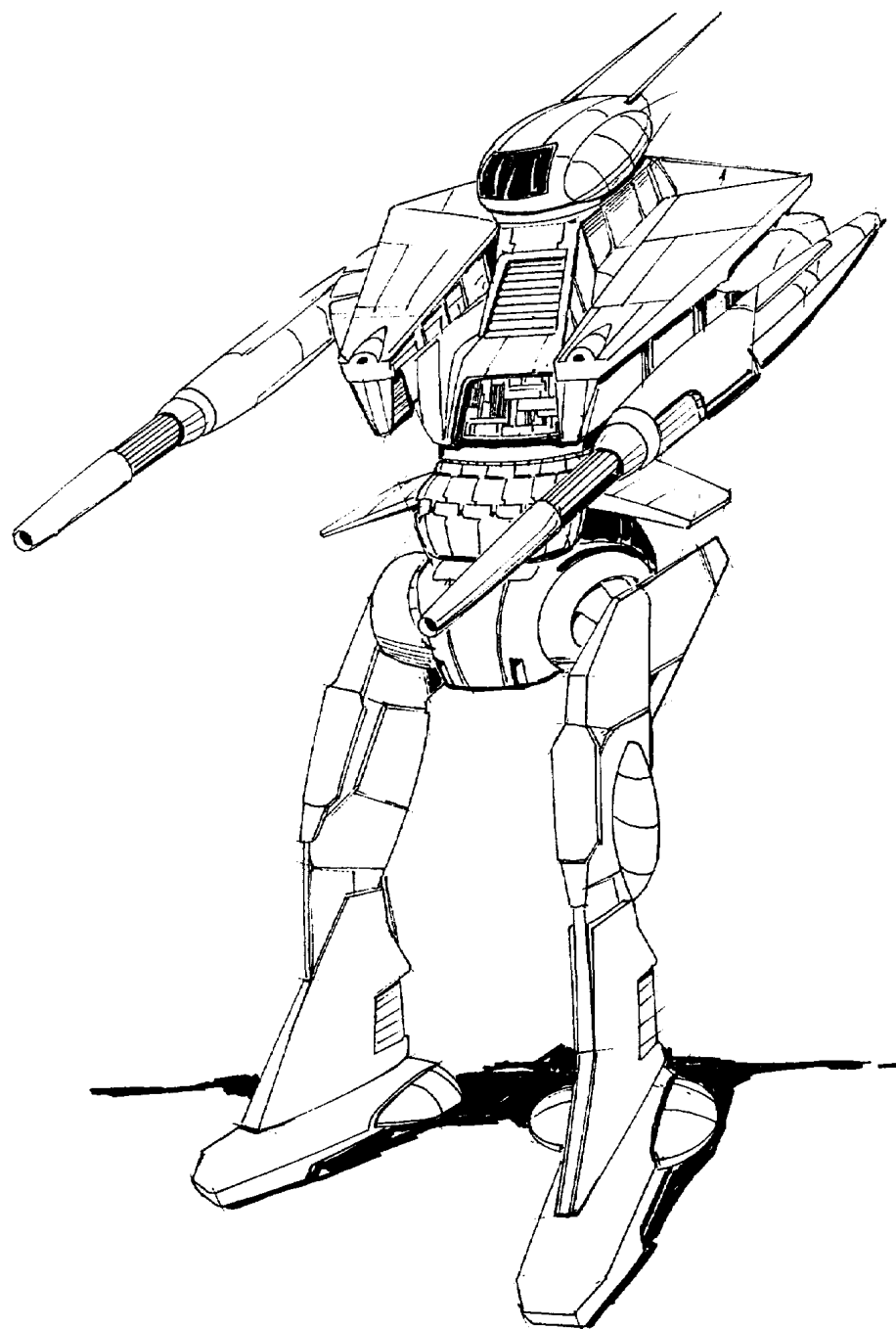



OVERVIEW

Technicon Manufacturing's QKD-5M *Quickdraw* contains several new features designed to increase the effectiveness of this fast and maneuverable heavy BattleMech design. Like most other recent House Marik 'Mech updates, the new *Quickdraw* features an extra-light engine and improved armor—in this case the Magna 300 and Kallon FWL Special ferro-fibrous. The Magna 300 provides the *Quickdraw* with a top speed of 86.4 kph—a 30-percent increase over the top speed of the QKD-4G *Quickdraw*, while the new armor provides 12 percent more armor protection than the QKD-4G's Riese-475. Additionally, the new *Quickdraw* is fitted with double heat sinks and Cellular Ammunition-Storage Equipment to guard against overheating and internal ammunition explosions.

The QKD-5M retains the torso-mounted Delta Dart LRM rack featured in earlier versions of the 'Mech, as well as the four torso- and arm-mounted Omicron 4000 medium lasers. Additionally, the new *Quickdraw* features a torso-mounted Hovertec detachable SRM-4 launcher. The Hovertec quad system is a one-shot weapon normally used only on helicopters, hovercraft and other vehicles designed make single offensive passes at targets. Although the one-shot system severely reduces the *Quickdraw's* overall short-range firepower, it also eliminates the need to carry SRM ammo and therefore reduces the risk of internal ammo explosions.

Another update of the *Quickdraw*, Luthien Armor Works' QKD-5K, replaces the QKD-4G's LRM launchers with two additional medium lasers and 17 double heat sinks.

QKD-5M QUICKDRAW

Mass: 60 tons
Chassis: Technicon Type E
Power Plant: Vlar 300
Cruising Speed: 54 kph
Maximum Speed: 86.4 kph
Jump Jets: Chilton 460
Jump Capacity: 150 meters
Armor: Kallon FWL Special Ferro-Fibrous with CASE
Armament:
 1 Delta Dart LRM-10 Missile Rack
 1 Hovertec SRM-4 Detachable Missile Rack
 4 Omicron 4000 Medium Lasers
Manufacturer: Technicon Manufacturing
Primary Factory: Savannah
Communications System: Garret T12E
Targeting and Tracking System: Dynatec 2180

Type: **Quickdraw**
 Technology Base: Inner Sphere
 Tonnage: 60

Equipment		Mass
Internal Structure:		6
Engine:	300	19
Walking MP:	5	
Running MP:	8	
Jumping MP:	5	
Heat Sinks:	13 [26]	3
Gyro:		3
Cockpit:		3
Armor Factor:	143	8
	<i>Internal Structure</i>	<i>Armor Value</i>
Head	3	9
Center Torso	20	18
Center Torso (rear)		8
R/L Torso	14	17
R/L Torso (rear)		8
R/L Arm	10	13
R/L Leg	14	16

Weapons and Ammo	Location	Critical	Tonnage
LRM 10	LT	2	5
Ammo (LRM) 12	LT	1	1
CASE	LT	1	.5
SRM 4 (OS)	CT	1	2.5
Medium Laser	LA	1	1
Medium Laser	RA	1	1
Medium Laser	RT (R)	1	1
Medium Laser	RT (R)	1	1
Jump Jet	CT	1	1
Jump Jets	LT	2	2
Jump Jets	RT	2	2

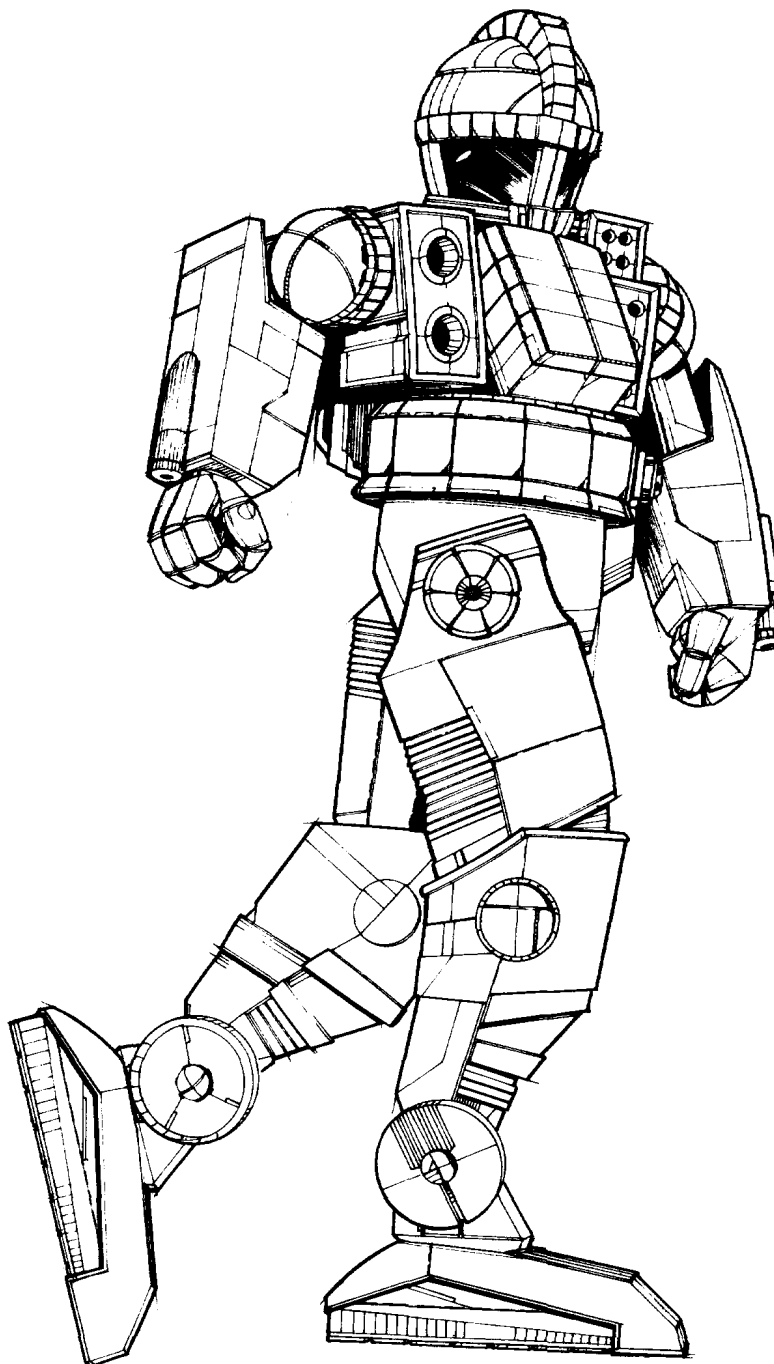



OVERVIEW

Banzai Weapon Design's AXM-1N *Axman*, manufactured at Johnston Industries' New Syrtis plant, combines devastating firepower, excellent armor protection and good maneuverability in a single BattleMech design. Intended for widespread deployment throughout the Federated Commonwealth, the *Axman* contains weapons and equipment from throughout Davion and Steiner space, as well as the Sarna March and the St. Ives Compact. Officially, this approach reflects an attempt by Banzai's designers to create a BattleMech that all of the Federated Commonwealth's MechWarriors can point to with pride, no matter what their regional loyalty—although some cynical observers believe the *Axman*'s designers are simply attempting to generate ample Federated Commonwealth contracts for the design by providing manufacturing work to numerous firms.

Regardless of their intentions, Banzai's designers have created a superior 'Mech. Equipped with ten tons of Kallon Unity Weave ferro-fibrous armor from a former Liao factory in the Sarna March and four HildCo Model 12 jump jets from the St. Ives Compact, the *Axman* possesses ample armor protection and maneuverability. And the *Axman*'s Luxor Devastator-20 autocannon, Sutel Precision large pulse laser and three Intek medium lasers give the machine truly awesome firepower. Additionally, the *Axman*'s signature arm-mounted hatchet provides the 'Mech with an intimidating and effective close-range weapon.

Mass: 65 tons
Chassis: Dorwinion Standard
Power Plant: Magna 260 XL
Cruising Speed: 43.2 kph
Maximum Speed: 64.8 kph
Jump Jets: HlidCo Model 12
Jump Capacity: 120 meters
Armor: Kallon Unity Weave Ferro-Fibrous with CASE
Armament:
 1 Luxor Devastator-20 Autocannon
 3 Intek Medium Lasers
 1 Sutel Precision Line Large Pulse Laser
Manufacturer: Johnston Industries
Primary Factory: New Syrtis
Communications System: Johnston Wide Band
Targeting and Tracking System: Rander Pinpoint-HY

Type: **Axman**
 Technology Base: Inner Sphere
 Tonnage: 65

Equipment		Mass
Internal Structure:		6.5
Engine:	260 XL	7
Walking MP:	4	
Running MP:	6	
Jumping MP:	4	
Heat Sinks:	10 [20]	0
Gyro:		3
Cockpit:		3
Armor Factor:	179	10
	<i>Internal Structure</i>	<i>Armor Value</i>
Head	3	9
Center Torso	21	28
Center Torso (rear)		6
R/L Torso	15	21
R/L Torso (rear)		6
R/L Arm	10	17
R/L Leg	15	24

Weapons and Ammo	Location	Critical	Tonnage
AC/20	RT/CT	10	14
Ammo (AC) 10	LT	2	2
CASE	LT	1	.5
Medium Laser	RA	1	1
Medium Laser	RA	1	1
Medium Laser	RA	1	1
Large Pulse Laser	LA	2	7
Hatchet	RA	5	5
Jump Jets	RL	2	2
Jump Jets	LL	2	2

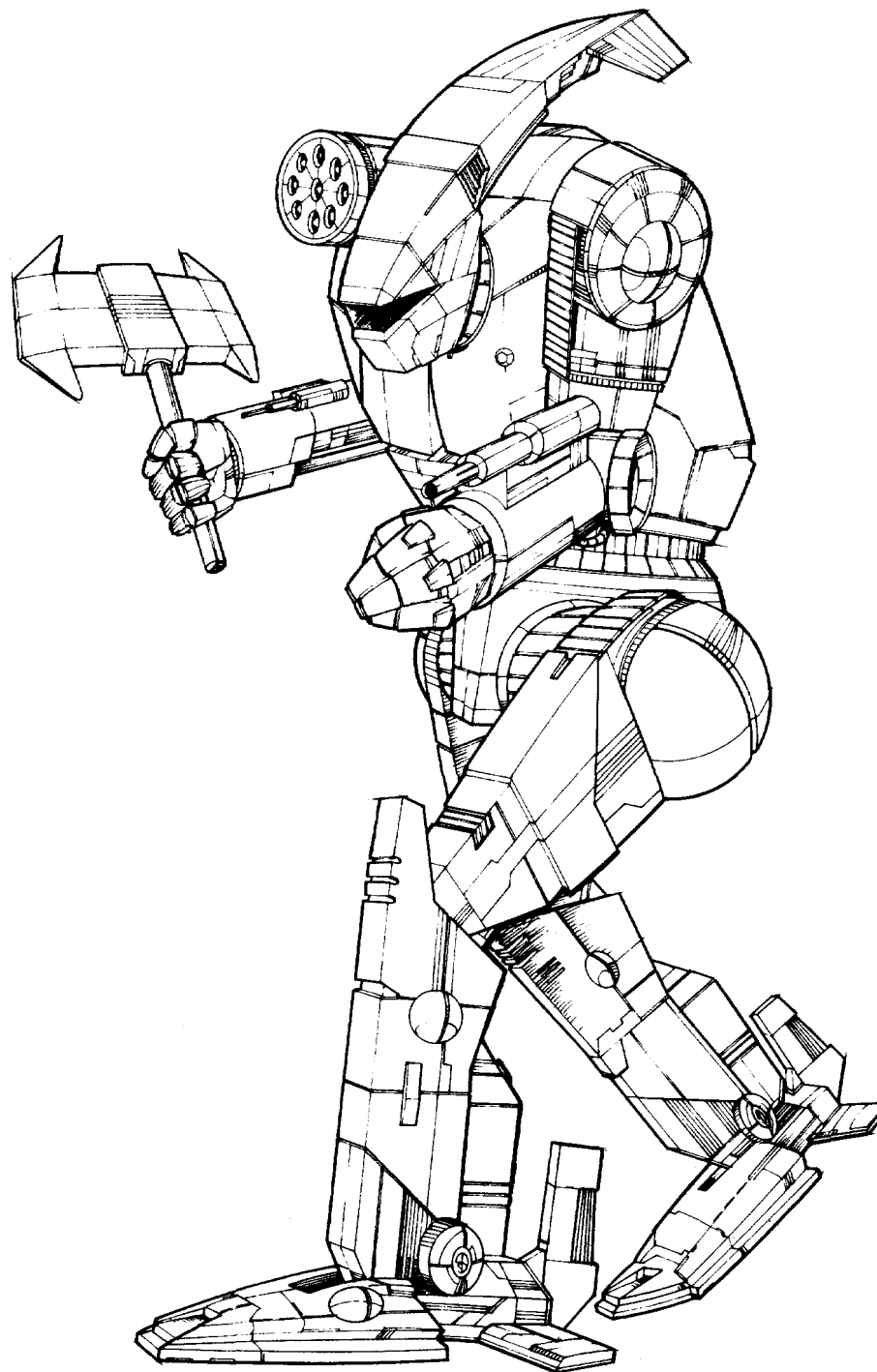



OVERVIEW

The *Bombardier* was designed in 2735 to replace mechanized mobile units, such as wheeled or tracked artillery vehicles, for rear-area artillery support. Weighing in at sixty-five tons with a maximum speed of 86 kph, the 'Mech is faster and more heavily armored than mechanized mobile units, and passed every test and field exercise with honors.

In its assigned role, the BMB-12D *Bombardier* is very efficient. Its VOX 325XL power plant keeps it within support range of advancing 'Mechs and enables it to easily change its position to avoid counter-battery fire. It carries a substantial amount of Choutaka Armorscale and is also equipped with CASE.

The 'Mech's two Delphinus long-range missile racks are designed to launch diverse types of missiles. The Swarm missile, developed for the Delphinus, contains 100 mini-shells that separate when the missile reaches the target area. One barrage of twenty such missiles can devastate a large area. Thunder missiles, another favorite, contain 100 mines that spread out in the path of advancing BattleMechs and then detonate, crippling the legs of an attacking force. At shorter range, the Arrowlite SRMs can inflict considerable damage. The Buzzsaw anti-missile system is the *Bombardier's* only defensive armament. Designed to defend the 'Mech against counter-battery fire, it is also useful in face-to-face confrontations.

The *Bombardier's* major drawback in extended-combat situations is its rapid expenditure of specialized missiles, which can leave it nearly helpless unless replacements are readily available. *Bombardiers* are usually grouped into their own support lance and assigned to a 'Mech regiment. However, missile-supply problems frequently force them to withdraw from long-drawn out battles.

Mass: 65 tons
Chassis: KetoBond
Power Plant: VOX 325 XL
Cruising Speed: 54 kph
Maximum Speed: 86 kph
Jump Jets: None
Jump Capacity: None
Armor: Choutaka Armorscale, Ltd. with CASE
Armament:
 2 Delphinus LRM-20 Missile Racks
 1 Arrowlite SRM-4 Missile Rack
 1 Buzzsaw Anti-Missile System
Manufacturer: Wakazashi Enterprises
Communications System: Neil 9000
Targeting and Tracking System: DLK Type Phased Array Sensors

Type: **Bombardier**
 Technology Base: Inner Sphere
 Tonnage: 65

Equipment		Mass
Internal Structure:		6.5
Engine:	325 XL	12
Walking MP:	5	
Running MP:	8	
Jumping MP:	0	
Heat Sinks:	10 [20]	0
Gyro:		4
Cockpit:		3
Armor Factor:	200	12.5
	<i>Internal Structure</i>	<i>Armor Value</i>
Head	3	9
Center Torso	21	24
Center Torso (rear)		15
R/L Torso	15	20
R/L Torso (rear)		10
R/L Arm	10	20
R/L Leg	15	26

Weapons and Ammo	Location	Critical	Tonnage
LRM 20	LT	5	10
LRM 20	RT	5	10
Ammo (LRM) 12	RT	2	2
CASE	RT	1	.5
SRM 4	RA	1	2
Ammo (SRM) 25	RA	1	1
Anti-Missile System	CT	1	.5
Ammo (Anti-Missile) 12	CT	1	1

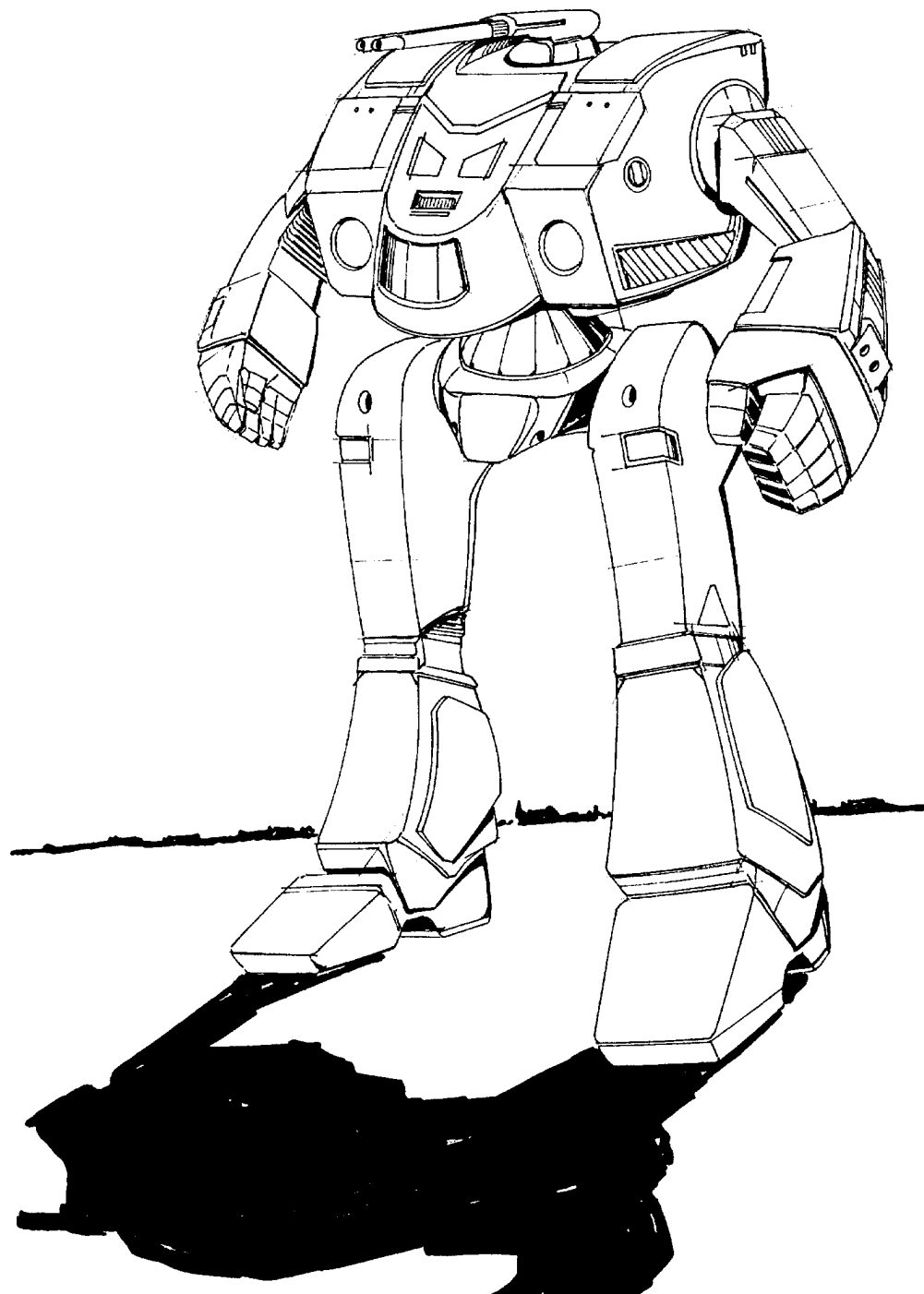

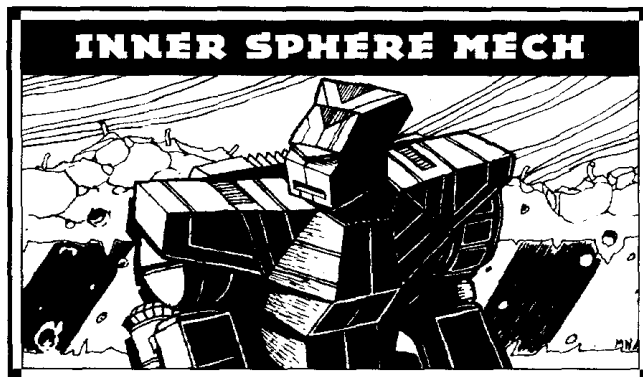

OVERVIEW

The CPLT-3 *Catapult* is a second-line fire-support 'Mech used primarily by the Capellan military. Although the design lacks the manipulative hands needed for effective close combat and possesses no infantry-defense systems, the *Catapult* can muster impressive firepower. On earlier *Catapult* machines, Holly LRM racks provided long-range striking power. The CPLT-3, however, replaces the Holly launcher with the Luxor Mobile Battery 1 Arrow IV missile system, a bulky yet powerful weapon more commonly found on heavy tanks or in fixed installations. Although the Arrow IV system does nothing to improve the *Catapult's* mobility, it does provide the 'Mech with excellent long-range striking power; missiles from the versatile system can be directed by the *Catapult's* own targeting-acquisition equipment or by targeting data from any other suitably equipped BattleMech design, such as the *Raven*. At shorter ranges, the *Catapult* can employ its four torso-mounted Martell medium lasers to devastating effect.

Mass: 65 tons
Chassis: Hollis Mark II
Power Plant: Magna 260
Cruising Speed: 43.2 kph
Maximum Speed: 64.8 kph
Jump Jets: Anderson Propulsion 21
Jump Capacity: 120 meters
Armor: Durallex Heavy

Armament:
 1 Luxor Mobile Battery
 1 Arrow IV Missile System
 4 Martell Medium Lasers

Manufacturer: Hollis Incorporated
Primary Factory: Corey
Communications System: O/P COM-211
Targeting and Tracking System: O/P 1078

Type: **Catapult**
 Technology Base: Inner Sphere
 Tonnage: 65

Equipment		Mass
Internal Structure:		6.5
Engine:	260	13.5
Walking MP:	4	
Running MP:	6	
Jumping MP:	4	
Heat Sinks:	15	5
Gyro:		3
Cockpit:		3
Armor Factor:	160	10

	Internal Structure	Armor Value
Head	3	9
Center Torso	21	24
Center Torso (rear)		11
R/L Torso	15	19
R/L Torso (rear)		8
R/L Arm	10	13
R/L Leg	15	18

Weapons and Ammo	Location	Critical	Tonnage
Arrow IV System	RT/RA	15	15
Ammo (Arrow IV) 5	RT	1	1
Medium Laser	LT	1	1
Medium Laser	RT	1	1
Medium Laser	CT	1	1
Medium Laser	CT	1	1
Jump Jets	RT	2	2
Jump Jets	LT	2	2

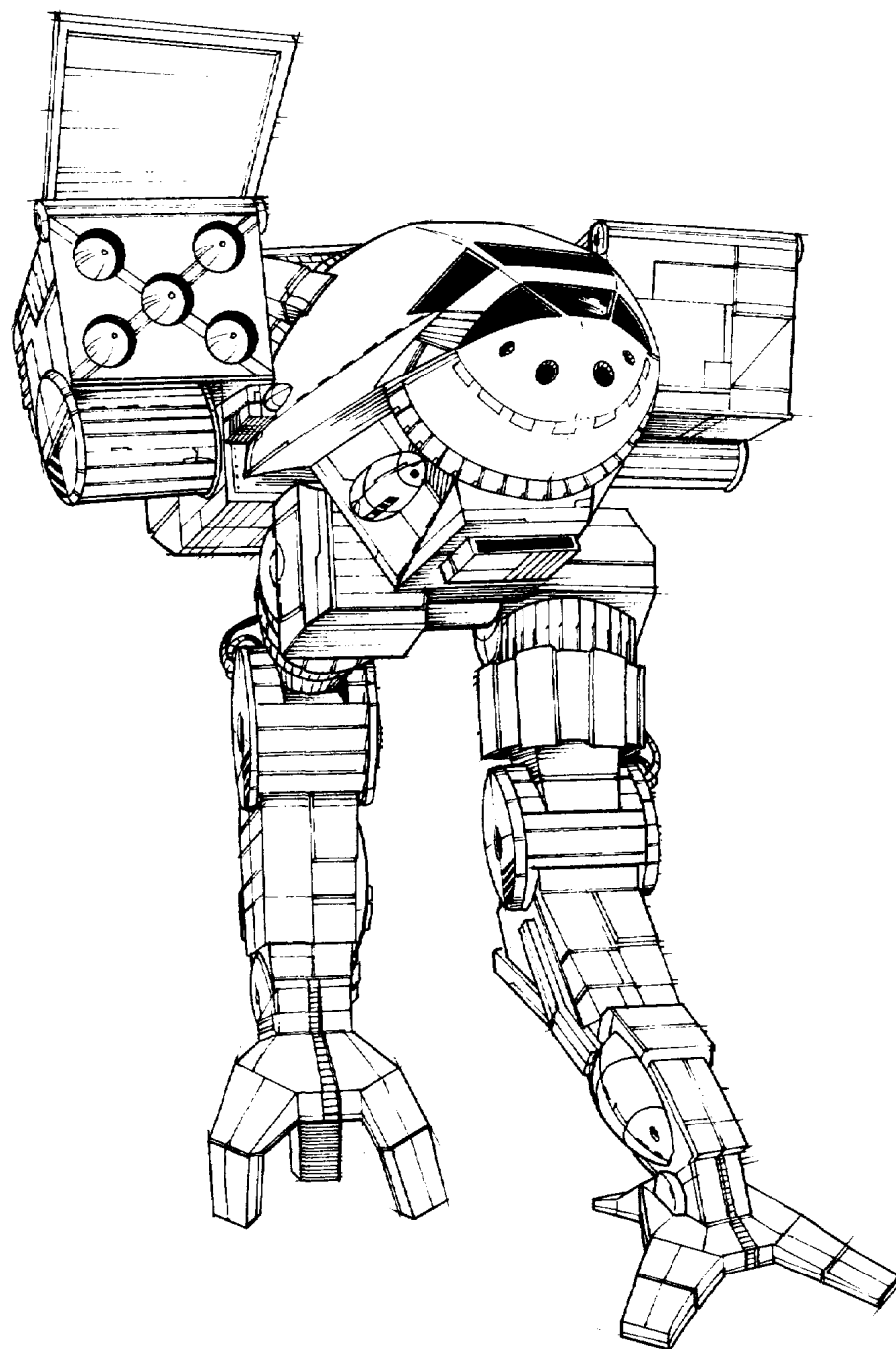

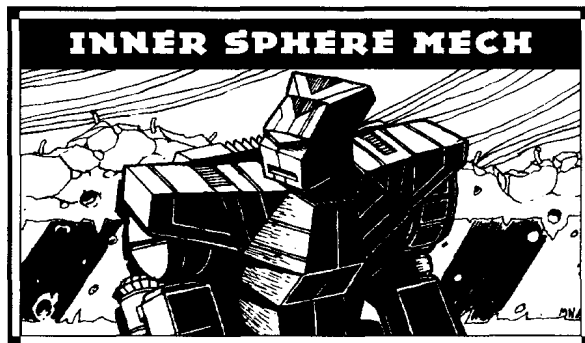

OVERVIEW

The *Exterminator* was created in 2630 for one of the most dangerous specialized missions—targeting and destroying specific command 'Mechs. To carry out this vital task, the *Exterminator* was equipped with state-of-the-art battle systems, the latest in ECM and null signature devices, and the Chameleon Light Polarization Shield—all constructed and integrated with the vehicle's single mission in mind. These 'Mechs are usually attached to high-level command posts such as Regimental Headquarters.

The *Exterminator's* Magna 390XL engine offers heavy power curves with an improved power-to-weight ratio, giving the sixty-five-ton *Exterminator* the kind of maneuverability usually reserved for twenty-ton scout 'Mechs. Chevron II jump jets allow the 'Mech to jump up to 180 meters when necessary. With a maximum speed of 97 kph, this 'Mech can be very difficult to intercept.

Because the *Exterminator* must infiltrate enemy positions and rapidly eliminate key commanders and their 'Mechs, its weapons are designed with close combat in mind. The 'Mech's major close-range weapons are its four Averell Highpoint medium lasers, two mounted on each forearm. One favorite tactic of *Exterminator* pilots is to sneak up to a target 'Mech, deliver double punches with their 'Mech's armored fists, then fire its double lasers into the gouges just created. A Deadeye LRM-10 rack is mounted on the upper central torso; a head-mounted Dinotech Mark III small laser and the Buzzsaw anti-missile system mounted on the right shoulder round out the 'Mech's weapons array.

The *Exterminator's* Fibrolyte Armorscale was improved with anti-laser ablatives added to the first four layers, giving the 'Mech an intense silver sheen when not screened. This armor must be kept clean to ensure that the reflective laser defense works efficiently.

Critical to its mission are the 'Mech's electronic countermeasure and null signature systems. The 'Mech shunts the heat created by normal operations through a series of heat baffles in its feet, making it difficult to pick up the *Exterminator's* "footprints." The phased-array sensor system, the sheathed directional communication beacon and the Chameleon shield add to the 'Mech's ability to remain hidden while covering great distances.

EXT-4D EXTERMINATOR

Mass: 65 tons
Chassis: SL Special
Power Plant: Magna 390 XL
Cruising Speed: 65 kph
Maximum Speed: 97 kph
Jump Jets: Chevron II
Jump Capacity: 180 meters

Armor: Fibrolyte Armorscale

Armament:
 1 Deadeye LRM-10 Missile Rack
 4 Averell Highpoint Medium Lasers
 1 Dinotech Mark III Small Laser
 1 Buzzsaw Anti-Missile System

Manufacturer: General Systems

Communications System: AR-12 Sheathed Directional Beacon

Targeting and Tracking System: DLK Type Phased Array Sensors

Type: **Exterminator**

Technology Base: Inner Sphere

Tonnage: 65

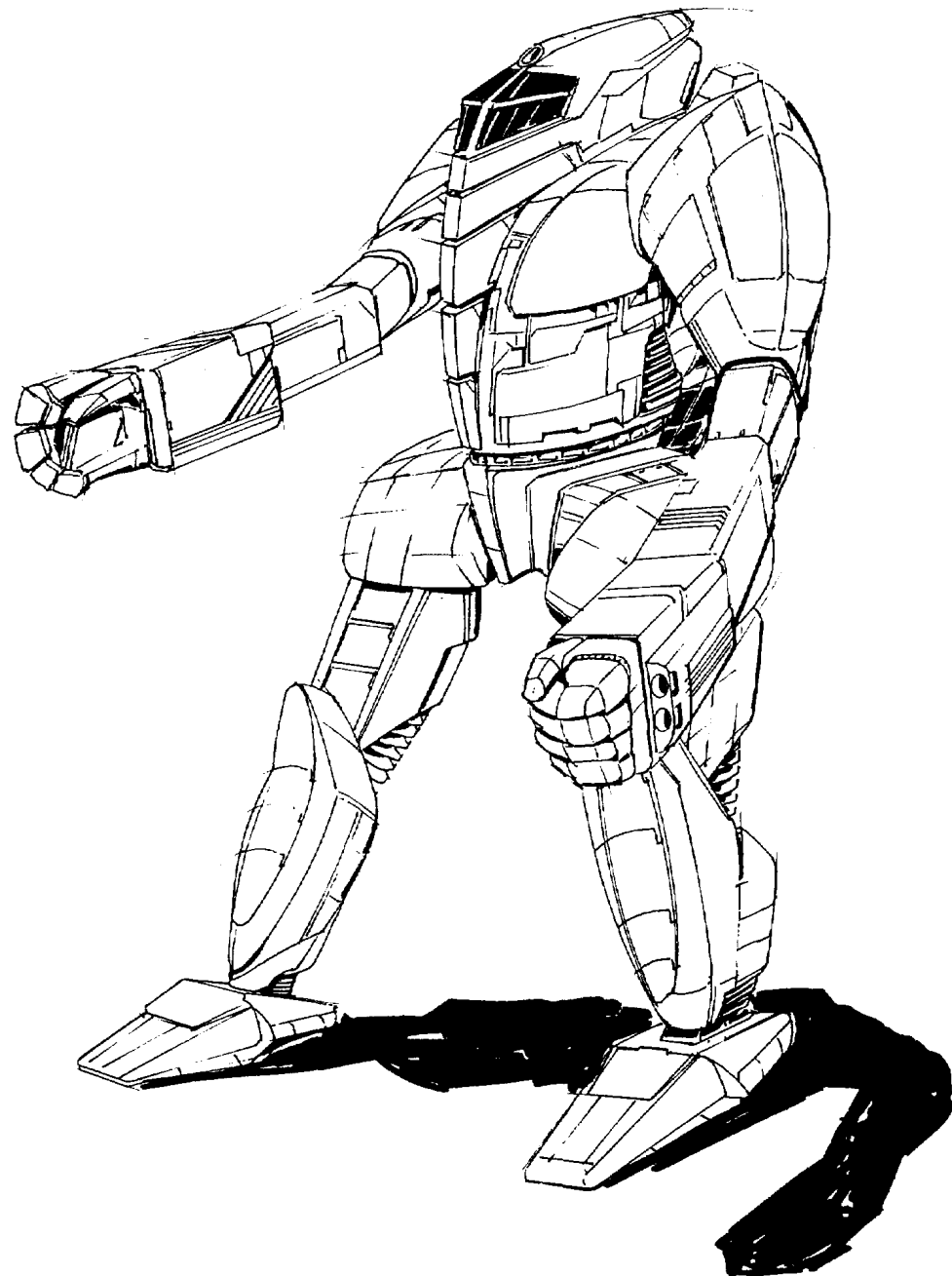

Equipment		Mass
Internal Structure:		6.5
Engine:	390 XL	23
Walking MP:	6	
Running MP:	9	
Jumping MP:	6	
Heat Sinks:	10 [20]	0
Gyro:		4
Cockpit:		3
Armor Factor:	168	10.5

	Internal Structure	Armor Value
--	--------------------	-------------

Head	3	9
Center Torso	21	21
Center Torso (rear)		8
R/L Torso	15	20
R/L Torso (rear)		8
R/L Arm	10	18
R/L Leg	15	19

Weapons and Ammo	Location	Critical	Tonnage
LRM 10	LT	2	5
Ammo (LRM) 12	CT	1	1
Medium Laser	RA	1	1
Medium Laser	RA	1	1
Medium Laser	LA	1	1
Medium Laser	LA	1	1
Small Laser	H	1	.5
Anti-Missile System	RT	1	.5
Ammo (Anti-Missile) 12	RT	1	1
Jump Jets	RT	3	3
Jump Jets	LT	3	3



OVERVIEW

The JM6-DD *JagerMech* is an updated version of the successful JM6-S *JagerMech*. Like the JM6-S, the new *JagerMech* features four arm-mounted autocannons, which provide the 'Mech with generous firepower and make it an excellent choice for fire-support missions. However, the designers at Kallon Industries have provided the JM6-DD with even greater hitting power than its predecessor by substituting two General Motors Nova-5 autocannons for the JM6-S's Mydron Model C autocannons and replacing the earlier model's Magna Mark II medium lasers with two Sutel Precision Line medium pulse lasers. In addition to fire-support duties, the *JagerMech* also makes an effective anti-aircraft weapon, thanks to its powerful autocannons and sophisticated Garret D2j targeting system.

The JM6-DD also features Cellular Ammunition-Storage Equipment and 6.5 tons of Kallon Unity Weave ferro-fibrous armor, which provide 21 percent more protection than the JM6-S's Kallon Royalstar armor.

Mass: 65 tons
Chassis: Kallon Type XII
Power Plant: Magna 260 XL
Cruising Speed: 43.2 kph
Maximum Speed: 64.8 kph
Jump Jets: None
Jump Capacity: None

Armor: Kallon Unity Weave Ferro-Fibrous with CASE
Armament:

- 2 General Motors Nova-5 Autocannons
- 2 Mydron Model D Light Autocannons
- 2 Sutel Precision Line Medium Pulse Lasers

Manufacturer: Kallon Industries, Independence Weaponry

Primary Factory: Talon (Kallon), Quentin (Independence)

Communications System: Garret T11-A

Targeting and Tracking System: Garret D2j

Type: **JagerMech**

Technology Base: Inner Sphere

Tonnage: 65

Equipment		Mass
Internal Structure:		6.5
Engine:	260 XL	7
Walking MP:	4	
Running MP:	6	
Jumping MP:	0	
Heat Sinks:	10	0
Gyro:		3
Cockpit:		3
Armor Factor:	116	6.5

	Internal Structure	Armor Value
Head	3	9
Center Torso	21	18
Center Torso (rear)		5
R/L Torso	15	17
R/L Torso (rear)		5
R/L Arm	10	8
R/L Leg	15	12

Weapons and Ammo	Location	Critical	Tonnage
Ultra AC/5	RA	5	9
Ammo (Ultra) 20	RT	1	1
AC/2	RA	1	6
Ammo (AC) 45	RT	1	1
CASE	RT	1	.5
Ultra AC/5	LA	5	9
Ammo (Ultra) 20	LT	1	1
AC/2	LA	1	6
Ammo (AC) 45	LT	1	1
CASE	LT	1	.5
Medium Pulse Laser	RT	1	2
Medium Pulse Laser	LT	1	2

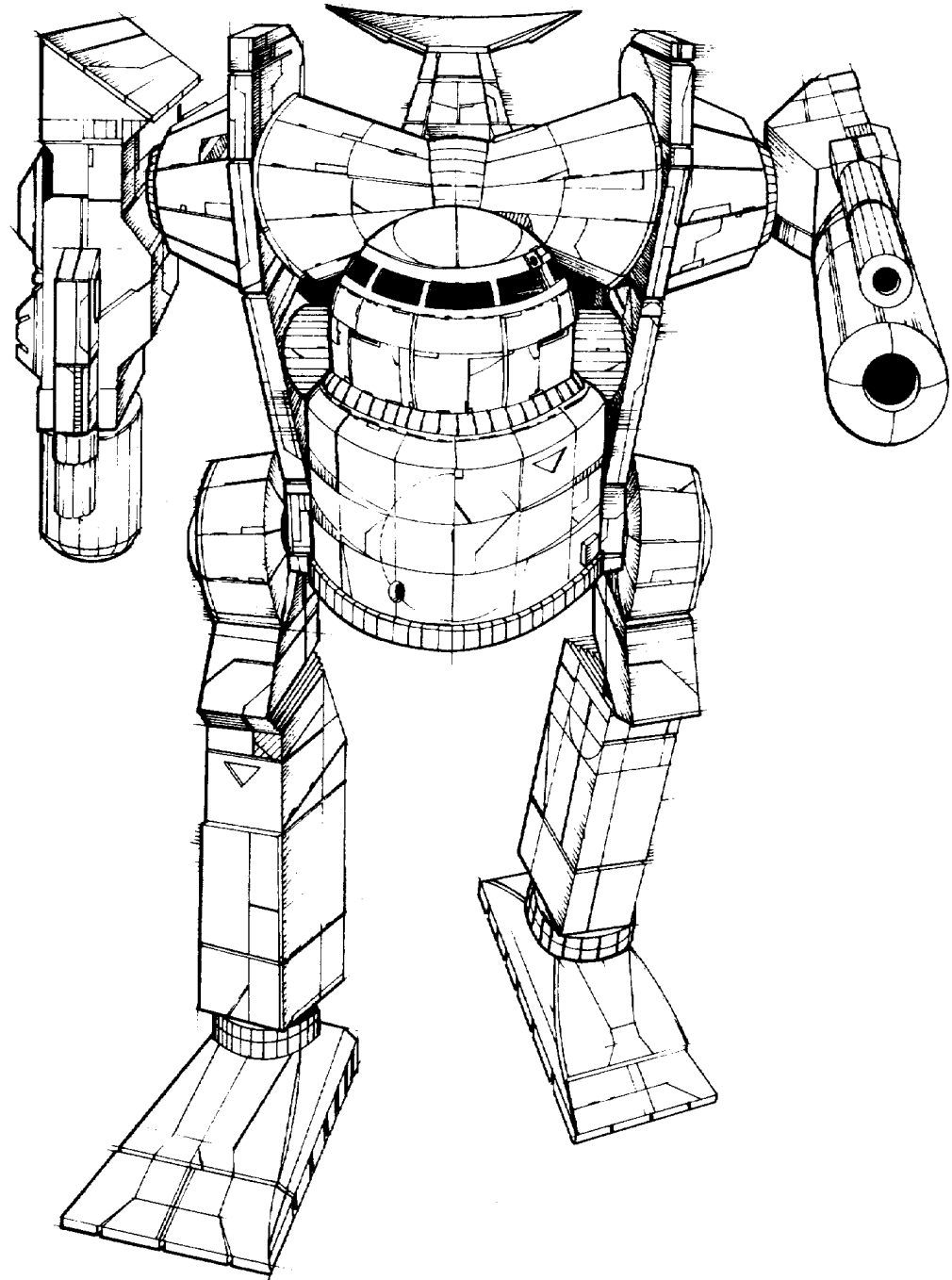



OVERVIEW

Although the Federated Commonwealth's new CES-3R *Caesar* was modeled after a captured Capellan *Cataphract*, most military analysts recognize the *Caesar* as a distinct BattleMech design in its own right. Built around the Dorwinion Standard chassis and the General Motors 280 extra-light power plant, the *Caesar* incorporates the latest advances in BattleMech technology in its armor and weaponry as well.

Ten and a half tons of Kallon Royalstar armor provide the *Caesar* with ample protection, while a torso-mounted Poland Main Model A Gauss rifle—a massive weapon not seen in the Successor States since the fall of the Star League—gives the 'Mech deadly striking power. And the *Caesar's* CASE-protected ammo bins can store up to two tons of reloads for the Gauss rifle, greatly reducing the likelihood that a *Caesar* pilot will run out of Gauss ammunition at an inopportune moment.

Additionally, the supporting weaponry in the *Caesar's* arsenal comprises some of the most advanced offensive systems available in the Inner Sphere today. The Johnston High Speed long-range particle projection cannon is so new that the Federated Commonwealth has yet to battle-test the weapon, which has performed beyond its designers' expectations in factory trials. And the *Caesar's* four state-of-the-art torso- and arm-mounted Sutel Precision Line medium pulse lasers provide additional front and rear firepower.

Mass: 70 tons
Chassis: Dorwinion Standard
Power Plant: VOX 280 XL
Cruising Speed: 43.2 kph
Maximum Speed: 64.8 kph
Jump Jets: None
Jump Capacity: None
Armor: Kallon Royalstar with CASE

Armament:
 1 Poland Main Model A Gauss Rifle
 1 Johnston High Speed Extended Range PPC
 4 Sutel Precision Line Medium Pulse Lasers
Manufacturer: Johnston Industries
Primary Factory: New Syrtis
Communications System: Johnston Wide Band
Targeting and Tracking System: Rander Pinpoint-HY

Type: **Caesar**
 Technology Base: Inner Sphere
 Tonnage: 70

Equipment		Mass
Internal Structure:		7
Engine:	280 XL	8
Walking MP:	4	
Running MP:	6	
Jumping MP:	0	
Heat Sinks:	16 [32]	6
Gyro:		3
Cockpit:		3
Armor Factor:	168	10.5
	<i>Internal Structure</i>	<i>Armor Value</i>
Head	3	9
Center Torso	22	26
Center Torso (rear)		7
R/L Torso	15	15
R/L Torso (rear)		6
R/L Arm	11	21
R/L Leg	15	21

Weapons and Ammo	Location	Critical	Tonnage
Gauss Rifle	RT	7	15
Ammo (Gauss) 16	LT	2	2
CASE	RT	1	.5
ER PPC	RA	3	7
Medium Pulse Laser	LA	1	2
Medium Pulse Laser	RA	1	2
Medium Pulse Laser	LT (R)	1	2
Medium Pulse Laser	RT (R)	1	2

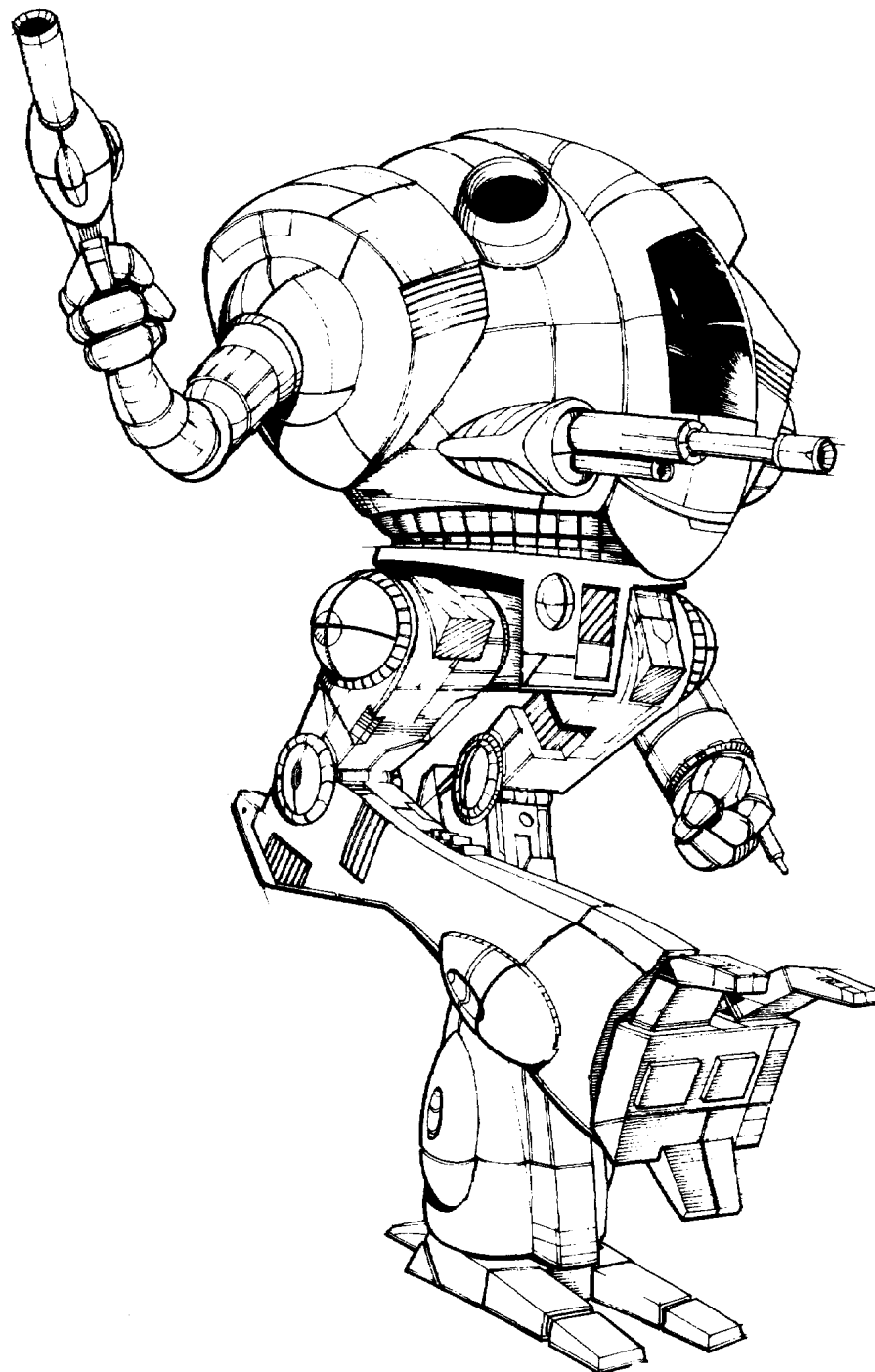



OVERVIEW

The Federated Commonwealth began work on the CTF-3D *Cataphract* shortly after capturing the main Earthwerks BattleMech factory on Tikonov—one of the Commonwealth's greatest accomplishments of the Fourth Succession War. The Tikonov Earthwerks plant had been far and away the largest 'Mech producer in the Capellan Confederation and served as the main supplier of House Liao's *Cataphract*, one of the most successful Capellan heavy 'Mechs.

The new CTF-3D design employs the General Motors 280 extra-light engine, which provides the 'Mech with a top speed of 64.8 kph, and also incorporates four HildCo Model 12 jump jets, which give the 70-ton 'Mech a jump capacity of 120 meters. In place of the heat-producing PPC of the original Liao design, the CTF-3D substitutes a powerful arm-mounted General Motors Nova-5 autocannon and replaces the original *Cataphract's* autocannon with the advanced Mydron Excel LB 10-X.

Meanwhile, House Liao has been busy retooling Earthwerks' smaller Grand Base facility for production of its own updated *Cataphract*—the CTF-3L, which also contains some impressive innovations. The new Capellan *Cataphract* features double heat sinks and replaces the original design's PPC with the new Ceres Arms Warrior extended-range particle projection cannon. Additionally, the CTF-3L boasts four Ceres Arms Model W medium lasers and Myomer-Accelerator Signal Circuitry for additional speed in emergencies.

Mass: 70 tons
Chassis: Earthwerks CTF
Power Plant: VOX 280 XL
Cruising Speed: 43.2 kph
Maximum Speed: 64.8 kph
Jump Jets: HildCo Model 12
Jump Capacity: 120 meters
Armor: Kallon Royalstar with CASE
Armament:
 1 Mydron Excel LB 10-X Autocannon
 1 General Motors Nova-5 Autocannon
 4 Intek Medium Lasers
Manufacturer: Earthwerks Incorporated
Primary Factory: Tikonov
Communications System: CommuTech Multi-Channel 10
Targeting and Tracking System: BlazeFire Sightlock

Type: Cataphract
Technology Base: Inner Sphere
Tonnage: 70

Equipment		Mass
Internal Structure:		7
Engine:	280 XL	8
Walking MP:	4	
Running MP:	6	
Jumping MP:	4	
Heat Sinks:	16	6
Gyro:		3
Cockpit:		3
Armor Factor:	176	11
	<i>Internal Structure</i>	<i>Armor Value</i>
Head	3	9
Center Torso	22	26
Center Torso (rear)		9
R/L Torso	15	16
R/L Torso (rear)		9
R/L Arm	11	22
R/L Leg	15	19

Weapons and Ammo	Location	Critical	Tonnage
LB 10-X AC	RT	6	11
Ammo (LB-X) 20	LT	2	2
CASE	LT	1	.5
Ultra AC/5	RA	5	9
Ammo (Ultra) 20	RT	1	1
Medium Laser	LA	1	1
Medium Laser	RA	1	1
Medium Laser	LT (R)	1	1
Medium Laser	RT (R)	1	1
Jump Jets	RL	2	2
Jump Jets	LL	2	2

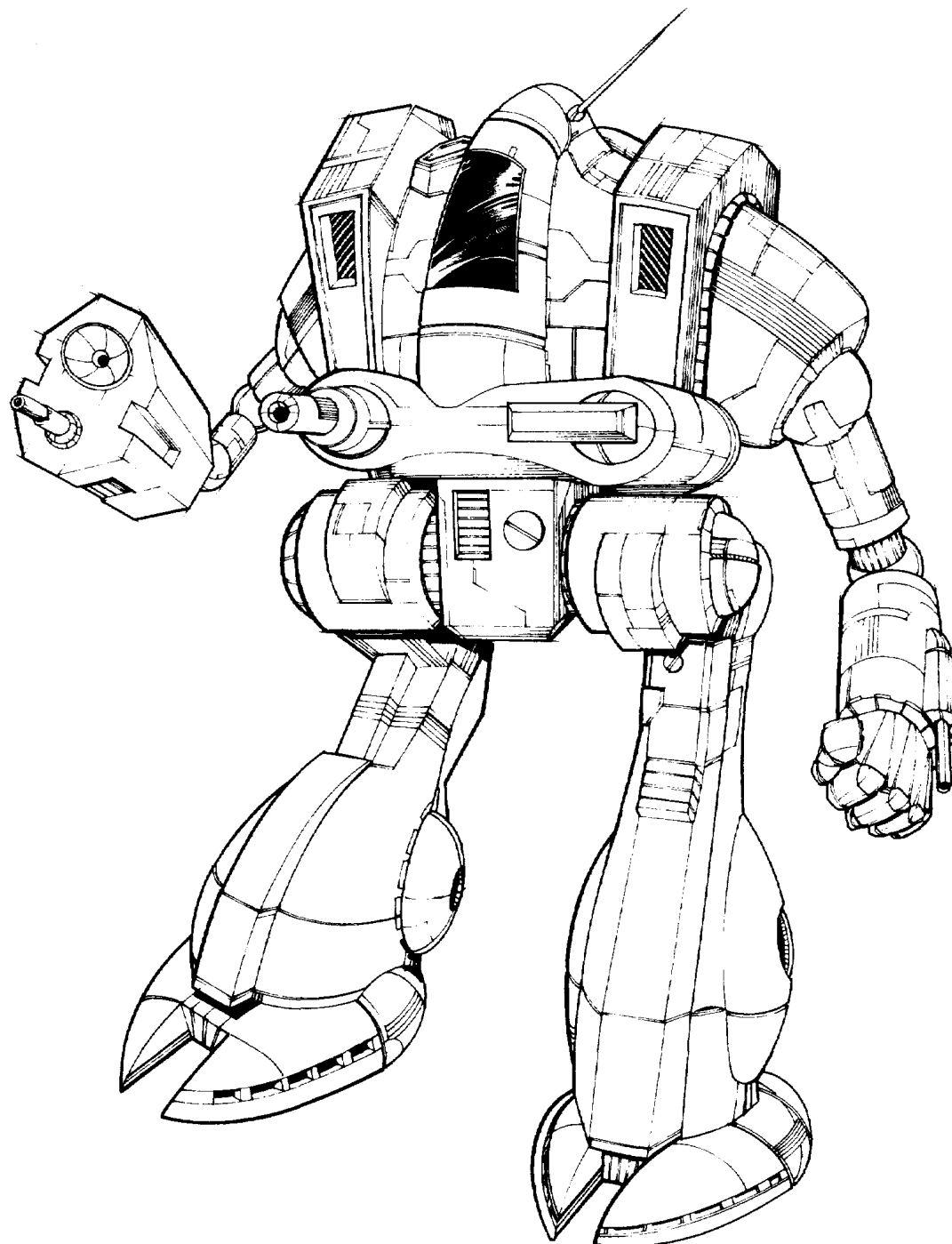



OVERVIEW

The GHR-5J *Grasshopper* is a modified version of the Star League-era GHR-5H *Grasshopper*. Although the *Grasshopper* is no longer produced in large numbers, the popular design remains in widespread use with BattleMech units throughout the Inner Sphere, and increasing numbers of *Grasshopper* owners are turning to the GHR-5J field-modification kit to upgrade their machines.

Mercenary 'Mech units in particular have long valued the *Grasshopper* for its laser-heavy weapons array, which enables *Grasshoppers* to operate for long periods of time without needing to reload at supply depots. Additionally, the *Grasshopper* is prized for its superior mobility (the *Grasshopper* was one of the first heavy 'Mech designs to incorporate jump jets), which often enables a *Grasshopper* pilot to outflank opposing heavy 'Mechs and attack from unexpected directions.

The GHR-5J builds on the *Grasshopper's* strengths by substituting a Diverse Optics Sunbeam extended-range large laser in place of the original design's Diplan heavy laser. The modification kit also includes a head-mounted Hovertec Streak SRM-2 pod, which provides the *Grasshopper* with a close-combat weapon, as well as a torso-mounted SureFire 444 anti-missile system to augment the *Grasshopper's* relatively light armor.

GHR-5J GRASSHOPPER

Mass: 70 tons
Chassis: Mingh z33/7
Power Plant: VOX 280
Cruising Speed: 43.2 kph
Maximum Speed: 64.8 kph
Jump Jets: Leviathan Lifters
Jump Capacity: 120 meters
Armor: Durallex Heavy
Armament:
 1 Diverse Optics Sunbeam Extended Range Large Laser
 2 Diplan M3 Medium Lasers
 1 Hovertec Streak SRM-2 Pod
 1 SureFire 444 Anti-Missile System
Manufacturer: Lantren Corporation
Primary Factory: Bryant
Communications System: Allet-C308
Targeting and Tracking System: Allet-T11

Type: **Grasshopper**
 Technology Base: Inner Sphere
 Tonnage: 70

Equipment		Mass
Internal Structure:		7
Engine:	280	16
Walking MP:	4	
Running MP:	6	
Jumping MP:	4	
Heat Sinks:	22	12
Gyro:		3
Cockpit:		3
Armor Factor:	208	13
	<i>Internal Structure</i>	<i>Armor Value</i>
Head	3	9
Center Torso	22	30
Center Torso (rear)		13
R/L Torso	15	20
R/L Torso (rear)		10
R/L Arm	11	22
R/L Leg	15	26

Weapons and Ammo	Location	Critical	Tonnage
ER Large Laser	CT	2	5
Medium Laser	RA	1	1
Medium Laser	LA	1	1
Streak SRM 2	H	1	1.5
Ammo (Streak) 100	RT	2	2
Anti-Missile System	RT	1	.5
Ammo (Anti-Missile) 12	LT	1	1
Jump Jets	LL	2	2
Jump Jets	RL	2	2

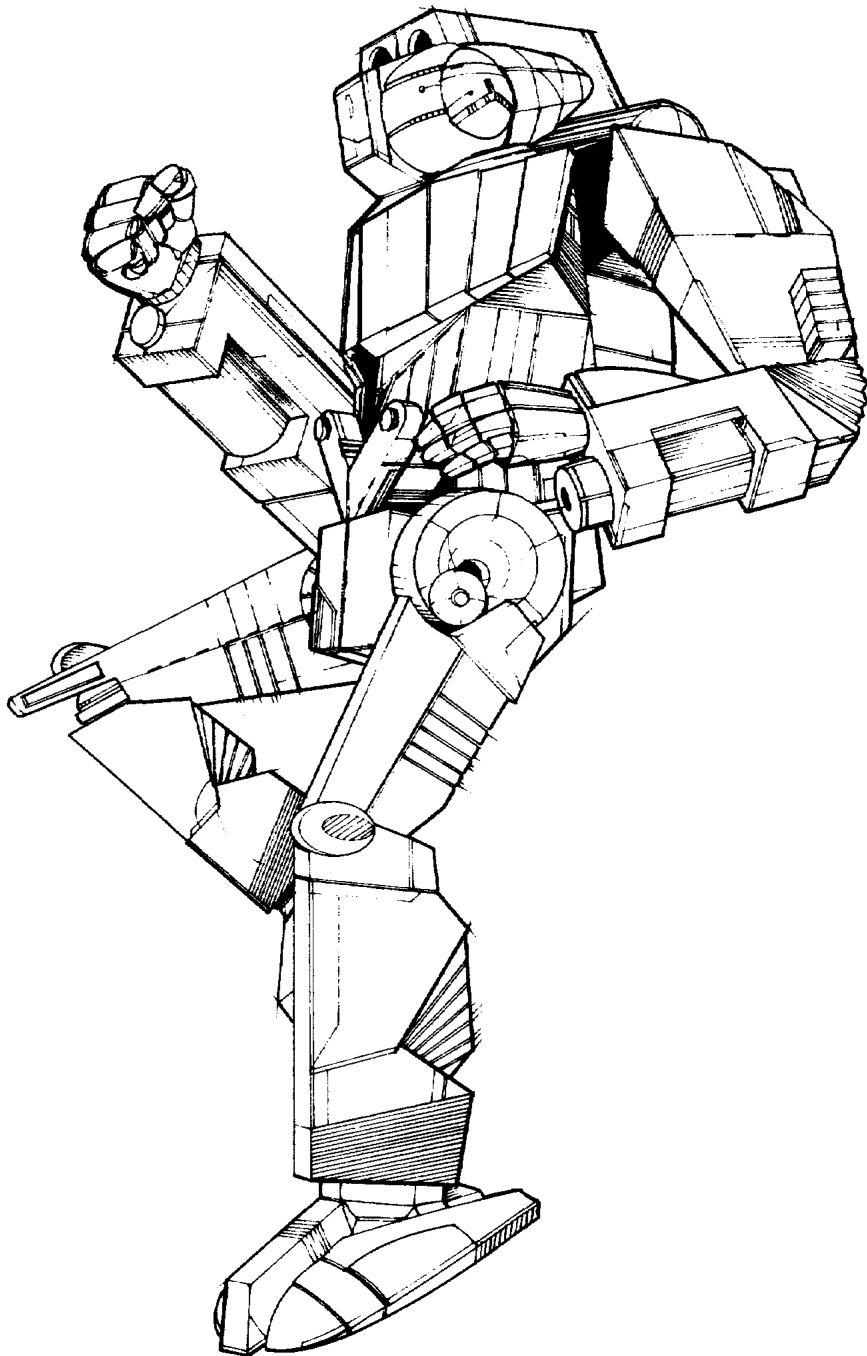



OVERVIEW

The recovery of Star League-era technology and know-how has allowed Inner Sphere BattleMech manufacturers to make many improvements on common 'Mech designs. In the case of the *Guillotine*, recovered technology has resurrected a design thought lost to the vagaries of warfare. Even though the Succession Wars left the production line for the *Guillotine* at Irian BattleMechs Unlimited's primary factory on Irian unscathed, the *Guillotine* went out of production for lack of sophisticated Star League equipment and weapons, primarily the endo steel for the 'Mech's internal structure. Engineers replaced the weapons with similar ones of almost equal quality, but the loss of the ability to produce endo steel was a hurdle they could not jump. Other construction materials were simply too heavy, requiring the removal of crucial weapons systems.

Since the recovery of the necessary technical knowledge, Irian BattleMechs has revived the design by using Crucis-II Deluxe endo steel. The designers have even improved on the original 'Mech by substituting a Diverse Optics Sunbeam extended-range large laser for the older Sunglow model.

Mass: 70 tons
Chassis: Crucis-II Deluxe Endo Steel
Power Plant: VOX 280
Cruising Speed: 43 kph
Maximum Speed: 65 kph
Jump Jets: Anderson 398
 Jump Capacity: 120 meters
Armor: Durallex Heavy Special with CASE
Armament:
 1 Diverse Optics Sunbeam Extended Range Large Laser
 1 Irian Weapons Works 60 mm SRM-6 Missile Rack
 4 Irian Weapons Works Super 6 Medium Lasers
Manufacturer: Irian BattleMechs Unlimited
 Primary Factory: Irian
Communications System: Irian Technologies HMR-35s
Targeting and Tracking System: Omicron TrackerKeeper

Type: Guillotine
Technology Base: Inner Sphere
Tonnage: 70

Equipment		Mass
Internal Structure:	Endo	3.5
Engine:	280	16
Walking MP:	4	
Running MP:	6	
Jumping MP:	4	
Heat Sinks:	25	15
Gyro:		3
Cockpit:		3
Armor Factor:	192	12
	<i>Internal Structure</i>	<i>Armor Value</i>
Head	3	9
Center Torso	22	27
Center Torso (rear)		12
R/L Torso	15	22
R/L Torso (rear)		8
R/L Arm	11	20
R/L Leg	15	22

Weapons and Ammo	Location	Critical	Tonnage
ER Large Laser	LA	2	5
SRM 6	CT	2	3
Ammo (SRM) 15	RT	1	1
CASE	RT	1	.5
Medium Laser	RT	1	1
Medium Laser	LT	1	1
Medium Laser	RA	1	1
Medium Laser	RA	1	1
Jump Jet	RT	1	1
Jump Jet	LT	1	1
Jump Jet	RL	1	1
Jump Jet	LL	1	1

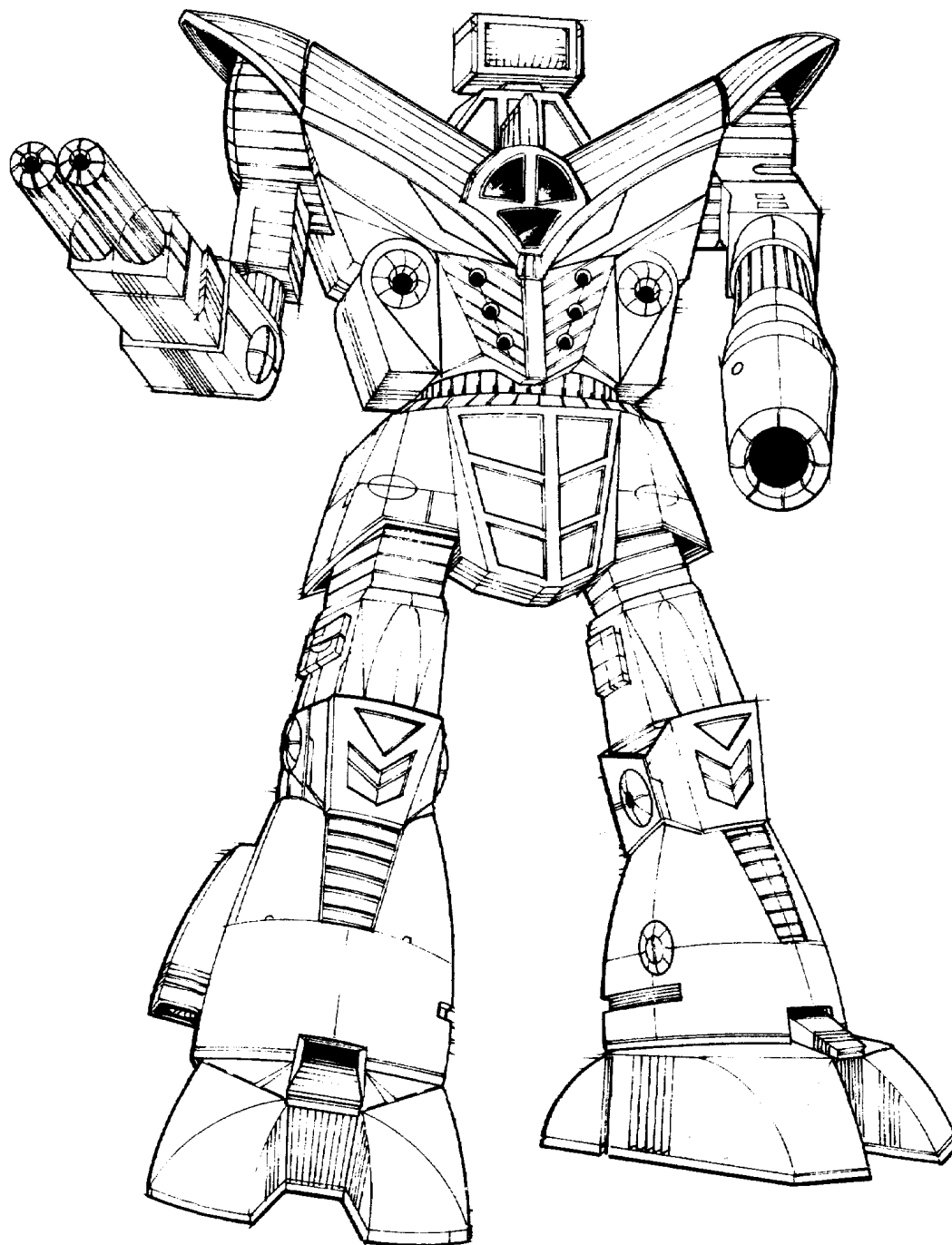

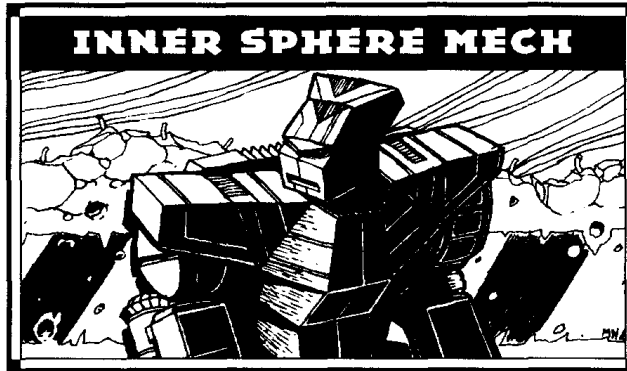

OVERVIEW

Introduced in 2578 by the Star League Defense Forces, the *Black Knight's* heavy armor and offensive power make it the ideal command 'Mech for front-line units. At the same time, its impressive arsenal allows the 'Mech to operate effectively on its own.

The *Black Knight's* endo steel II frame provides all the support of a standard skeleton twice its weight. The resulting lighter frame allows the 'Mech to mount a heavier weapons mix and an ample fifteen tons of ferro-fibrous armor, for a total mass of seventy-five tons. A maximum speed of 65 kph, ample firepower and a Beagle active probe designed to pick up a wide range of information and relay it instantly to the pilot add to this 'Mech's excellent performance in the field.

The 'Mech's main weapon is the Magna Hellstar II particle projection cannon, which provides quick and deadly fire. Twin McCorkel large lasers and Maxell medium lasers provide additional firepower. A head-mounted Magna small laser rounds out the weapons system. The Beagle active probe, tied directly to the weapons system, provides an additional advantage. In addition to its ability to pierce standard ECM devices at short range and instantly catalog all military machines, the weapons tie-in allows the Beagle's scanner to ride a low-power laser pulse through any interfering objects. The laser's limited range, however, makes this strategy effective only for analyzing the details of nearby objects.

Heat buildup is the most noticeable problem connected with the *Black Knight*. Even with twenty heat sinks, the 'Mech can still overheat quickly if the pilot is not careful when selecting which weapons to fire.

BL-6-KNT BLACK KNIGHT

Mass: 75 tons
Chassis: Technicon 1L
Power Plant: Vlar 300
Cruising Speed: 43 kph
Maximum Speed: 65 kph
Jump Jets: None
Jump Capacity: None
Armor: Numall DuraBond

Armament:
 1 Magna HellStar II PPC
 2 McCorkel Large Lasers
 4 Maxell DT Medium Lasers
 1 Magna Small Laser

Manufacturer: Kong Interstellar Corporation
Communications System: TransComm Alpha
Targeting and Tracking System: Beagle Active Probe

Type: **Black Knight**
 Technology Base: Inner Sphere
 Tonnage: 75

Equipment		Mass
Internal Structure:	Endo	4
Engine:	300	19
Walking MP:	4	
Running MP:	6	
Jumping MP:	0	
Heat Sinks:	20	10
Gyro:		3
Cockpit:		3
Armor Factor:	208	13
	<i>Internal Structure</i>	<i>Armor Value</i>
Head	3	9
Center Torso	23	29
Center Torso (rear)		10
R/L Torso	16	24
R/L Torso (rear)		8
R/L Arm	12	24
R/L Leg	16	24

Weapons and Ammo	Location	Critical	Tonnage
PPC	RA	3	7
Large Laser	RT	2	5
Large Laser	LT	2	5
Medium Laser	RT	1	1
Medium Laser	LT	1	1
Medium Laser	RA	1	1
Medium Laser	LA	1	1
Small Laser	H	1	.5
Beagle Active Probe	CT	2	1.5

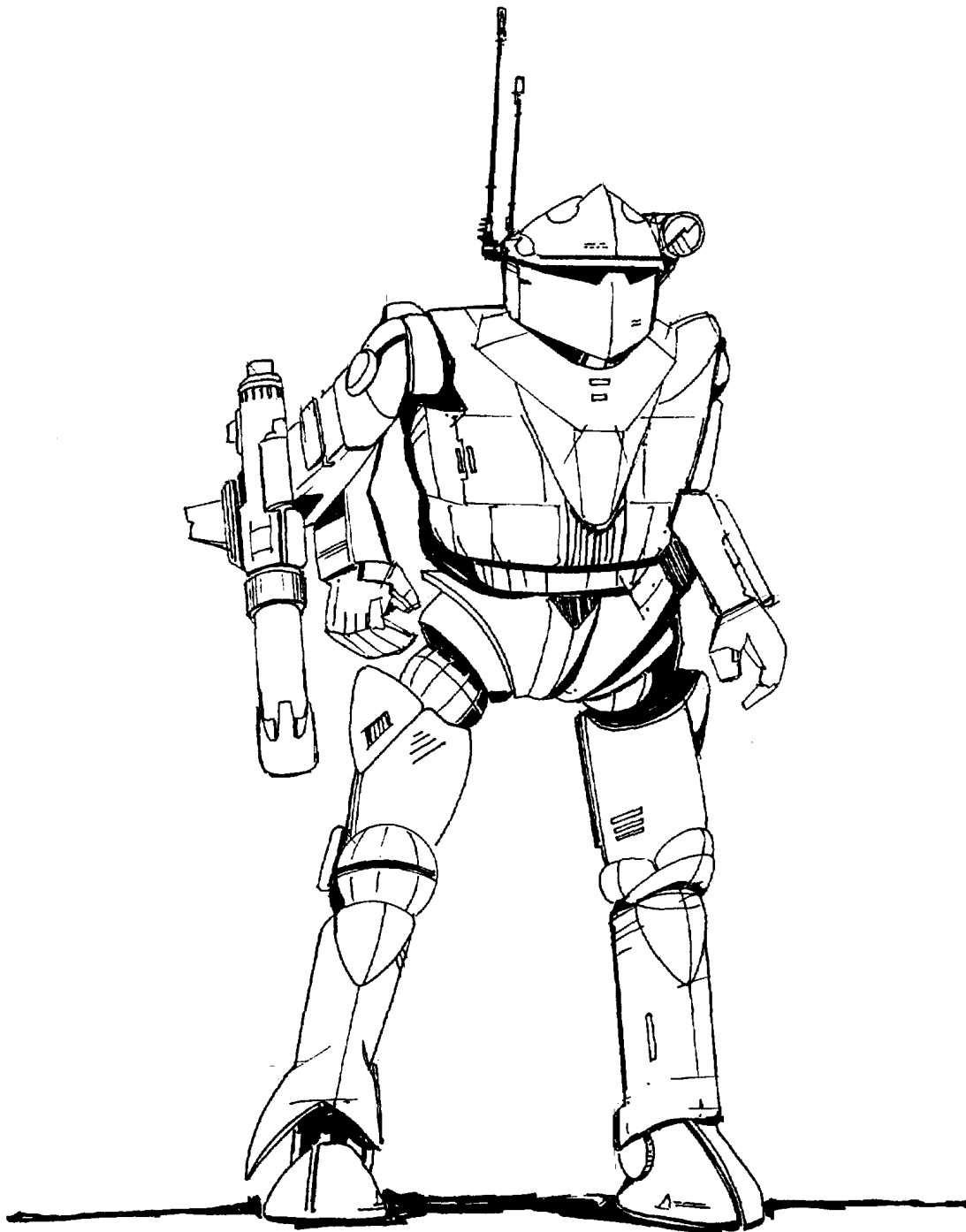



OVERVIEW

One of the most underrated 'Mech designs of the Star League era, the *Flashman* was designed to be independent on the battlefield, as it was not tied to the ammunition supply lines. The 'Mech is essentially a walking platform for a high-energy laser battery, with a preponderance of energy weapons along with its standard anti-missile cannon and an optional head-mounted anti-personnel flamer.

First produced in 2701, the *Flashman* is a heavy 'Mech designed for high-level combat. Its GM 375 XL engine generates power with unparalleled efficiency. Though it is not jump-capable, it is quite nimble for a seventy-five-ton 'Mech, with a maximum speed of 86 kph. The *Flashman's* Kemplar 5000 armor lets this 'Mech take extensive punishment before succumbing to system failure.

The *Flashman* is armed with three Selitex Radionic large lasers, one mounted in each forearm and one mounted in the center torso. Five Ichiba 3000 medium lasers complement their larger counterparts, and are mounted in the right and left torso and coaxially with the large lasers in the right and left arms. A rear-facing mount is also included, along with a Buzzsaw anti-missile system and a Zippo Mark SL-13X anti-personnel flame gun in a head mount beneath the pilot's cockpit. Fifteen improved SL-13 heat sinks efficiently purge the weapons of waste heat. The 'Mech's Faust/Shinji auto-tracking and targeting system makes the *Flashman* one of the most accurate BattleMechs in existence.

The *Flashman* is most useful when assigned to line regiments to provide energy weapon support during attacks on prepared positions or in general field combat, and is also ideally suited for a rear-guard role when the rest of the lance runs low on ammunition. In addition, the *Flashman* can be used in a kamikaze charge when a defense force seems to waver.

Mass: 75 tons
Chassis: FLS/HV-1
Power Plant: GM 375 XL
Cruising Speed: 54 kph
Maximum Speed: 86 kph
Jump Jets: None
Jump Capacity: None
Armor: Kemplar 5000
Armament:
 3 Seltex Radionic Large Lasers
 5 Ichiba 3000 Medium Lasers
 1 Buzzsaw Anti-Missile System
 1 Zippo Mark X Anti-Personnel Flame Gun
Manufacturer: Renault-Prime Industries
Communications System: Duoteck 195
Targeting and Tracking System: Faust/Shinji AT/TS

Type: Flashman
Technology Base: Inner Sphere
Tonnage: 75

Equipment		Mass
Internal Structure:		7.5
Engine:	375 XL	19.5
Walking MP:	5	
Running MP:	8	
Jumping MP:	0	
Heat Sinks:	15 [30]	5
Gyro:		4
Cockpit:		3
Armor Factor:	216	13.5
	<i>Internal Structure</i>	<i>Armor Value</i>
Head	3	9
Center Torso	23	25
Center Torso (rear)		16
R/L Torso	16	22
R/L Torso (rear)		10
R/L Arm	12	24
R/L Leg	16	27

Weapons and Ammo	Location	Critical	Tonnage
Large Laser	RA	2	5
Large Laser	LA	2	5
Large Laser	CT	2	5
Medium Laser	RT	1	1
Medium Laser	LT	1	1
Medium Laser	LA	1	1
Medium Laser	RA	1	1
Medium Laser	LT (R)	1	1
Anti-Missile System	RT	1	.5
Ammo (Anti-Missile) 12	RT	1	1
Flamer	H	1	1

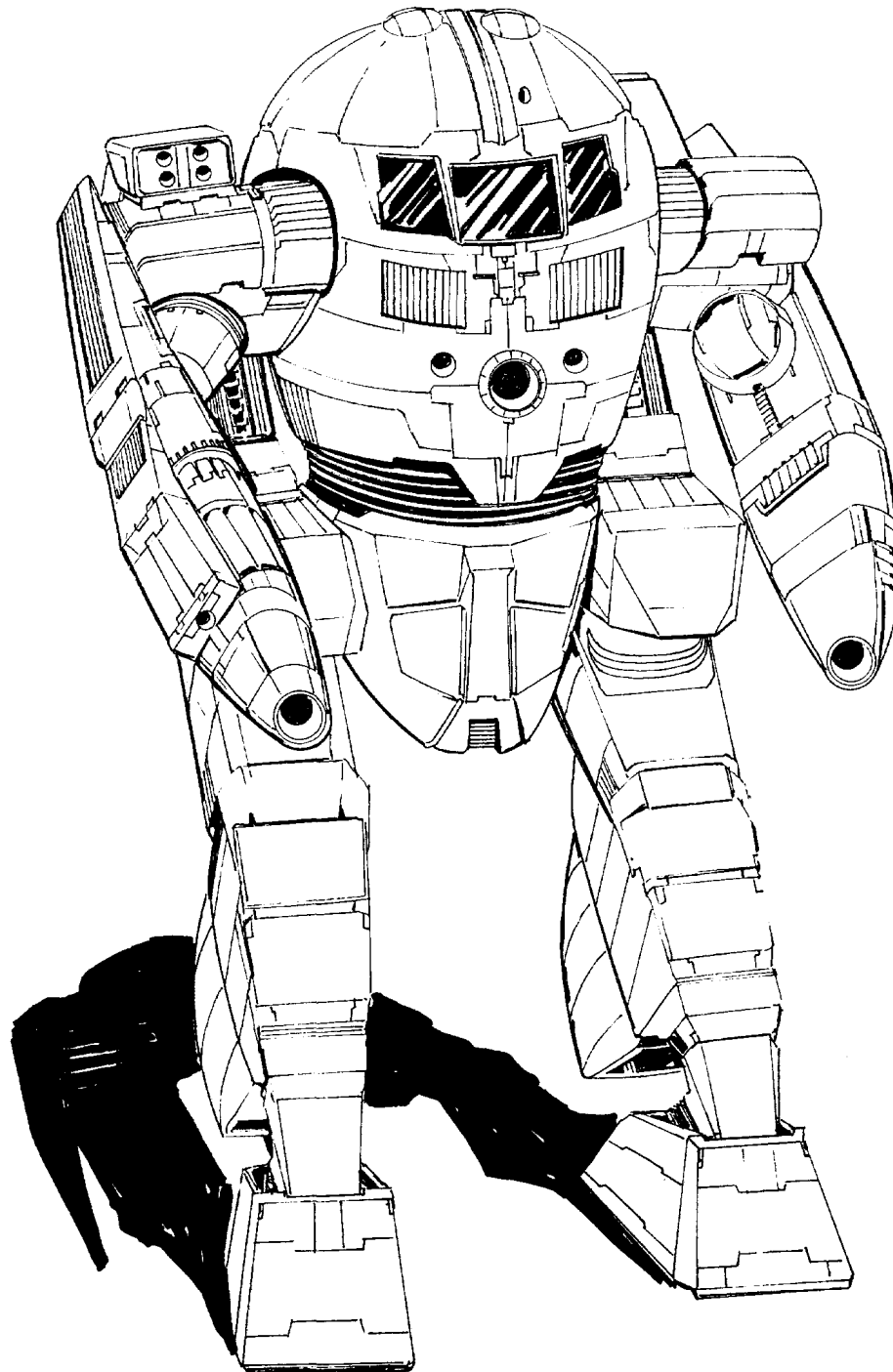



OVERVIEW

The first true heavy 'Mech ever produced, the well-designed *Orion* has served on the battlefields of the Inner Sphere for nearly 500 years and remains a formidable machine even today. The ON1-M version incorporates the latest technology and promises to ensure that the *Orion* remains a common sight on 'Mech battlefields well into the foreseeable future.

The most obvious innovation of the ON1-M is the arm-mounted Kali Yama Weapons Industries Type V LRM-20 missile rack and the Octagon Missile-Magnet narc beacon. These systems replace the troublesome 15-shot Death Bloom missile system found on earlier *Orions* and provide the 'Mech with markedly improved long-range firepower. The ON1-M also features the sophisticated Kali Yama LB 10-X autocannon, which possesses greater range, accuracy and reliability than the temperamental autocannon of previous *Orions*. Additionally, the new ON1-M features cellular ammunition-storage equipment, which protects the BattleMech's weapon reloads from enemy hits, double heat sinks for more rapid heat dissipation, and a Hermes 300 XL extra-light power plant.

Mass: 75 tons
Chassis: Kali Yama Chassis
Power Plant: Vlar 300 XL
Cruising Speed: 43.2 kph
Maximum Speed: 64.8 kph
Jump Jets: None
Jump Capacity: None
Armor: Valliant Lamellor with CASE
Armament:

- 1 Kali Yama Weapons Industries LB 10-X Autocannon
- 1 Kali Yama Weapons Industries Type V LRM-20 Missile Rack
- 1 Irian Weapons Works Class 4 S.R. Missile System
- 1 Octagon Missile-Magnet Narc Beacon
- 2 Irian Weapons Works Medium Lasers

Manufacturer: Kali Yama/Alphard Trading Corp., Kali Yama Weapons Industries

Primary Factory: Kendall, Kalidasa

Communications System: Irian Orator-5K

Targeting and Tracking System: Wasat Aggressor Type 5

Type: Orion
 Technology Base: Inner Sphere
 Tonnage: 75

Equipment		Mass
Internal Structure:		7.5
Engine:	300 XL	9.5
Walking MP:	4	
Running MP:	6	
Jumping MP:	0	
Heat Sinks:	11 [22]	1
Gyro:		3
Cockpit:		3
Armor Factor:	224	14

	Internal Structure	Armor Value
Head	3	9
Center Torso	23	36
Center Torso (rear)		9
R/L Torso	16	22
R/L Torso (rear)		10
R/L Arm	12	21
R/L Leg	16	32

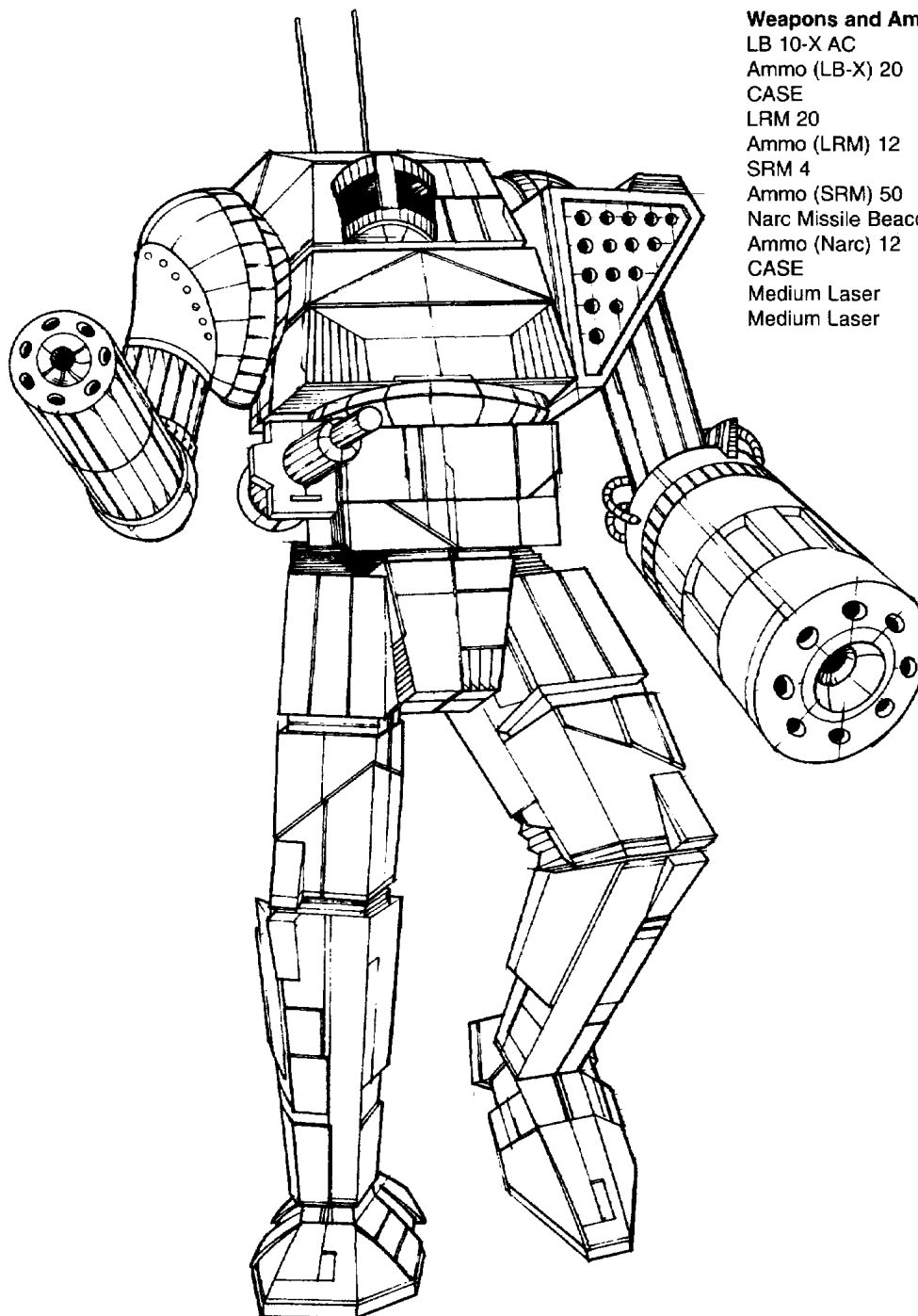

Weapons and Ammo	Location	Critical	Tonnage
LB 10-X AC	RT	6	11
Ammo (LB-X) 20	RT	2	2
CASE	RT	1	.5
LRM 20	LA	5	10
Ammo (LRM) 12	LT	2	2
SRM 4	LT	1	2
Ammo (SRM) 50	LT	2	2
Narc Missile Beacon	CT	2	3
Ammo (Narc) 12	LT	2	2
CASE	LT	1	.5
Medium Laser	RA	1	1
Medium Laser	LA	1	1



OVERVIEW

The *Awesome* has long been a favorite 'Mech among the armies of the Inner Sphere, and so its designers have proved reluctant to modify the design. The AWS-9M version, however, represents a real improvement over the earlier AWS-8Q *Awesome*. The new Hermes 320 XL, for example, provides the new *Awesome* with a top speed of 65.6 kph—a full 28 percent increase over the AWS-8Q's top speed.

Additionally, the AWS-9M features several new weapon systems that greatly enhance the versatility of the *Awesome*. The design features three Fusigon Longtooth extended-range particle projection cannons, which extend the *Awesome's* striking range, and a torso-mounted Magna 400P medium pulse laser for medium-range combat. For short-range fighting, the AWS-9M retains the head-mounted Diverse Optics Type 10 small laser of earlier *Awesomes* and adds arm- and torso-mounted Hovertec Streak SRM-2 pods.

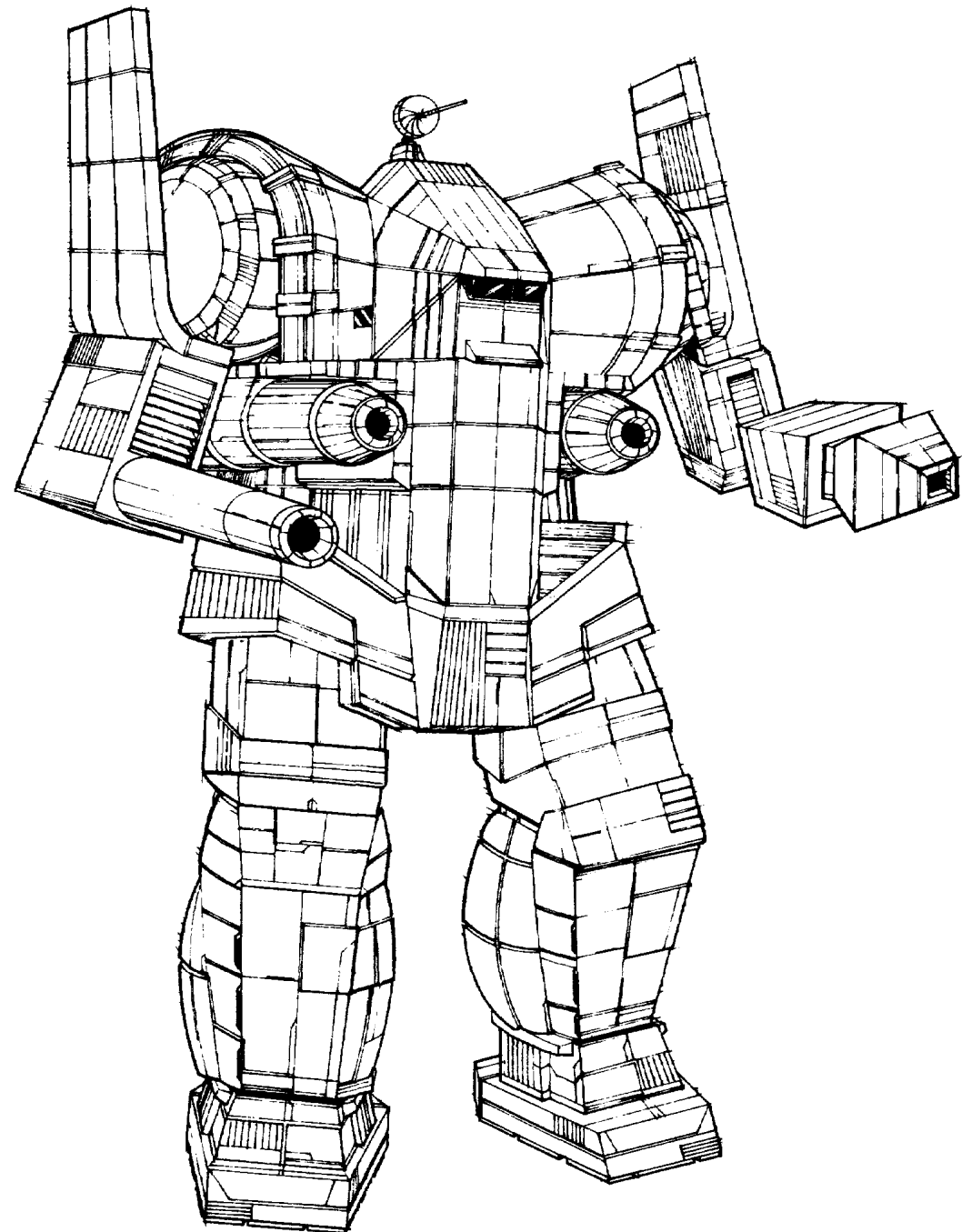

Mass: 80 tons
Chassis: Technicon Type G
Power Plant: Pitban 320 XL
Cruising Speed: 44.1 kph
Maximum Speed: 65.6 kph
Jump Jets: None
Jump Capacity: None
Armor: Durallex Heavy Special

Armament:
 3 Fusigon Longtooth Extended Range PPCs
 1 Diverse Optics Type 10 Small Laser
 1 Magna 400P Medium Pulse Laser
 2 Hovertec Streak SRM-2 Pods
Manufacturer: Technicon Manufacturing, Irian BattleMechs Unlimited
Primary Factory: Savannah (Technicon), Irian (Irian)
Communications System: Garret T19-G
Targeting and Tracking System: Dynatec 2780

Type: Awesome
Technology Base: Inner Sphere
Tonnage: 80

Equipment		Mass
Internal Structure:		8
Engine:	320 XL	11.5
Walking MP:	4	
Running MP:	6	
Jumping MP:	0	
Heat Sinks:	20 [40]	10
Gyro:		4
Cockpit:		3
Armor Factor:	248	15.5
	<i>Internal Structure</i>	<i>Armor Value</i>
Head	3	9
Center Torso	25	30
Center Torso (rear)		20
R/L Torso	17	24
R/L Torso (rear)		10
R/L Arm	13	26
R/L Leg	17	34

Weapons and Ammo	Location	Critical	Tonnage
ER PPC	RA	3	7
ER PPC	RT	3	7
ER PPC	LT	3	7
Small Pulse Laser	H	1	1
Medium Pulse Laser	CT	1	2
Streak SRM 2	CT	1	1.5
Streak SRM 2	LA	1	1.5
Ammo (Streak) 50	LL	1	1



OVERVIEW

The innovations of the CGR-3K *Charger* represent a largely successful attempt by Combine 'Mech designers to improve the versatility and usefulness of the basic *Charger* design.

The New Samarkand Royal ferro-fibrous armor and Cellular Ammunition-Storage Equipment on the CGR-3K, for example, provide superior protection than the armor of previous *Charger* models. More important, the CGR-3K features five Lexington Ltd. Lifter jump jets, which give the CGR-3K a jump capacity of 150 meters and an impressive degree of mobility that earlier *Chargers* lacked. The CGR-3K's greatest innovations, however, are contained in the 'Mech's weapons array, which includes a torso-mounted Shigunga long-range missile 20-rack and four arm- and torso-mounted Victory Heartbeat medium pulse lasers. Additionally, the CGR-3K boasts an Artemis IV fire-control system and a Cat's Eyes 5 targeting and tracking system, which enables a *Charger* pilot to fire his missiles with deadly accuracy.

Mass: 80 tons
Chassis: Alshain Class 92
Power Plant: LTV 400 XL
Cruising Speed: 54 kph
Maximum Speed: 86.4 kph
Jump Jets: Lexington Ltd. Lifters
Jump Capacity: 150 meters

Armor: New Samarkand Royal Ferro-Fibrous with CASE

Armament:
 1 Shigunga LRM-20 Missile Rack
 4 Victory Heartbeat Medium Pulse Lasers

Manufacturer: Luthien Armor Works

Primary Factory: Luthien

Communications System: Sipher Security Plus

Targeting and Tracking System: Cat's Eyes 5 with Artemis
 IV System

Type: **Charger**

Technology Base: Inner Sphere

Tonnage: 80

Equipment		Mass
Internal Structure:		8
Engine:	400 XL	26.5
Walking MP:	5	
Running MP:	8	
Jumping MP:	5	
Heat Sinks:	12 [24]	2
Gyro:		4
Cockpit:		3
Armor Factor:	179	10
	<i>Internal Structure</i>	<i>Armor Value</i>
Head	3	9
Center Torso	25	27
Center Torso (rear)		7
R/L Torso	17	24
R/L Torso (rear)		7
R/L Arm	13	15
R/L Leg	17	22

Weapons and Ammo	Location	Critical	Tonnage
LRM 20	RT	5	10
Artemis IV FCS	RT	1	1
Ammo (LRM) 12	LT	2	2
CASE	LT	1	.5
Medium Pulse Laser	RT	1	2
Medium Pulse Laser	RA	1	2
Medium Pulse Laser	LT	1	2
Medium Pulse Laser	LA	1	2
Jump Jet	CT	1	1
Jump Jets	LL	2	2
Jump Jets	RL	2	2

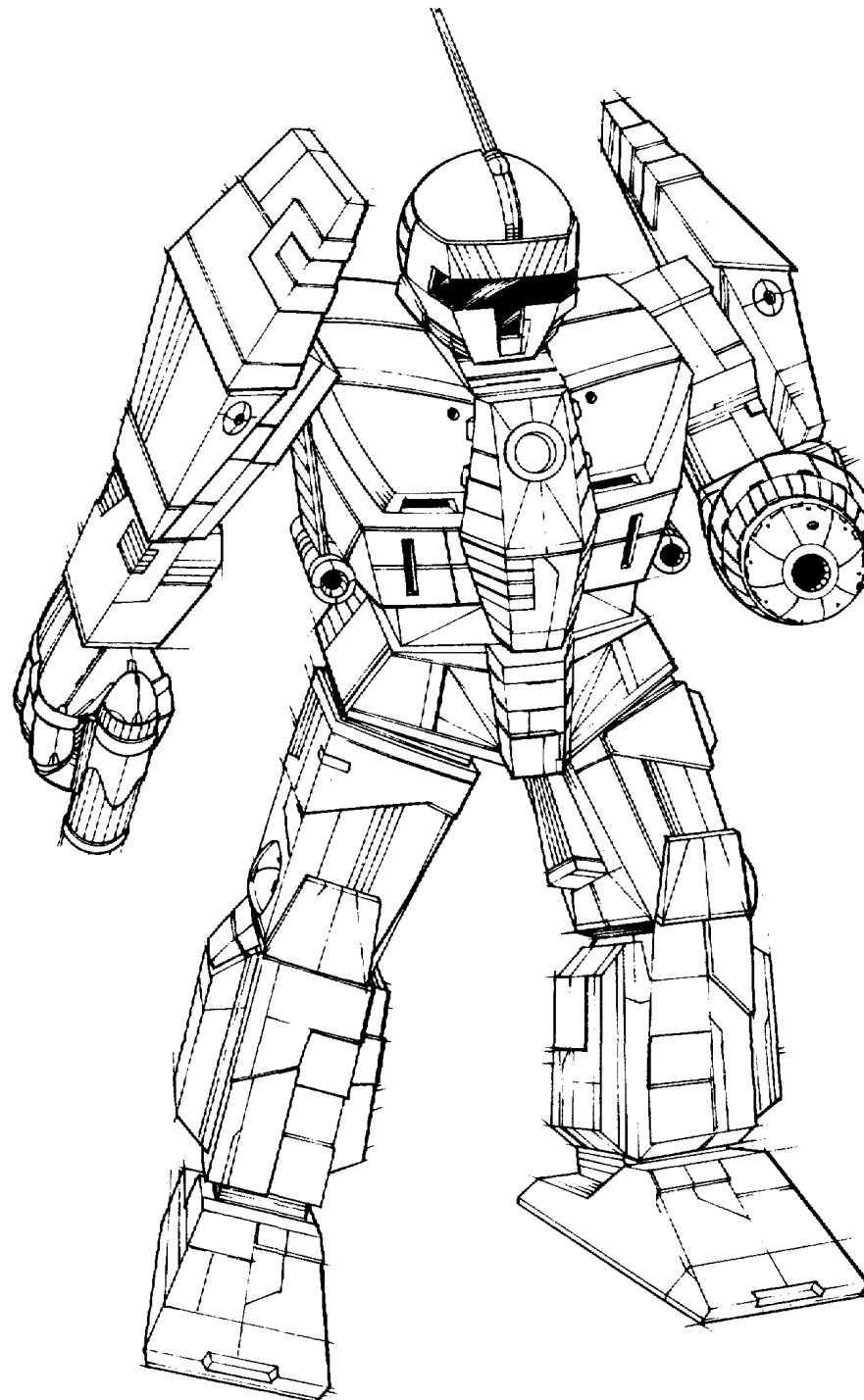



OVERVIEW

The HTM-27T *Hatamoto-Chi* is one of the first BattleMechs fielded by the DCMS using advanced construction materials, most notably an endo-steel chassis and ferro-fibrous armor. First deployed by the DCMS on An Ting in 3039, the *Hatamoto-Chi* is a significant conversion of the Wells Technologies CGR-1A1. The modifications performed by Kurita engineers were so extensive that the 'Mech was given a new designation.

Externally, the *Hatamoto-Chi* is similar to its parent design, retaining the large shoulder assemblies and lacking a left hand, which give the machine its characteristic silhouette. The most obvious distinguishing characteristics of this class are the radiator fins mounted on the center rear torso and head. The rear fin, resembling an ancient samurai's *sashimono* (back banner), is what gives the BattleMech its name.

There are four known variants of the *Hatamoto-Chi*, all of them replacing the SRM weaponry and ammo with other weapons. The *Hatamoto-Hi* variant replaces the SRMs, ammo and CASE system with four medium lasers and one heat sink. The *Hatamoto-Kaze* has two batteries of LRM-5s, as well as four tons of ammunition. The *Hatamoto-Ku* carries a short-barrel Class 5 autocannon with one ton of ammunition, but the ammo is not protected by a CASE system. Finally, the *Hatamoto-Mizo* mounts an extended-range large laser and additional heat sinks.

Mass: 80 tons
Chassis: Earthwerks VOL Endo Steel
Power Plant: Pitban 320
Cruising Speed: 43 kph
Maximum Speed: 65 kph
Jump Jets: None
Jump Capacity: None
Armor: Mitchell Argon with CASE
Armament:
 2 Tiegart PPCs
 2 Bical SRM-6 Missile Racks
Manufacturer: Maltex Corporation
Primary Factory: Errai
Communications System: Colmax 90
Targeting and Tracking System: Garret D2j

Type: **Hatamoto-Chi**
 Technology Base: Inner Sphere
 Tonnage: 80

Equipment		Mass
Internal Structure:	Endo	4
Engine:	320	22.5
Walking MP:	4	
Running MP:	6	
Jumping MP:	0	
Heat Sinks:	18	8
Gyro:		4
Cockpit:		3
Armor Factor:	248	15.5

	Internal Structure	Armor Value
Head	3	9
Center Torso	25	34
Center Torso (rear)		16
R/L Torso	17	25
R/L Torso (rear)		9
R/L Arm	13	26
R/L Leg	17	34

Weapons and Ammo	Location	Critical	Tonnage
PPC	RA	3	7
PPC	LA	3	7
SRM 6	RT	2	3
Ammo (SRM) 15	RT	1	1
CASE	RT	1	.5
SRM 6	LT	2	3
Ammo (SRM) 15	LT	1	1
CASE	LT	1	.5

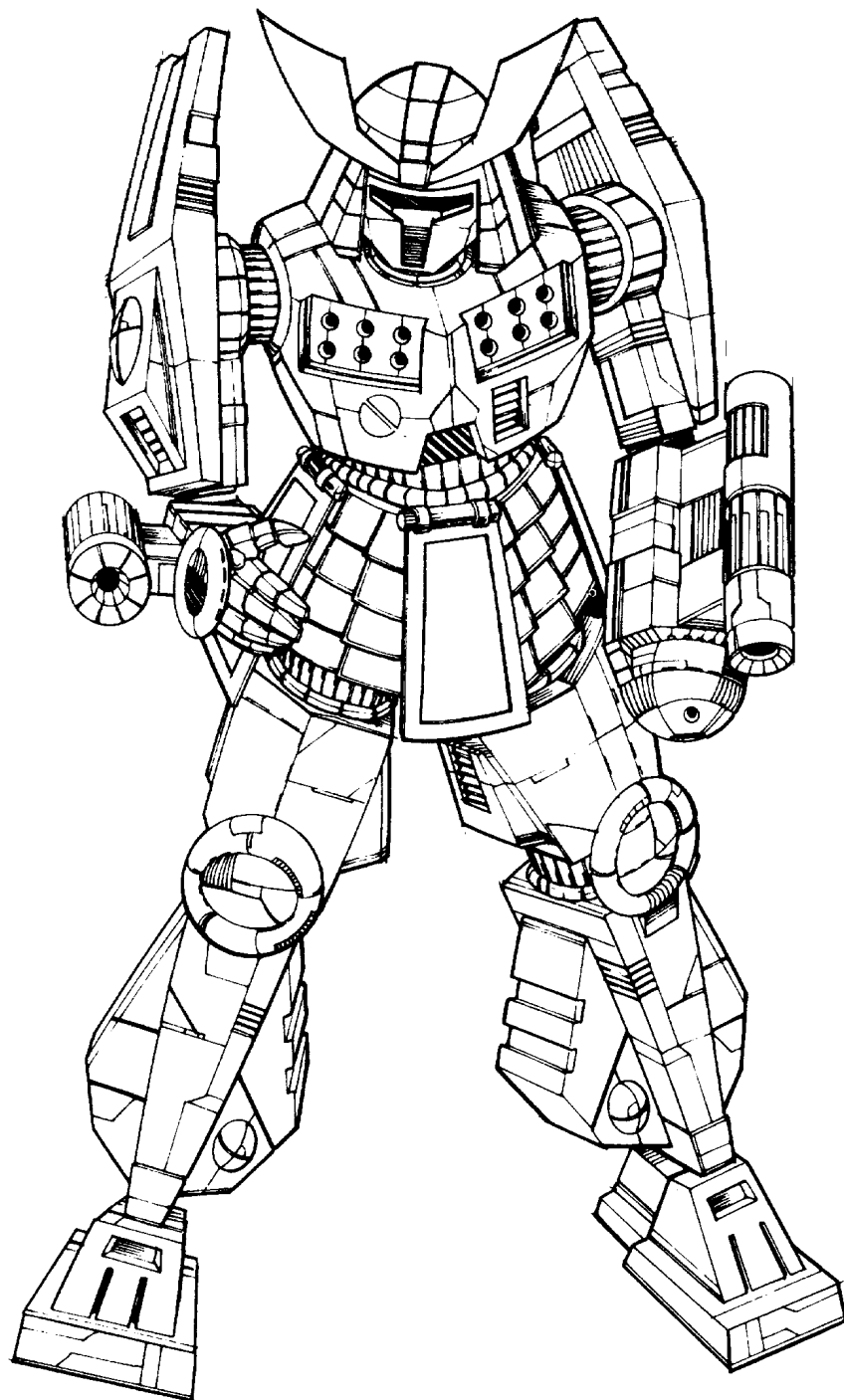



OVERVIEW

Designed in 2572 as a competitor to the popular *Warhammer* BattleMech, the eighty-ton *Thug* has beefed-up armor protection and a more advanced target acquisition system than its predecessor. With a respectable speed of 65 kph, the *Thug* is built on the concept that the best defense is a strong offense.

Its main improvement over the *Warhammer* is the additional tonnage of ferro-fibrous armor, allowing the *Thug* to sustain an attack for a longer period. The *Thug* also avoids some of the *Warhammer's* heat problems by removing secondary energy weapons rather than adding heat sinks.

Twin Tiegart particle projection cannons located in the *Thug's* arms provide the knock-out punch needed by any heavy 'Mech. Though ten percent smaller than the Donal PPCs carried by the *Warhammer*, the Tiegart matches its larger cousin for power and damage. The Tiegart's major drawback is the scarcity of replacement parts. Even though several redundant circuits provide backup power if needed, the MechWarrior's control over the weapon suffers greatly without a steady supply of parts.

Secondary weapons include two Bical-6 short-range missile launchers, one each in the 'Mech's right and left torsos. The SRMs provide short-range firepower and free the *Thug's* arms for hand-to-hand combat. When all four weapons fire at the same target, the effect on the enemy is devastating. Only the strongest 'Mechs can withstand such a massive barrage. The *Thug* is equipped with CASE, safeguarding the MechWarrior from missile-load explosions.

Mass: 80 tons
Chassis: Earthwerks VOL
Power Plant: Pitban 320
Cruising Speed: 43 kph
Maximum Speed: 65 kph
Jump Jets: None
Jump Capacity: None
Armor: Mitchell Argon with CASE
Armament:
 2 Tiegart PPCs
 2 Bical SRM-6 Missile Racks
Manufacturer: Maltex Corporation
Communications System: Colmax 90
Targeting and Tracking System: TharHes Ares-5

Type: Thug
Technology Base: Inner Sphere
Tonnage: 80

Equipment		Mass
Internal Structure:	Endo	4
Engine:	320	22.5
Walking MP:	4	
Running MP:	6	
Jumping MP:	0	
Heat Sinks:	18 [36]	8
Gyro:		4
Cockpit:		3
Armor Factor:	248	15.5
	<i>Internal Structure</i>	<i>Armor Value</i>
Head	3	9
Center Torso	25	34
Center Torso (rear)		16
R/L Torso	17	25
R/L Torso (rear)		9
R/L Arm	13	26
R/L Leg	17	34

Weapons and Ammo	Location	Critical	Tonnage
PPC	RA	3	7
PPC	LA	3	7
SRM 6	RT	2	3
Ammo (SRM) 15	RT	1	1
CASE	RT	1	.5
SRM 6	LT	2	3
Ammo (SRM) 15	LT	1	1
CASE	LT	1	.5

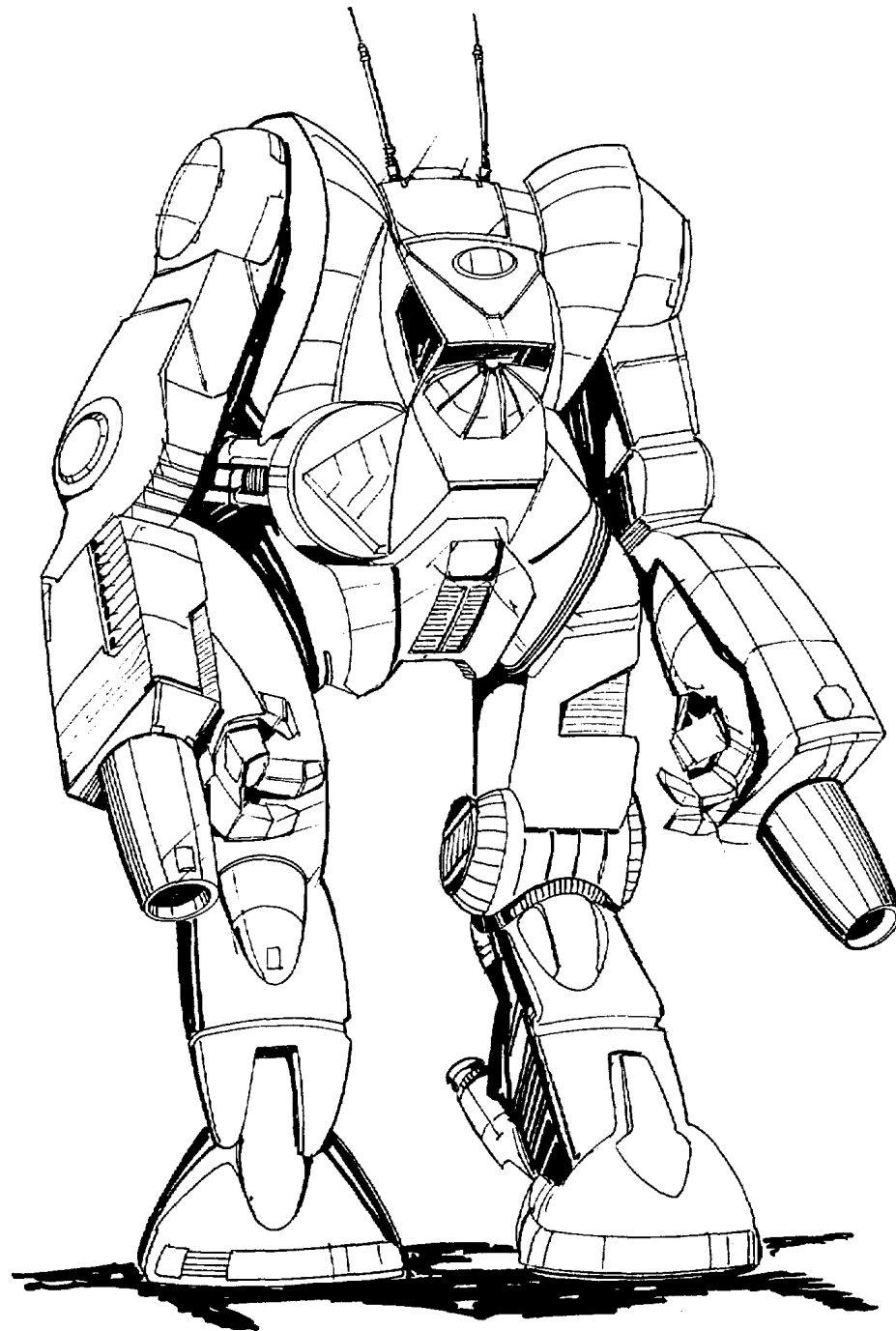

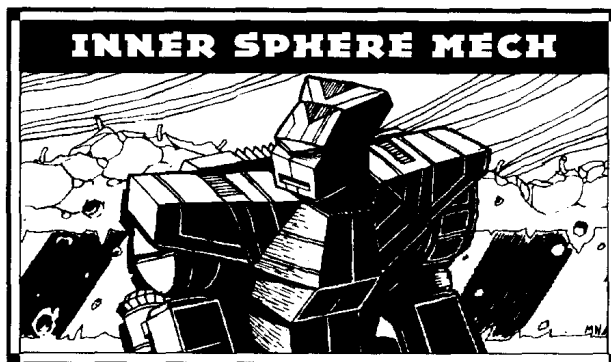

OVERVIEW

This BattleMech, a Federated Commonwealth design with the same name as that realm's heir to the throne, was one of the first to get special priority for increased production and widespread deployment throughout the Federated Commonwealth. It was also an early candidate for recovered Star League-era technology.

It is ironic that the *Victor* is no longer produced in the Federated Commonwealth. Despite all the advance planning, the Draconis Combine captured the world of Quentin in the War of 3039—and with it, Independence Weaponry, the Federated Commonwealth's only producer of the *Victor*. House Kurita now produces the upgraded design for its own regiments, and the Federated Commonwealth has been reduced to purchasing the entire output of the HildCo Interplanetary factory in the St. Ives Compact.

The new model VTR-9K employs endo steel in its internal structure, which lightens the weight enough to accommodate upgraded weapons. The original *Victor's* two medium lasers have been replaced with pulse technology, and the 'Mech sports a mammoth Gauss rifle in place of an AC/20. Cellular Ammunition Storage Equipment protects the Gauss rifle's ample supply of ammunition.

Mass: 80 tons
Chassis: Alshain Class 920 Endo Steel
Power Plant: Pitban 320
Cruising Speed: 43.2 kph
Maximum Speed: 64.8 kph
Jump Jets: Lexington Ltd. Lifters
Jump Capacity: 120 meters
Armor: Durallex Heavy with CASE

Armament:
 1 Dragon's Fire Gauss Rifle
 2 Victory Heartbeat Medium Pulse Lasers
 1 Telos SRM-4 Missile Rack

Manufacturer: Independence Weaponry, HildCo Interplanetary
Primary Factory: Quentin (Independence), St. Ives (HildCo)

Communications System: Sipher Security Plus
Targeting and Tracking System: Matabushi Sentinel

Type: **Victor**
 Technology Base: Inner Sphere
 Tonnage: 80

Equipment		Mass
Internal Structure:	Endo	4
Engine:	320	22.5
Walking MP:	4	
Running MP:	6	
Jumping MP:	4	
Heat Sinks:	15	5
Gyro:		4
Cockpit:		3
Armor Factor:	200	12.5

	Internal Structure	Armor Value
Head	3	9
Center Torso	25	34
Center Torso (rear)		15
R/L Torso	17	23
R/L Torso (rear)		10
R/L Arm	13	18
R/L Leg	17	20

Weapons and Ammo	Location	Critical	Tonnage
Gauss Rifle	RA	7	15
Ammo (Gauss) 16	RT	2	2
CASE	RT	1	.5
Medium Pulse Laser	LA	1	2
Medium Pulse Laser	LA	1	2
SRM 4	LT	1	2
Ammo (SRM) 25	LT	1	1
CASE	LT	1	.5
Jump Jets	CT	2	2
Jump Jet	RL	1	1
Jump Jet	LL	1	1

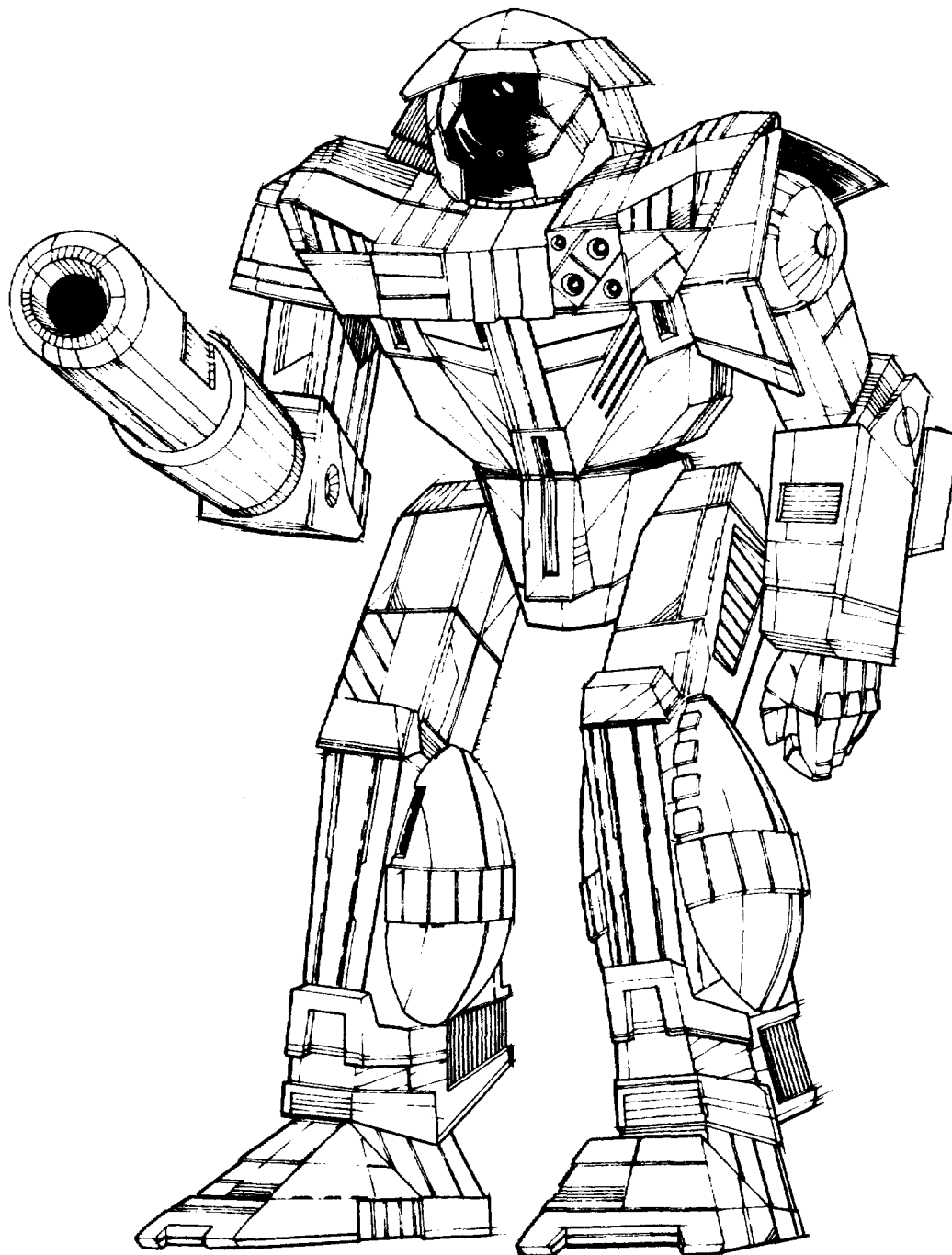



OVERVIEW

The merger of the Lyran Commonwealth with the Federated Suns has given the Federated Commonwealth Armed Forces something of a Davion flavor. Davion tactics predominate, and Davion military organization has been superimposed on Steiner units. Along with many Davion ways of doing things came an emphasis on 'Mech designs in favor with the Armed Forces of the Federated Suns. However, the pride of the Lyran Commonwealth—the *Zeus*—was too valuable to be ignored. Procurement officers prodded Defiance Industries of Hesperus to speed up its production, sending the new 'Mechs to corners of Davion space that had rarely seen this design.

The availability of Star League-era technology presents new opportunities for tacticians to use the *Zeus*. Though security on Hesperus is extremely tight, ComStar has received reliable reports of a new model, the ZEU-9S.

The new *Zeus* uses Glasgow Limited Primo ferro-fibrous armor, which offers better protection for less weight. The savings in weight allows the design to incorporate Cellular Ammunition Storage Equipment to guard against an internal explosion, and also allows it to carry improved weapons. The new *Zeus* employs double heat sinks, which enable it to handle the increased heat that the new weapons generate. An extended-range Defiance 1001 particle projection cannon replaces the aging autocannon in the 'Mech's left arm. Designers upgraded the large laser in the left torso to a Cyclops XII extended-range model and replaced both medium lasers with pulse-model Defiance P5Ms.

Mass: 80 tons
Chassis: Chariot Type III
Power Plant: Pitban 320
Cruising Speed: 43.2 kph
Maximum Speed: 64.8 kph
Jump Jets: None
Jump Capacity: None
Armor: Glasgow Limited Primo Ferro-Fibrous with CASE
Armament:
 1 Defiance 1001 PPC
 1 Cyclops XII Extended-Range Large Laser
 1 Coventry Starfire LRM-15 Missile Rack
 2 Defiance P5M Medium Pulse Lasers
Manufacturer: Defiance Industries
Primary Factory: Hesperus
Communications System: TharHes Calliope ZE-2
Targeting and Tracking System: TharHes Ares-7

Type: Zeus
Technology Base: Inner Sphere
Tonnage: 80

Equipment		Mass
Internal Structure:		8
Engine:	320	22.5
Walking MP:	4	
Running MP:	6	
Jumping MP:	0	
Heat Sinks:	17 [34]	7
Gyro:		4
Cockpit:		3
Armor Factor:	197	11

	Internal Structure	Armor Value
Head	3	9
Center Torso	25	26
Center Torso (rear)		8
R/L Torso	17	25
R/L Torso (rear)		6
R/L Arm	13	22
R/L Leg	17	24

Weapons and Ammo	Location	Critical	Tonnage
ER PPC	LA	3	7
ER Large Laser	LT	2	5
LRM 15	RA	3	7
Ammo (LRM) 8	RT	1	1
CASE	RT	1	.5
Medium Pulse Laser	CT	1	2
Medium Pulse Laser	LT (R)	1	2

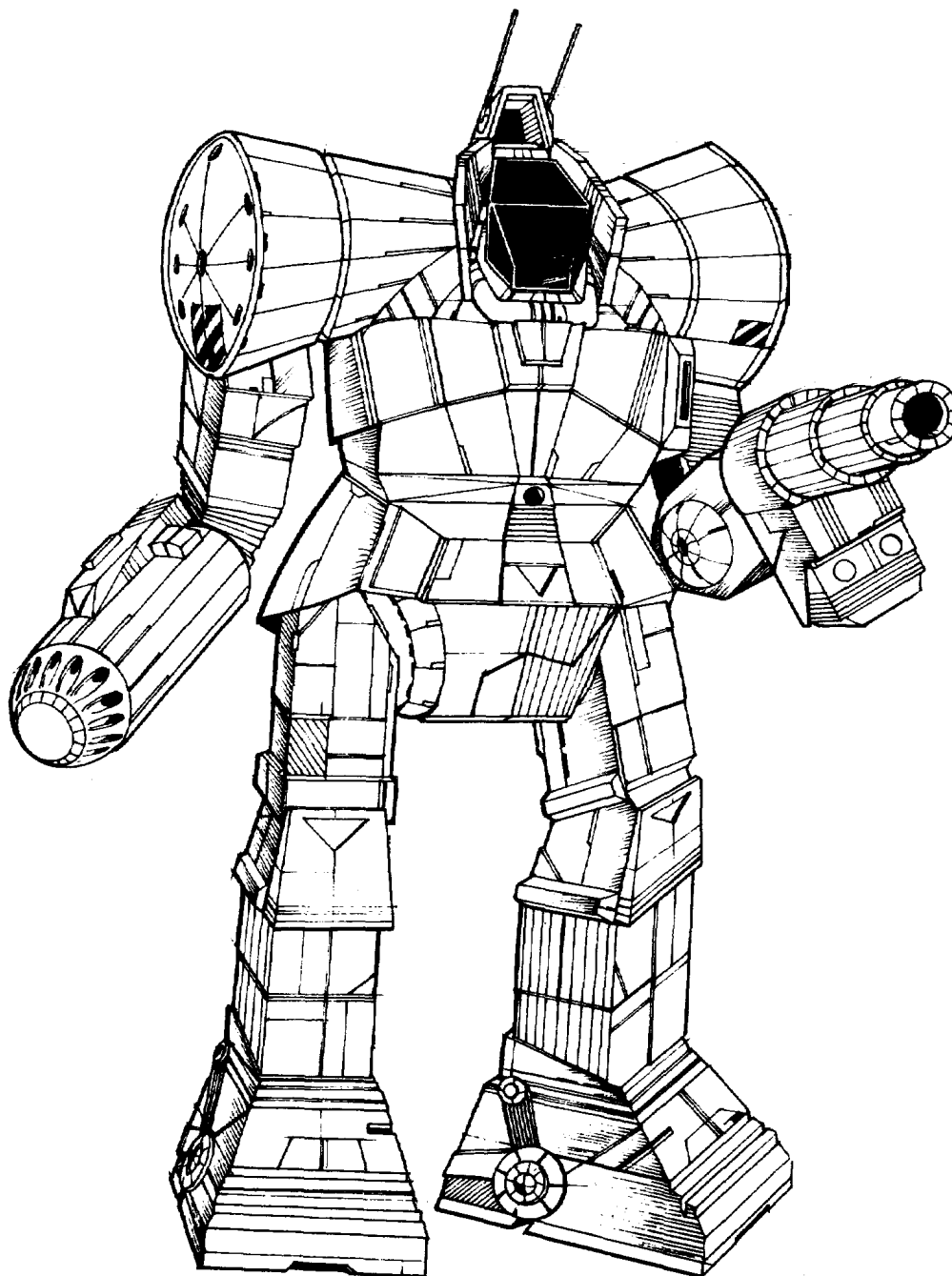



OVERVIEW

The *Katana* is based on an earlier design produced by Blankenburg Technologies—the *Crockett*, first built in 2735. The *Katana* is yet another BattleMech given to the Draconis Combine Mustered Soldiery by ComStar, and the 'Mech enjoyed great success in the War of 3039 even though the Combine's model is not quite the equal of the *Crockett* deployed by the Com Guards. In the past decade, the Successor States have begun to unlock the Star League's technological secrets in a way that ComStar could not have foreseen, and so the *Katana* may soon match its predecessor in technological sophistication.

The *Katana* differs from the *Crockett* in two ways: it has no double heat sinks, and it uses common Magna Mark III large lasers in place of the *Crockett's* extended-range Blankenburg 25 lasers. ROM agents have been unable to learn the extent to which existing *Katanas* have been retrofitted with more advanced systems.

CRK-5003-2 KATANA

Mass: 85 tons
Chassis: Geometric 530 Hard Core
Power Plant: Strand 255
Cruising Speed: 32 kph
Maximum Speed: 54 kph
Jump Jets: Geotec 300
Jump Capacity: 90 meters
Armor: CarboStrand 30 Weight AS
Armament:
 2 Magna Mark III Large Lasers
 2 Holly SRM-6 Missile Racks
 1 Blankenburg LB 10-X Autocannon
 2 Dodd Small Lasers
Manufacturer: Blankenburg Technologies
Primary Factory: Soul
Communications System: GRPNTR Groundpainter 5
Targeting and Tracking System: Scope 30 RNDST

Type: **Katana**
 Technology Base: Inner Sphere
 Tonnage: 85

Equipment
Mass
 Internal Structure: 8.5
 Engine: 255 13
 Walking MP: 3
 Running MP: 5
 Jumping MP: 3
 Heat Sinks: 20 10
 Gyro: 3
 Cockpit: 3
 Armor Factor: 200 12.5

	Internal Structure	Armor Value
Head	3	9
Center Torso	27	31
Center Torso (rear)		12
R/L Torso	18	23
R/L Torso (rear)		8
R/L Arm	14	19
R/L Leg	18	24

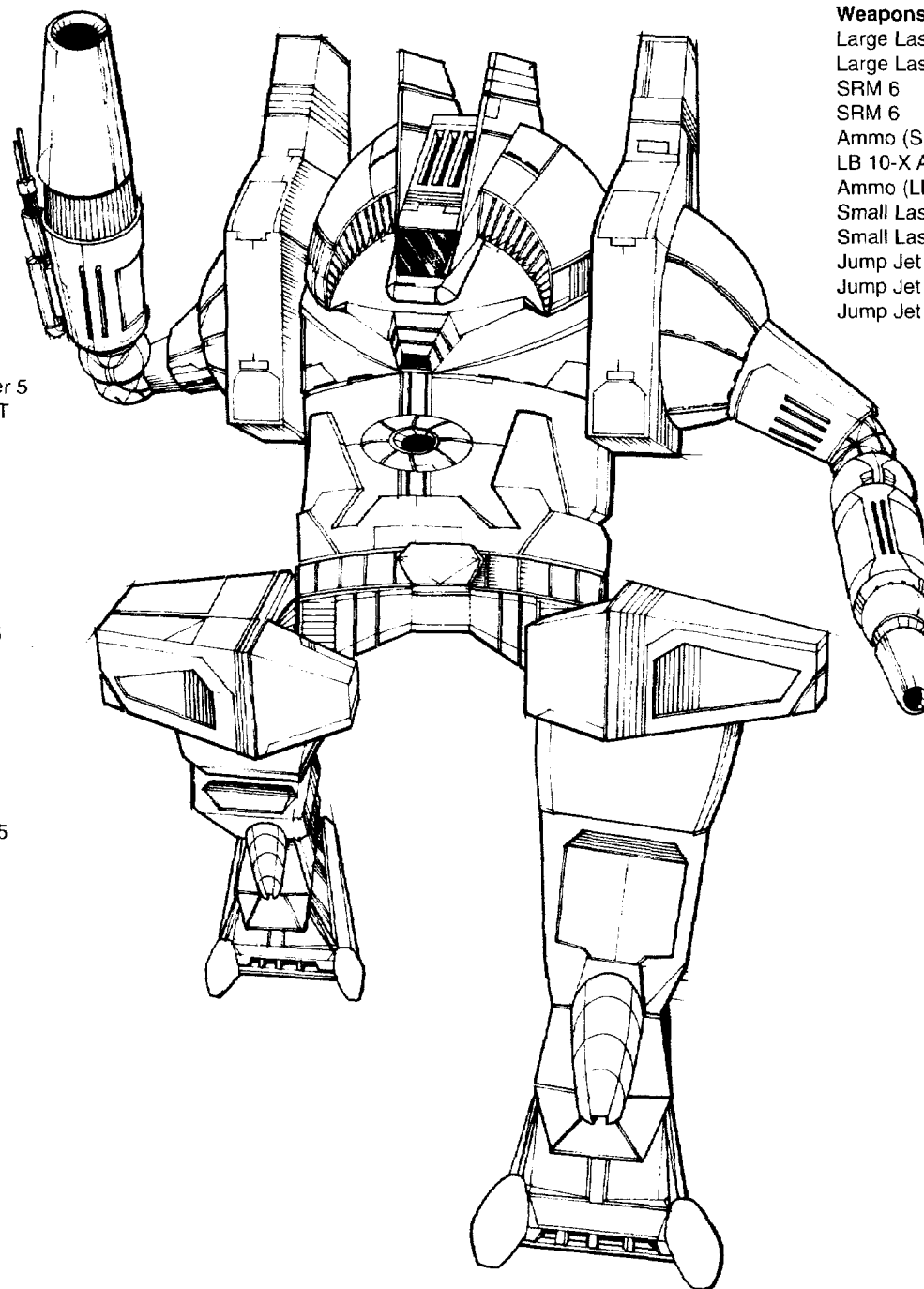

Weapons and Ammo	Location	Critical	Tonnage
Large Laser	RA	2	5
Large Laser	LA	2	5
SRM 6	RT	2	3
SRM 6	LT	2	3
Ammo (SRM) 30	RT	2	2
LB 10-X AC	LT	6	11
Ammo (LB-X) 20	RT	2	2
Small Laser	RA	1	.5
Small Laser	LA	1	.5
Jump Jet	RL	1	1
Jump Jet	LL	1	1
Jump Jet	CT	1	1



OVERVIEW

Appearing frequently only in Zeta Battalion of the mercenary unit Wolf's Dragoons, the *Shogun* is uncommon in the other Dragoon regiments and almost unknown in the armies of the Successor States. Zeta Battalion's fearless fighting style cost them quite a few *Shoguns* in the decades prior to the Fourth Succession War, and the heavy losses suffered by the Dragoons in the shootout on Misery and in the Fourth Succession War almost made the *Shogun* an extinct 'Mech. Because security is so tight on Outreach, the home base of Wolf's Dragoons, ComStar has been unable to formulate reliable estimates of the number of surviving *Shoguns*. Unless the Dragoons have a source of new 'Mechs, however, the number cannot be very high.

Though anticipating field modifications takes the analysis process into pure speculation, ComStar's military experts believe that the Dragoons are unlikely to make any changes to the *Shogun* that would require the removal of its jump jets. They are likely, however, to substitute the commonly available Magna Firestar extended-range particle projection cannon for the older Magna Hellstar version.

Mass: 85 tons
Chassis: Kitushi Shogun
Power Plant: Strand 255
Cruising Speed: 32 kph
Maximum Speed: 54 kph
Jump Jets: Anderson Propulsion 21
 Jump Capacity: 90 meters
Armor: Riese-350
Armament:
 1 Magna Firestar Extended Range PPC
 2 Thunderstroke SRM-6 Missile Racks
 2 Coventry Starfire LRM-15 Missile Racks
Manufacturer: Mitchell Vehicles
 Primary Factory: Graham IV
Communications System: HartfordCo COM 4000
Targeting and Tracking System: HartfordCo XKZ 1

Weapons and Ammo	Location	Critical	Tonnage
SRM 6	RT	2	3
Ammo (SRM) 15	RT	1	1
CASE	RT	1	.5
SRM 6	LT	2	3
Ammo (SRM) 15	LT	1	1
CASE	LT	1	.5
LRM 15	LA	3	7
Ammo (LRM) 8	LT	1	1
LRM 15	RA	3	7
Ammo (LRM) 8	RT	1	1
ER PPC	RT	3	7
Jump Jet	LL	1	1
Jump Jet	RL	1	1
Jump Jet	CT	1	1

Type: Shogun
Technology Base: Inner Sphere
Tonnage: 85

Equipment		Mass
Internal Structure:		8.5
Engine:	255	13
Walking MP:	3	
Running MP:	5	
Jumping MP:	3	
Heat Sinks:	17	7
Gyro:		3
Cockpit:		3
Armor Factor:	248	15.5
	<i>Internal Structure</i>	<i>Armor Value</i>
Head	3	9
Center Torso	27	40
Center Torso (rear)		11
R/L Torso	18	28
R/L Torso (rear)		8
R/L Arm	14	22
R/L Leg	18	36

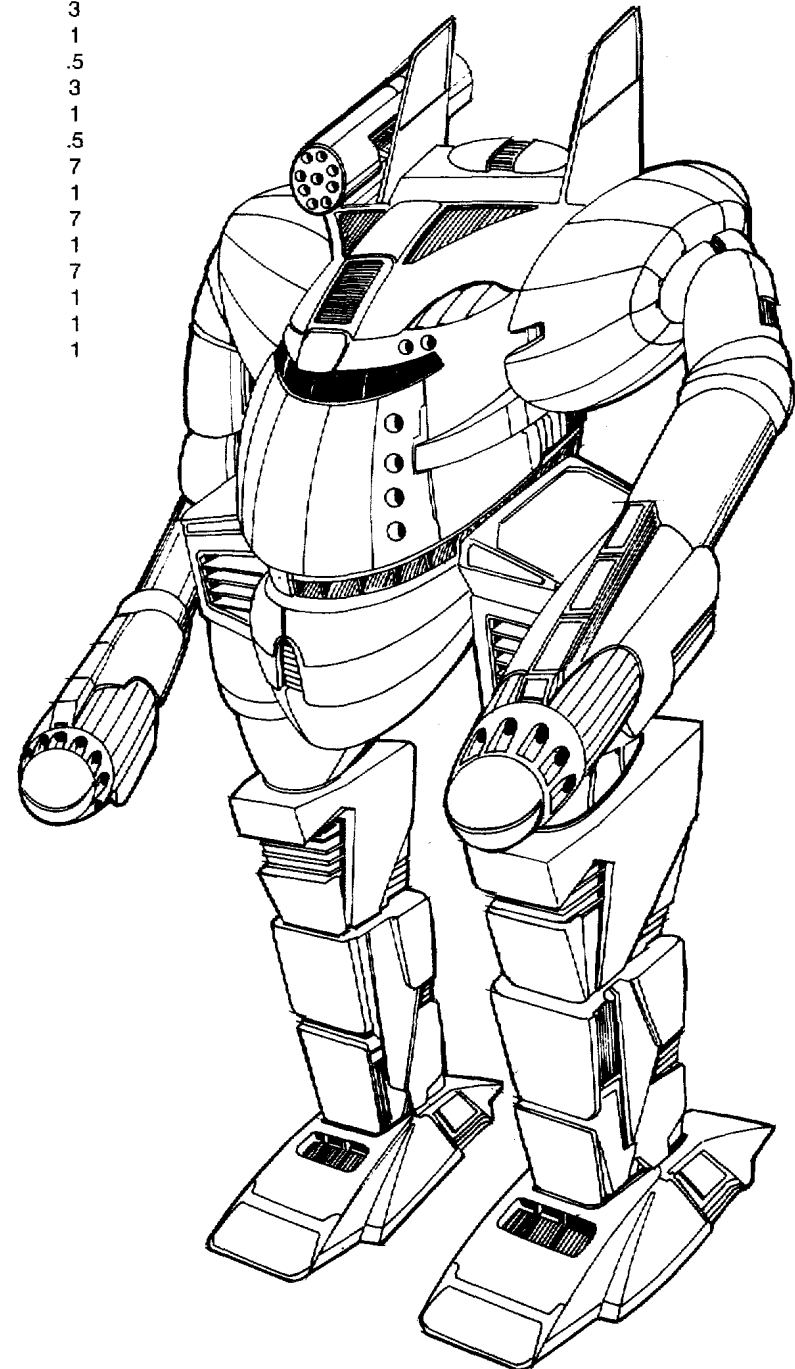



OVERVIEW

A popular and common design, the *Stalker* is being upgraded with the Star League technology currently being incorporated into other Successor State 'Mech designs. The most promising version appears to be the model nearing production in the Free Worlds League.

Irian BattleMechs Unlimited has almost finished retooling its plant on Shiro III to produce the STK-5M *Stalker*. This redesign attempts to address the *Stalker's* heat problems by using double heat sinks. Though the final model carries three fewer sinks than its predecessor, their double configuration allows them to dissipate much more heat than the original heat sinks. This model also carries the advanced Octagon Missile-Magnet Narc missile beacon, greatly improving the accuracy of its missiles and those of its lancemates. The STK-5M replaces the original's pair of Magna large lasers with a single Diverse Optics Sunbeam extended-range large laser and adds a ton of armor for greater protection.

The STK-5S version planned by the Federated Commonwealth is further from fruition and looks likely to have many more problems. Scheduled for the Trelshire Heavy Industries factory on Twycross, this version adds advanced weapons but does nothing to dissipate the additional heat they will generate. Mounting an Edasich Motors 255 XL engine but keeping the original heat sinks and armor, this *Stalker* will force its pilots to keep a sharp eye on the heat gauge. It lacks the sophisticated Narc missile beacon, but has other sophisticated systems. Two Thunderbolt-12 large pulse lasers replace the Magna Mark III large lasers. A Deprus Swarmshot anti-missile system and Cellular Ammunition Storage Equipment provide extra protection.

Mass: 85 tons
Chassis: Irian Chassis Class 30
Power Plant: Strand 255
Cruising Speed: 32.4 kph
Maximum Speed: 54 kph
Jump Jets: None

Jump Capacity: None

Armor: Riese-456

Armament:

- 2 Irian Weapons Works LRM-10 Missile Racks
- 1 Diverse Optics Sunbeam Extended Range Large Laser
- 2 Irian Weapons Works SRM-6 Missile Racks
- 1 Octagon Missile-Magnet Narc Beacon
- 4 Magna Mark II Medium Lasers

Manufacturer: Irian BattleMechs Unlimited

Primary Factory: Shiro III

Communications System: Irian E.A.R.

Targeting and Tracking System: Wasat Aggressor

Type: Stalker

Technology Base: Inner Sphere

Tonnage: 85

Equipment		Mass
Internal Structure:		8.5
Engine:	255	13
Walking MP:	3	
Running MP:	5	
Jumping MP:	0	
Heat Sinks:	17 [34]	7
Gyro:		3
Cockpit:		3
Armor Factor:	232	14.5
	<i>Internal Structure</i>	<i>Armor Value</i>
Head	3	9
Center Torso	27	36
Center Torso (rear)		11
R/L Torso	18	27
R/L Torso (rear)		9
R/L Arm	14	25
R/L Leg	18	27

Weapons and Ammo	Location	Critical	Tonnage
LRM 10	RA	2	5
Ammo (LRM) 24	RA	2	2
LRM 10	LA	2	5
Ammo (LRM) 24	LA	2	2
ER Large Laser	CT	2	5
SRM 6	RT	2	3
Ammo (SRM) 15	RT	1	1
SRM 6	LT	2	3
Ammo (SRM) 15	LT	1	1
Narc Missile Beacon	LT	2	3
Ammo (Narc) 12	LL	2	2
Medium Laser	RA	1	1
Medium Laser	RA	1	1
Medium Laser	LA	1	1
Medium Laser	LA	1	1

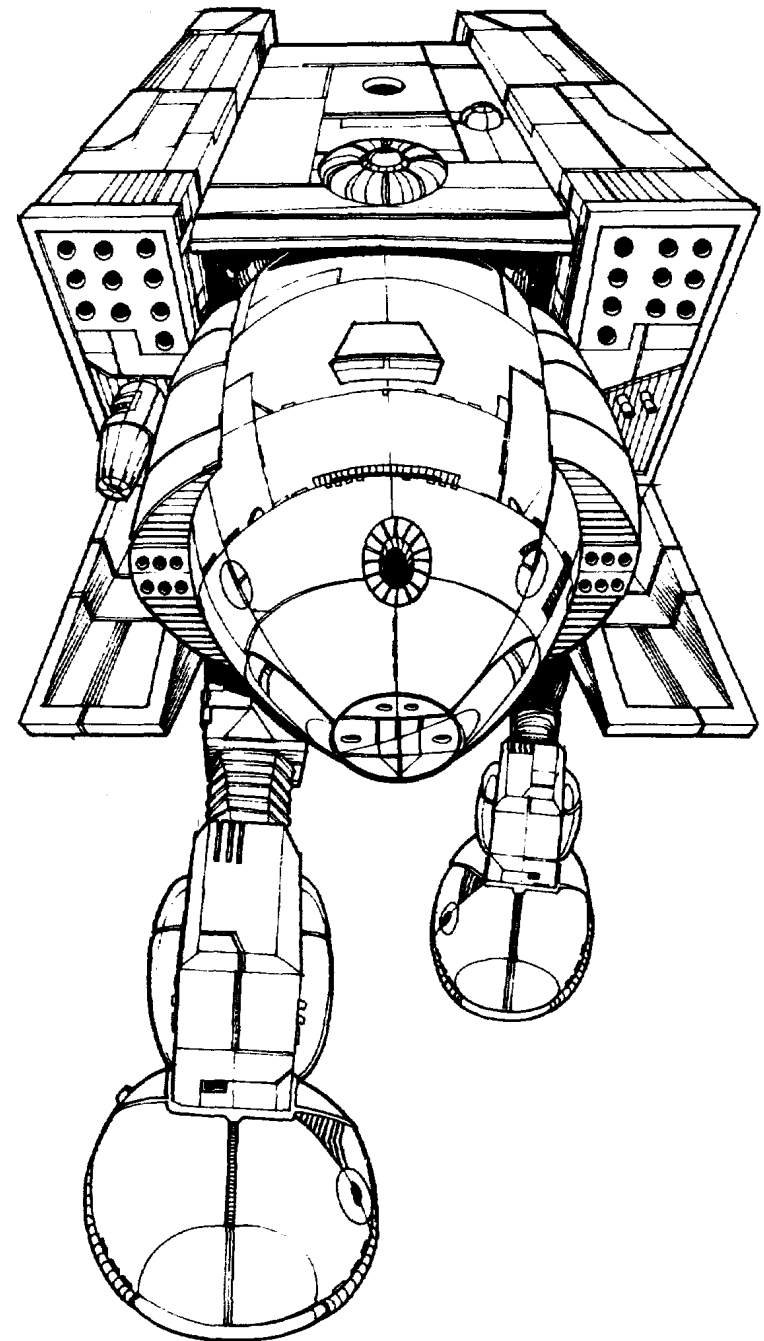



OVERVIEW

Although the battles of the Succession Wars greatly reduced the number of *Cyclops*, the design is still employed in a variety of roles throughout the Inner Sphere. Although no manufacturer currently produces a standard field-modification kit for the *Cyclops*, unit commanders and their technicians have modified these BattleMechs in numerous ways. Most commonly, MechWarriors replace the original design's Zeus-36 Mark III autocannon with Zeus Slingshot Gauss rifles. Although the Gauss rifle does slightly less damage than the Mark III autocannon, it possesses a greater range and produces less heat.

Many MechWarriors also modify the *Cyclops* by installing more sophisticated command and control equipment. Typically, the *Cyclops* is fitted with a command/control/communications (C³) computer. Such computers provide superior communications capacity and other important advantages on the battlefield. For example, all the 'Mechs in a network of C³-equipped 'Mechs can use the targeting data supplied by the sensors of any other 'Mech in the network.

Mass: 90 tons
Chassis: Stormvanger HV-7
Power Plant: Hermes 360
Cruising Speed: 42.1 kph
Maximum Speed: 64.8 kph
Jump Jets: None
Jump Capacity: None
Armor: Starshield Special
Armament:
 1 Zeus Slingshot Gauss Rifle
 1 Delta Dart LRM-10 Missile Rack
 1 Hovertec SRM-4 Missile Rack
 2 Diverse Optics Type 20 Medium Lasers
Manufacturer: Stormvanger Assemblies Unlimited
Primary Factory: Caph
Communications System: Olmstead 840 with SatNav Module
Targeting and Tracking System: Tacticon Tracer 280

Type: **Cyclops**
 Technology Base: Inner Sphere
 Tonnage: 90

Equipment		Mass
Internal Structure:		9
Engine:	360	33
Walking MP:	4	
Running MP:	6	
Jumping MP:	0	
Heat Sinks:	12	2
Gyro:		4
Cockpit:		3
Armor Factor:	160	10
	<i>Internal Structure</i>	<i>Armor Value</i>
Head	3	9
Center Torso	29	30
Center Torso (rear)		11
R/L Torso	19	20
R/L Torso (rear)		8
R/L Arm	15	10
R/L Leg	19	17

Weapons and Ammo	Location	Critical	Tonnage
Gauss Rifle	RT	7	15
Ammo (Gauss) 16	RT	2	2
LRM 10	LT	2	5
Ammo (LRM) 24	LT	2	2
SRM 4	CT	1	2
Ammo (SRM) 25	CT	1	1
Medium Laser	RA	1	1
Medium Laser	RA	1	1

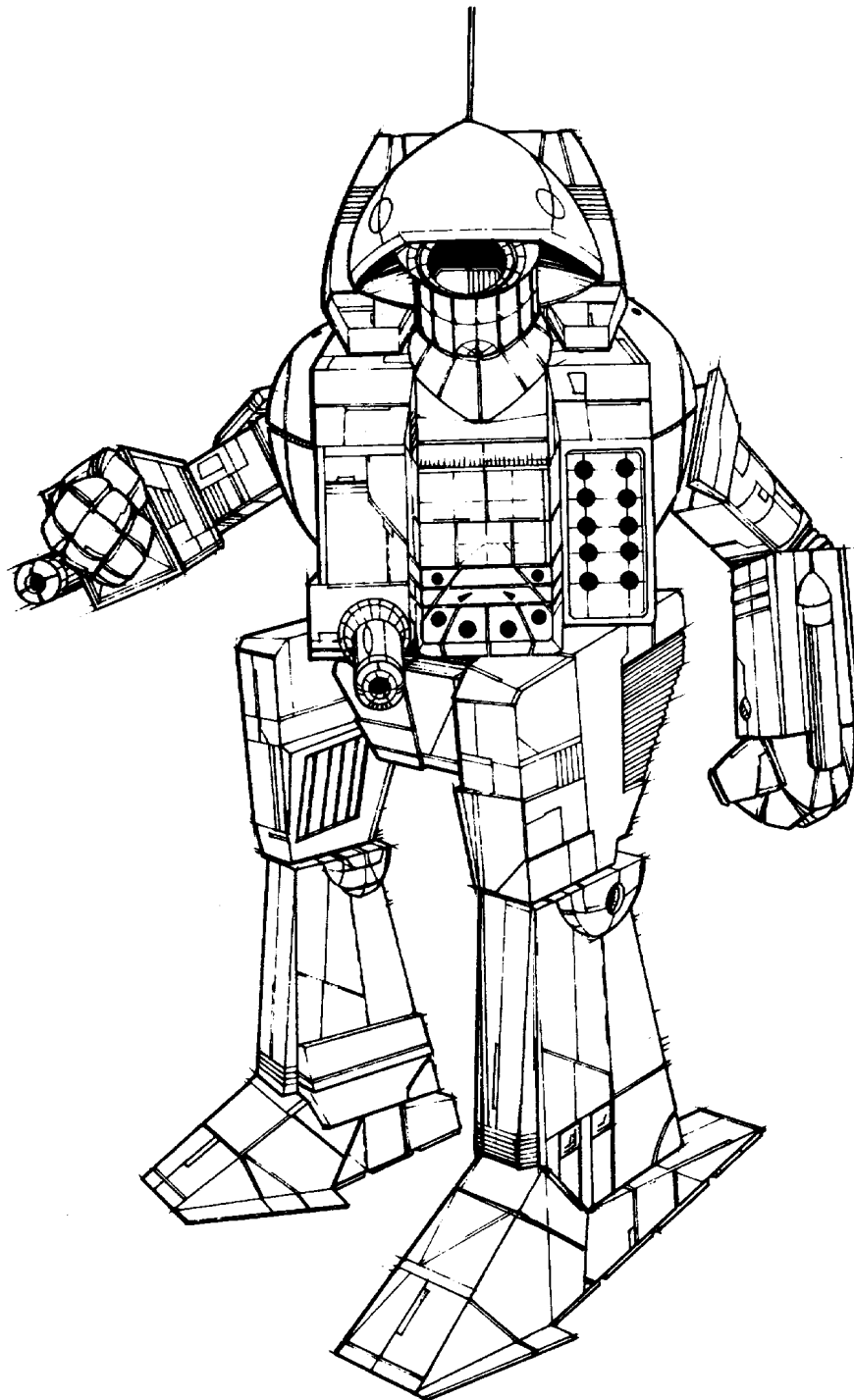



OVERVIEW

A multiple-purpose assault 'Mech with a variety of capabilities, the ninety-ton *Highlander* was assigned to nearly every Star League Army unit soon after its introduction in 2592. Though slow-moving with a maximum speed of 54 kph, the *Highlander* can jump up to ninety meters, easily clearing almost any obstacle. In doing so the 'Mech causes considerable damage to the terrain around its lift-off point. In addition to its jump capability, the *Highlander* carries fifteen and a half tons of Grumman-3 ferro-fibrous armor and has Cellular Ammunition Storage Equipment, plus an impressive array of weapons.

The vehicle's major claim to fame is the "*Highlander Burial*," a maneuver in which a light 'Mech is literally driven into the earth by the force of the *Highlander's* landing on top of it. The *Highlander's* designers assumed that some pilots would try to use its jump capability to land on another 'Mech, and so they gave the *Highlander* impressively thick leg armor and a strengthened interior skeleton in its feet and lower legs to absorb the impact of landings. The jump jets were also designed to allow a pilot to automatically redirect the force of his jets to compensate for landing on a moving foe.

The 'Mech's primary weapon is the Gauss rifle, which uses a series of magnets to propel the shell through the barrel toward the target. The system requires large amounts of power to magnetize the projectile coils, but produces very little heat. The system is quite heavy, however, as it must be heavily protected. A pair of Holly missile launchers, both long- and short-range, and torso-mounted twin Harmon Starclass medium lasers support the Gauss rifle. The missile launchers provide a mix of firepower at every range, and the medium lasers permit the *Highlander* to engage in hand-to-hand combat with both hands free. According to its opponents, the *Highlander's* greatest disadvantage is its need for almost constant ammunition resupply and a lack of significant energy weapons.

HGN-732 HIGHLANDER

Mass: 90 tons
Chassis: Star League XT
Power Plant: GM 270
Cruising Speed: 32 kph
Maximum Speed: 54 kph
Jump Jets: HildCo Model 10
Jump Capacity: 90 meters

Armor: Grumman-3 Ferro-Fibrous with CASE

Armament:
 1 M-7 Gauss Rifle
 1 Holly LRM-20 Missile Rack
 1 Holly SRM-6 Missile Rack
 2 Harmon Starclass Medium Lasers

Manufacturer: StarCorp Industries

Communications System: Hector VII

Targeting and Tracking System: Starlight LX-1

Type: **Highlander**
 Technology Base: Inner Sphere
 Tonnage: 90

Equipment		Mass
Internal Structure:		9
Engine:		14.5
Walking MP:	270	
Running MP:	3	
Jumping MP:	5	
Heat Sinks:	12	2
Gyro:		3
Cockpit:		3
Armor Factor:	278	15.5
	<i>Internal Structure</i>	<i>Armor Value</i>
Head	3	9
Center Torso	29	40
Center Torso (rear)		17
R/L Torso	19	28
R/L Torso (rear)		10
R/L Arm	15	30
R/L Leg	19	38

Weapons and Ammo	Location	Critical	Tonnage
Gauss Rifle	RA	7	15
Ammo (Gauss) 16	RT	2	2
CASE	RT	1	.5
LRM 20	LT	5	10
Ammo (LRM) 12	LT	2	2
SRM 6	LA	2	3
Ammo (SRM) 30	LT	2	2
CASE	LT	1	.5
Medium Laser	RT	1	1
Medium Laser	RT	1	1
Jump Jet	CT	1	2
Jump Jet	LT	1	2
Jump Jet	RT	1	2

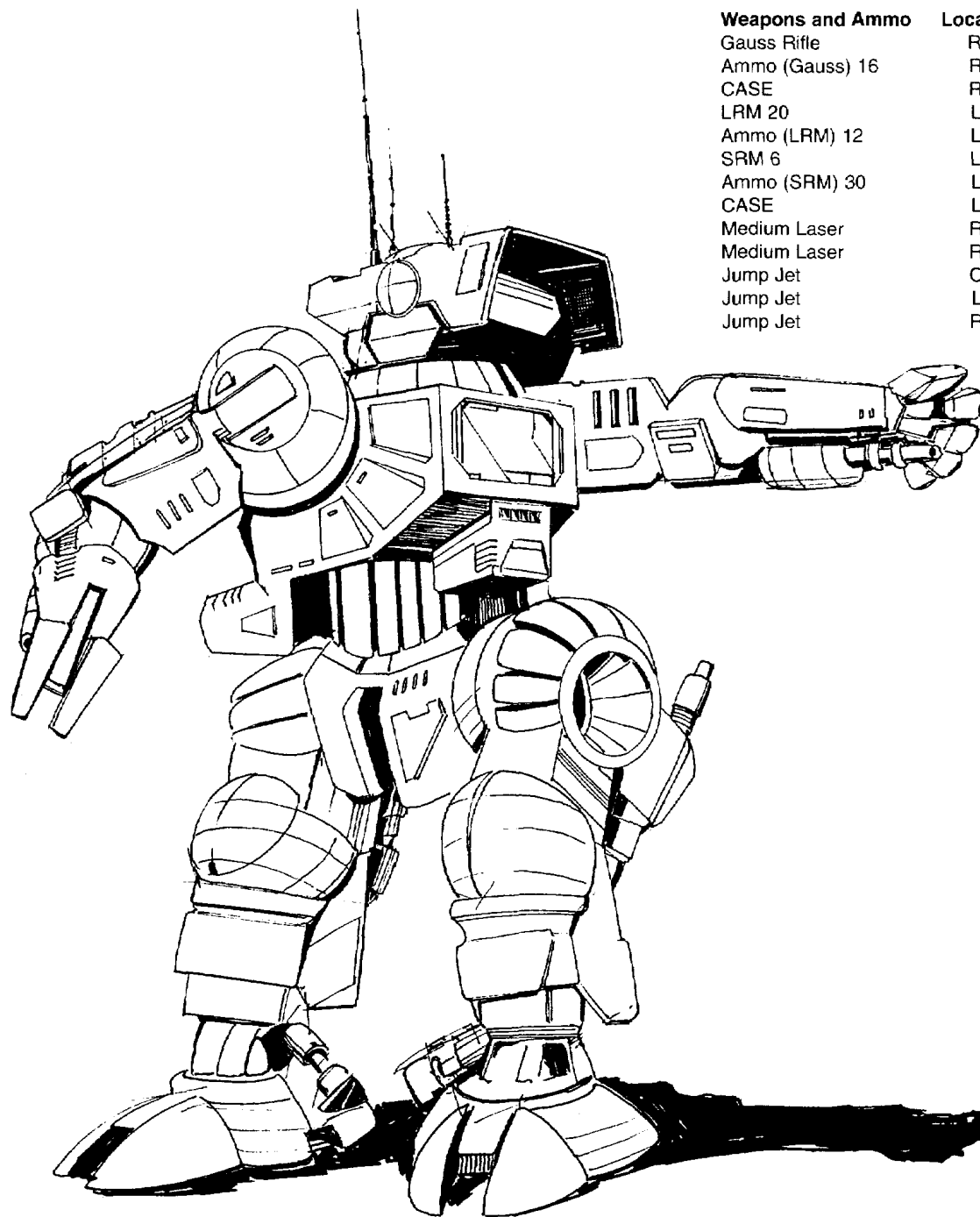



OVERVIEW

The *Mauler* is the Federated Commonwealth code name for an assault 'Mech the DCMS has just begun testing at the proving grounds of Luthien Armor Works. The Draconis Combine has maintained high security around the project, and all available information about the design has been culled from unconfirmed reports, speculation and analysis.

According to the most recent intelligence, the *Mauler* is a slow but advanced design that features an extra-light engine, ferro-fibrous armor, and double heat sinks. Several prototypes have been observed, but no one has yet been able to perform a detailed study of the 'Mech.

Despite these limitations, analysts have determined that the MAL-1R model employs double arm-mounted Victory Nickel Alloy extended-range large lasers, two pairs of torso-mounted Imperator Smoothie-2 autocannons, two torso-mounted Shigunga long-range missile racks, and Cellular Ammunition-Storage Equipment for its missile reloads.

Mass: 90 tons
Chassis: Alshain Class 101
Power Plant: GM 270 XL
Cruising Speed: 32.4 kph
Maximum Speed: 54 kph
Jump Jets: None
Jump Capacity: None
Armor: New Samarkand Royal Ferro-Fibrous with CASE
Armament:
 2 Victory Nickel Alloy Extended Range Large Lasers
 2 Shigunga LRM-15 Missile Racks
 4 Imperator Smoothie-2 Autocannons
Manufacturer: Luthien Armor Works
Primary Factory: Luthien
Communications System: Sipher Security Plus
Targeting and Tracking System: Matabushi Sentinel

Type: Mauler
Technology Base: Inner Sphere
Tonnage: 90

Equipment		Mass
Internal Structure:		9
Engine:	270 XL	7.5
Walking MP:	3	
Running MP:	5	
Jumping MP:	0	
Heat Sinks:	11 [22]	1
Gyro:		3
Cockpit:		3
Armor Factor:	206	11.5
	<i>Internal Structure</i>	<i>Armor Value</i>
Head	3	9
Center Torso	29	27
Center Torso (rear)		10
R/L Torso	19	26
R/L Torso (rear)		10
R/L Arm	15	22
R/L Leg	19	22

Weapons and Ammo	Location	Critical	Tonnage
ER Large Laser	RA	2	5
ER Large Laser	LA	2	5
LRM 15	RT	3	7
Ammo (LRM) 16	RT	2	2
CASE	RT	1	.5
LRM 15	LT	3	7
Ammo (LRM) 16	LT	2	2
CASE	LT	1	.5

Weapons and Ammo	Location	Critical	Tonnage
AC/2	RT	1	6
AC/2	RT	1	6
Ammo (AC) 45	RT	1	1
AC/2	LT	1	6
AC/2	LT	1	6
Ammo (AC) 45	LT	1	1

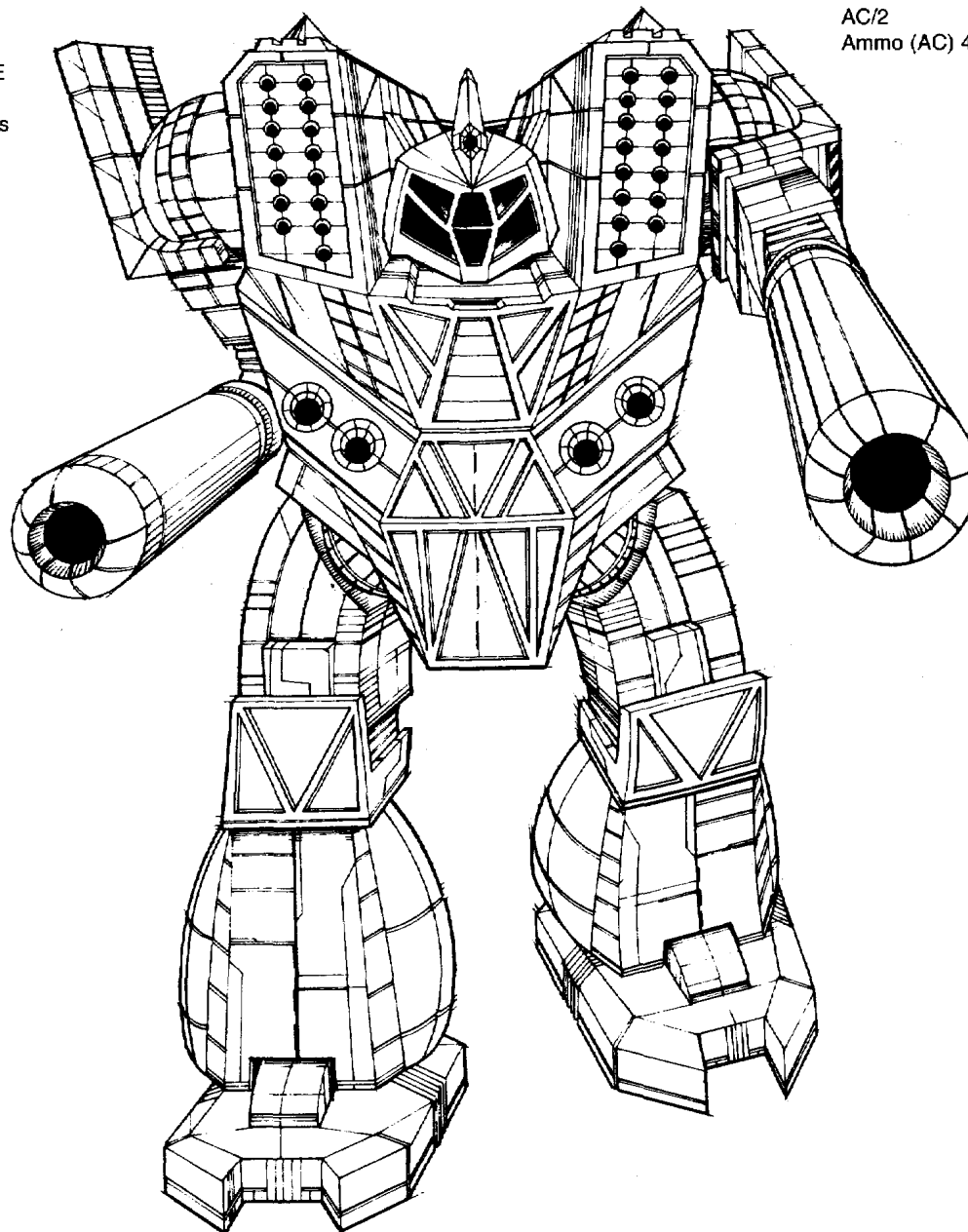



OVERVIEW

Defiance Industries on Hesperus has produced limited numbers of the much-maligned *Banshee* since the time of the Star League. Although several projects enjoy higher priorities than the reconfiguration of the *Banshee*, the Federated Commonwealth's effort to renovate the design has produced the promising BNC-5S model, which features the lightweight Edasich Motors 380 XL engine, double sinks, and a wide range of powerful weapons.

The BNC-5S's torso-mounted Poland Main Model A Gauss rifle, which replaces the original design's Emperor-A autocannon, serves as the *Banshee's* primary weapon, and two extended-range Defiance 1001 PPCs replace the single Magna Hellstar employed in earlier versions of the *Banshee*. Additionally, designers have equipped the BNC-5S with a second small laser, four medium lasers and a TharHes Maxi SRM-6 rack. This new weapons configuration provides the *Banshee* with far more firepower than the design previously possessed, which should enable the 'Mech to forge a new reputation as an effective and formidable fighting machine.

Mass: 95 tons
Chassis: Foundation 210
Power Plant: GM 380 XL
Cruising Speed: 43.2 kph
Maximum Speed: 64.8 kph
Jump Jets: None

Jump Capacity: None
Armor: Longanecker PlastiSteel
Armament:

- 1 Poland Main Model A Gauss Rifle
- 2 Defiance 1001 PPCs
- 1 TharHes Maxi SRM-6 Rack
- 4 Defiance B3M Medium Lasers
- 2 Defiance B3S Small Lasers

Manufacturer: Defiance Industries
Primary Factory: Hesperus
Communications System: Angst Clear Channel 3
Targeting and Tracking System: Angst Clear View 2A

Type: **Banshee**
 Technology Base: Inner Sphere
 Tonnage: 95

Weapons and Ammo	Location	Critical	Tonnage
Gauss Rifle	LT	7	15
Ammo (Gauss) 8	LT	1	1
ER PPC	RT	3	7
ER PPC	RT	3	7
SRM 6	RA	2	3
Ammo (SRM) 15	RA	1	1
Medium Laser	LA	1	1
Medium Laser	LA	1	1
Medium Laser	LT (R)	1	1
Medium Laser	RT (R)	1	1
Small Laser	CT	1	.5
Small Laser	H	1	.5

Equipment		Mass
Internal Structure:		9.5
Engine:	380 XL	20.5
Walking MP:	4	
Running MP:	6	
Jumping MP:	0	
Heat Sinks:	14 [28]	4
Gyro:		4
Cockpit:		3
Armor Factor:	240	15
	<i>Internal Structure</i>	<i>Armor Value</i>
Head	3	9
Center Torso	30	40
Center Torso (rear)		17
R/L Torso	20	30
R/L Torso (rear)		10
R/L Arm	16	21
R/L Leg	20	26

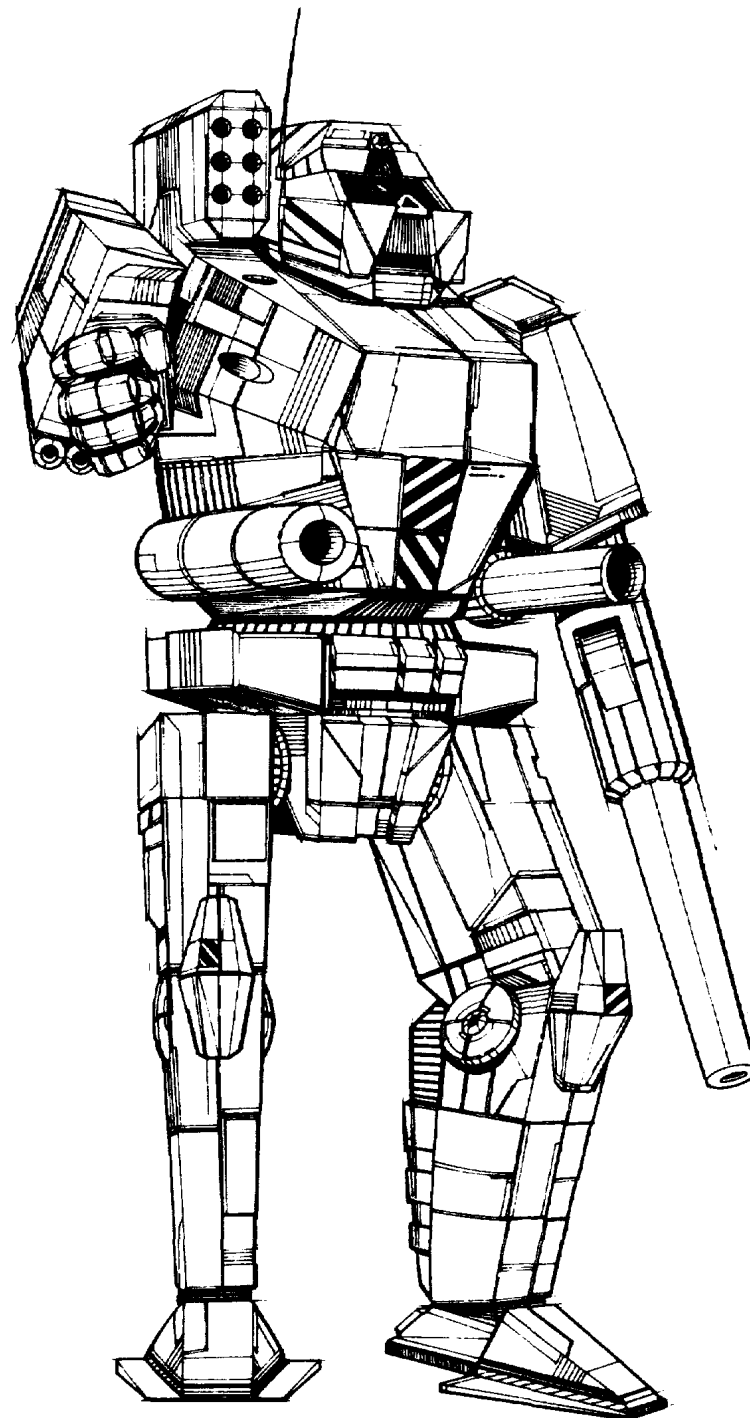



OVERVIEW

Surviving Star League records contain no mention of the *Annihilator*, which first appeared in 3009 in service with Wolf's Dragoons. Some observers contend that the Dragoons maintain a vast warehouse of the BattleMechs, while others claim that the mercenaries possess a secret factory or other source of *Annihilators*. All observers, however, agree that the *Annihilator* is a particularly resilient and easily repaired 'Mech.

Recently, the Dragoons have begun testing a frightening new version of the *Annihilator*, which features Cellular Ammunition-Storage Equipment, four Mydron Excel LB 10-X autocannons in place of the Class 10 model, and four Magna 400P medium pulse lasers in place of the standard medium lasers provided with the design.

Mass: 100 tons
Chassis: Star League MN-01
Power Plant: Nissan 200
Cruising Speed: 22 kph
Maximum Speed: 32 kph
Jump Jets: None
Jump Capacity: None
Armor: Starshield Special-b with CASE
Armament:
 4 Mydrion Excel LB 10-X Autocannons
 4 Magna 400P Medium Pulse Lasers
Manufacturer: Unknown
Primary Factory: Unknown
Communications System: Garret T19-G
Targeting and Tracking System: Wasat Aggressor Type 5

Weapons and Ammo	Location	Critical	Tonnage
LB 10-X AC	RA	6	11
LB 10-X AC	LA	6	11
LB 10-X AC	RT	6	11
LB 10-X AC	LT	6	11
Ammo (LB-X) 20	RT	2	2
CASE	RT	1	.5
Ammo (LB-X) 20	LT	2	2
CASE	LT	1	.5
Medium Pulse Laser	LA	1	2
Medium Pulse Laser	RA	1	2
Medium Pulse Laser	CT	1	2
Medium Pulse Laser	CT	1	2

Type: Annihilator
Technology Base: Inner Sphere
Tonnage: 100

Equipment	Mass	
Internal Structure:	10	
Engine:	200	
Walking MP:	2	
Running MP:	3	
Jumping MP:	0	
Heat Sinks:	17	
Gyro:	2	
Cockpit:	3	
Armor Factor:	200	
	<i>Internal Structure</i>	<i>Armor Value</i>
Head	3	9
Center Torso	31	25
Center Torso (rear)		10
R/L Torso	21	21
R/L Torso (rear)		9
R/L Arm	17	24
R/L Leg	21	24

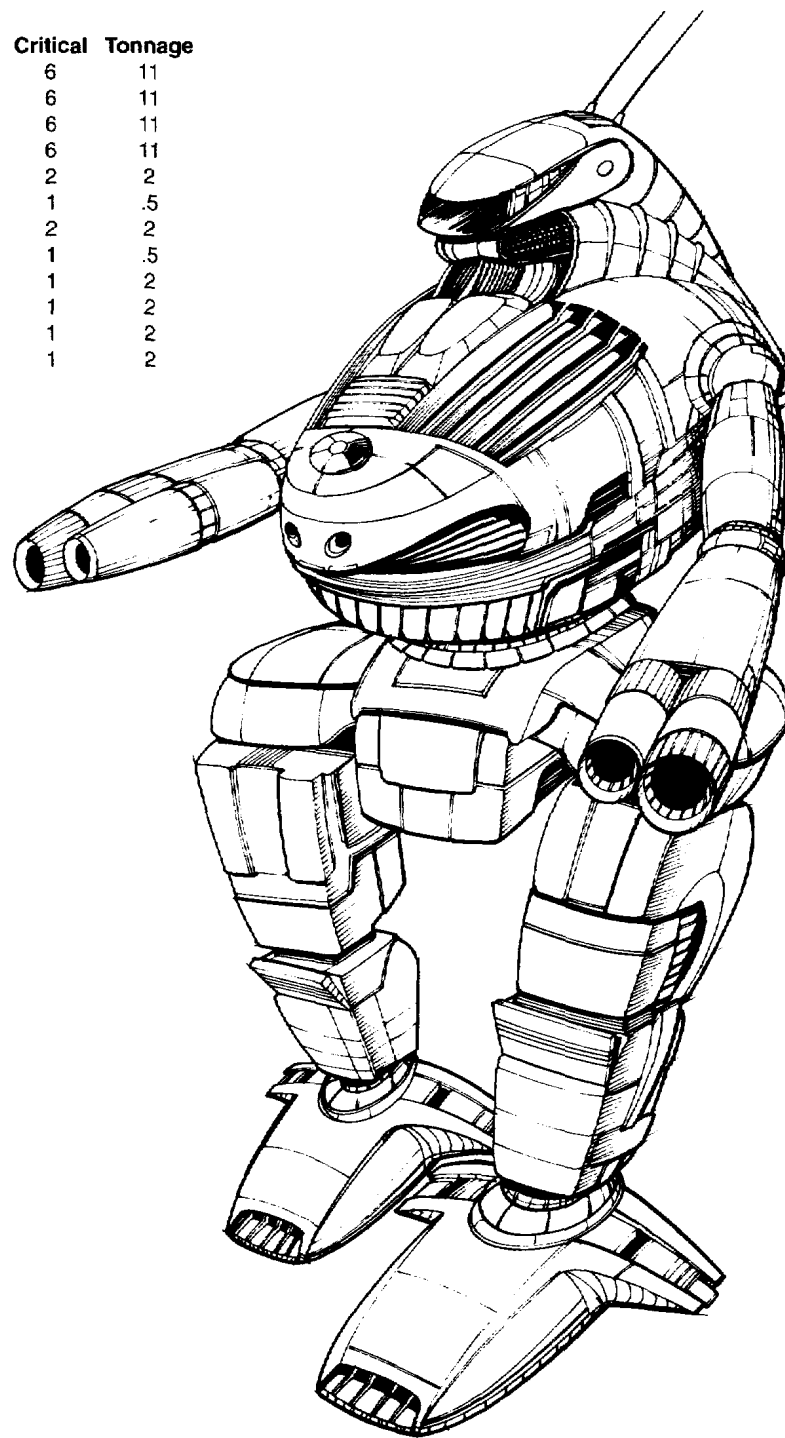



OVERVIEW

The AS7-K *Atlas* is a formidable new design that incorporates an extra-light engine, Cellular Ammunition-Storage Equipment, and an impressive array of weapons that includes a Dragon's Fire Gauss rifle. This massive weapon sits in the 'Mech's right torso, opposite the Shigunga LRM-20 rack. Two Victory Nickel Alloy extended-range large lasers, two Victory Heartbeat medium pulse lasers, and the Yori Flyswatter anti-missile system complete the design's arsenal.

The Federated Commonwealth, frantically trying to expand the *Atlas* assembly line at Defiance Industries on Hesperus, is beginning to produce a model much more like the original *Atlas*. The most significant feature of this design, the AS7-S, is its use of double heat sinks, which increase the design's ability to dissipate heat. The AS7-S lacks an extra-light engine, but its weapons configuration includes two rear-firing Coventry T4H Streak SRM racks.

Mass: 100 tons
Chassis: Foundation Type 10X
Power Plant: Vlar 300 XL
Cruising Speed: 32.4 kph
Maximum Speed: 54 kph
Jump Jets: None
Jump Capacity: None
Armor: Durallex Special Heavy with CASE

Armament:
 1 Dragon's Fire Gauss Rifle
 1 Shigunga LRM-20 Rack
 2 Victory Nickel Alloy Extended Range Large Lasers
 2 Victory Heartbeat Medium Pulse Lasers
 1 Yori Flyswatter Anti-Missile System
Manufacturer: Yori Mech Works, Independence Weaponry
Primary Factory: Al Na'ir (Yori), Quentin
 (Independence)

Communications System: Sipher Security Plus
Targeting and Tracking System: Matabushi Sentinel

Type: Atlas
Technology Base: Inner Sphere
Tonnage: 100

Equipment		Mass
Internal Structure:		10
Engine:	300 XL	9.5
Walking MP:	3	
Running MP:	5	
Jumping MP:	0	
Heat Sinks:	20	10
Gyro:		3
Cockpit:		3
Armor Factor:	304	19

	Internal Structure	Armor Value
Head	3	9
Center Torso	31	47
Center Torso (rear)		14
R/L Torso	21	32
R/L Torso (rear)		10
R/L Arm	17	34
R/L Leg	21	41

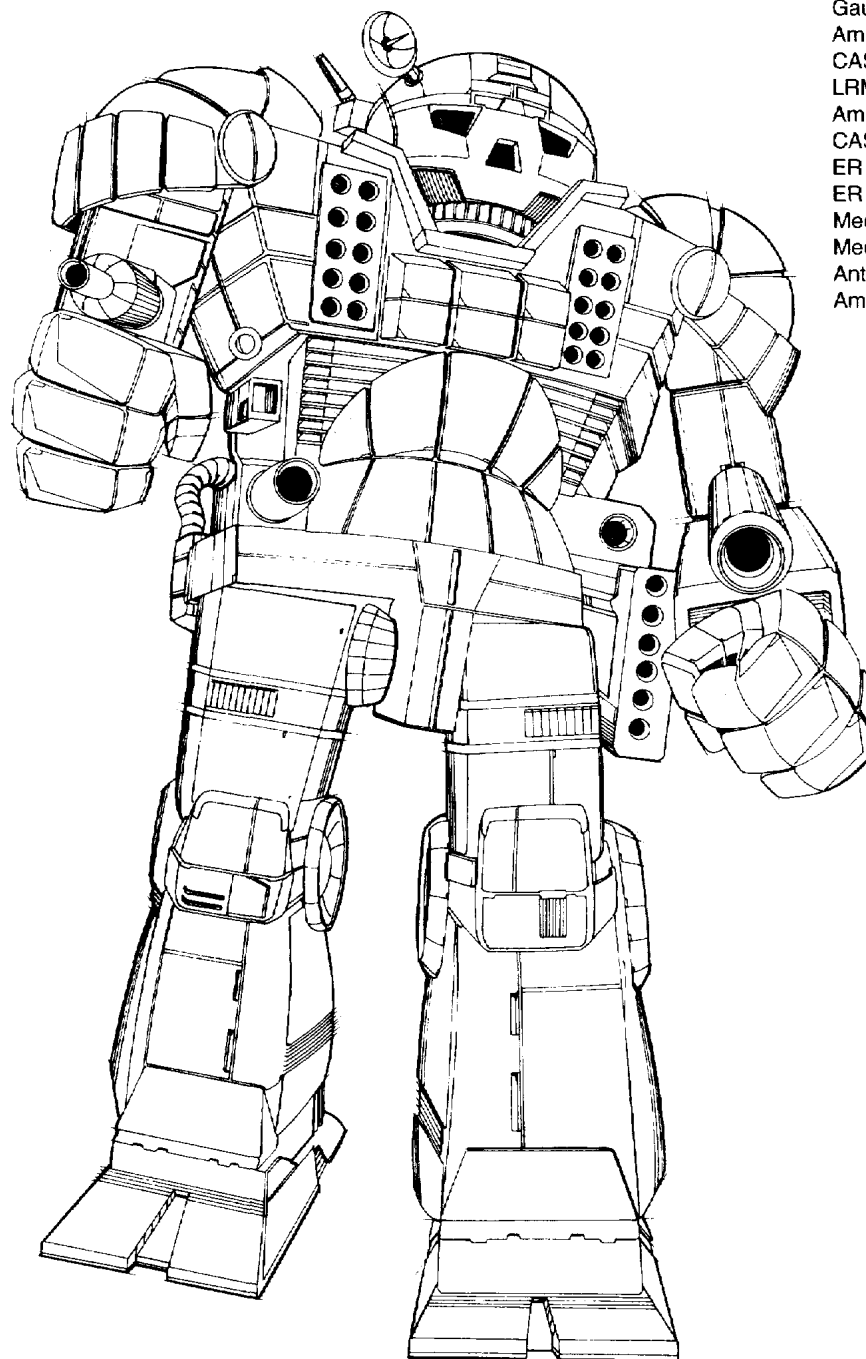

Weapons and Ammo	Location	Critical	Tonnage
Gauss Rifle	RT	7	15
Ammo (Gauss) 16	RA	2	2
CASE	RT	1	.5
LRM 20	LT	5	10
Ammo (LRM) 12	LT	2	2
CASE	LT	1	.5
ER Large Laser	LA	2	5
ER Large Laser	RA	2	5
Medium Pulse Laser	CT (R)	1	2
Medium Pulse Laser	CT (R)	1	2
Anti-Missile System	LA	1	.5
Ammo (Anti-Missile) 12	LT	1	1



OVERVIEW

The *Imp* is clearly a product of Wolf's Dragoons manufacture. This was strongly suspected when large numbers of *Imps* appeared among Dragoon forces after the mercenaries had sustained heavy losses. Later, the Dragoons origin of the *Imp* was confirmed by Precentor III-epsilon Gordon Gaumnitz, an undercover MechWarrior-agent operating as a captain in the mercenary Eridani Light Horse. During a conference with Wolf's Dragoons on Outreach, Gaumnitz spoke with Dragoon MechWarriors who were ecstatic about their test rides in a new 'Mech design. Precentor Gaumnitz quickly realized that the MechWarriors were describing a previously unidentified 'Mech and he persuaded the warriors to describe the Vlar 300 XL-powered machine.

The *Imp* reportedly carries two Magna Firestar extended-range particle projection cannons, two Magna 400P medium pulse lasers, two Martell Model 5 medium lasers, a single Thunderbolt-12 large pulse laser, and a single Mitchell Systems LRM-15. The design's 30 heat sinks help the *Imp* deal with the tremendous amounts of heat generated by its fearsome array of weapons.

Mass: 100 tons
Chassis: Star League IM-03x
Power Plant: Vlar 300 XL
Cruising Speed: 32 kph
Maximum Speed: 54 kph
Jump Jets: None
Jump Capacity: None
Armor: Maximillian 300
Armament:
 2 Magna Firestar Extended Range PPC
 1 Mitchell Systems LRM-15
 1 Thunderbolt-12 Large Pulse Laser
 2 Magna 400P Medium Pulse Lasers
 2 Martell Model 5 Medium Lasers
Manufacturer: Unknown
Primary Factory: Unknown
Communications System: Pauley-Bronson Z
Targeting and Tracking System: Wasat Aggressor Type 8

Type: Imp
Technology Base: Inner Sphere
Tonnage: 100

Equipment		Mass
Internal Structure:		10
Engine:	300 XL	9.5
Walking MP:	3	
Running MP:	5	
Jumping MP:	0	
Heat Sinks:	30	20
Gyro:		3
Cockpit:		3
Armor Factor:	288	18
	<i>Internal Structure</i>	<i>Armor Value</i>
Head	3	9
Center Torso	31	40
Center Torso (rear)		21
R/L Torso	21	30
R/L Torso (rear)		12
R/L Arm	17	25
R/L Leg	21	42

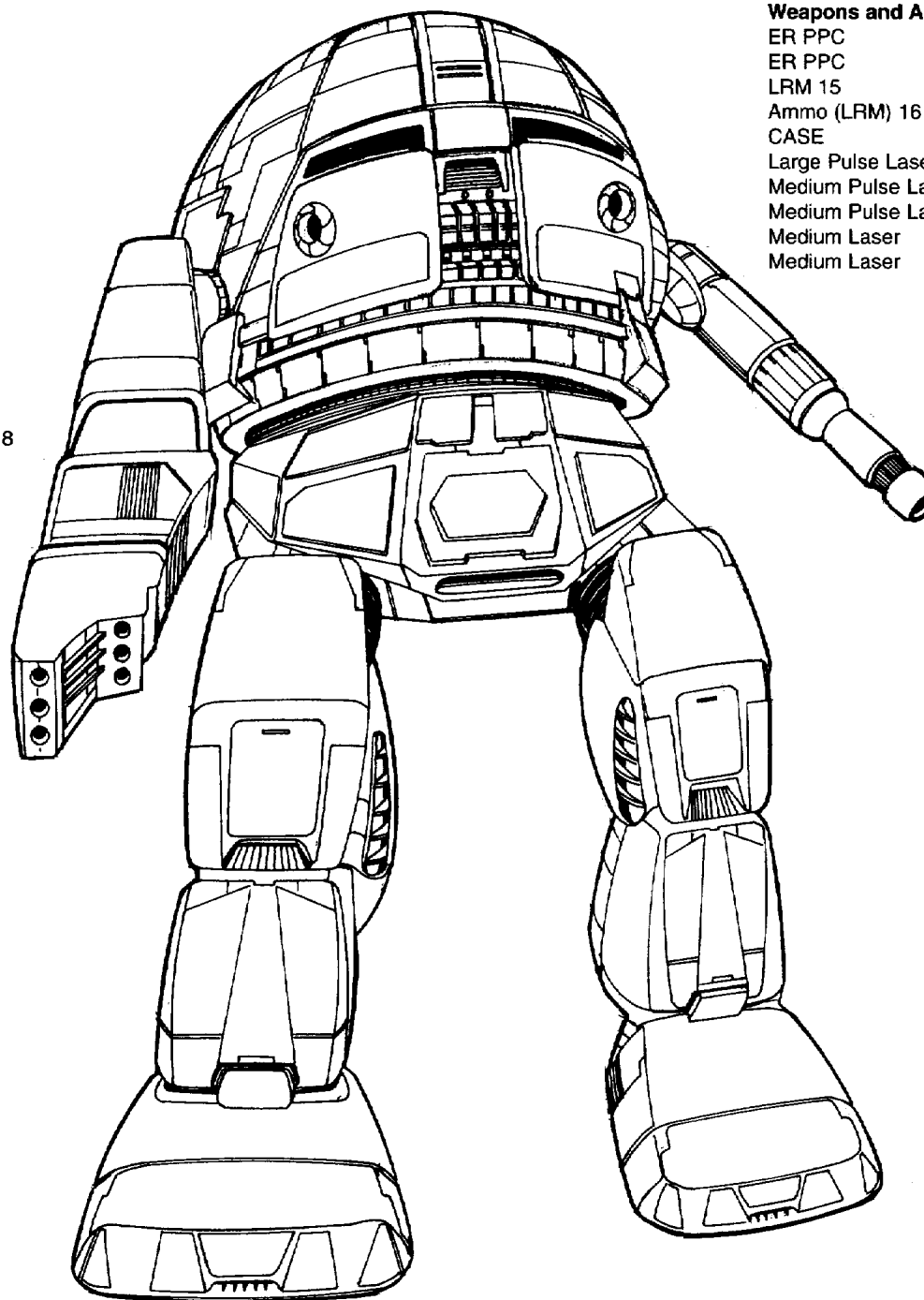

Weapons and Ammo	Location	Critical	Tonnage
ER PPC	RT	3	7
ER PPC	LT	3	7
LRM 15	RA	3	7
Ammo (LRM) 16	LT	2	2
CASE	LT	1	.5
Large Pulse Laser	LA	2	7
Medium Pulse Laser	CT	1	2
Medium Pulse Laser	CT	1	2
Medium Laser	RT	1	1
Medium Laser	RT	1	1



OVERVIEW

Weighing 100 tons, the *King Crab* was the largest 'Mech ever designed at its introduction in 2741. Less versatile than the later-built 100-ton *Atlas*, the *King Crab* is ideally suited to close fighting, with armor nearly as heavy as a light 'Mech and enough firepower to destroy a medium 'Mech in one salvo. Built for sheer firepower rather than speed, with state-of-the-art electronics, armor and communications gear, this 'Mech is a power to be reckoned with.

The *King Crab* carries sixteen tons of ferro-fibrous armor with no weak points. Its primary weapons are the twin Deathgiver autocannon/20s located in its huge arms. Its secondary weapons systems are the Simpson-15 long-range missile launcher in the left torso and a huge Exostar large laser in the right.

Opponents of other slow but lethally equipped 'Mechs usually try to keep their distance while attempting to pick away at the 'Mech's armor, but the *King Crab*'s long-range missile system makes that tactic risky at best. When the missiles run out, the 'Mech can still blast away with its huge Exostar laser. The only proven way to destroy the *King Crab* is to outnumber it with heavy or assault 'Mechs. The *King Crab* will still take several enemy 'Mechs with it before it goes down, however.

The 'Mech's only obvious weakness—a small one—is the location of its autocannons. Though well-armored by any standards, the *King Crab*'s arms are the appendages most susceptible to damage. One internal hit to either arm will usually silence the cannons. If both cannons are lost or run out of ammunition, the *King Crab* will usually retire from the field. Without constant resupply, the 'Mech is little more than a slowly moving target. Once the *King Crab*'s shelling stops, enemy 'Mechs often try to pounce on it before it can withdraw from battle.

KGC-000 KING CRAB

Mass: 100 tons
Chassis: Hollis Mark II
Power Plant: Vlar 300
Cruising Speed: 32 kph
Maximum Speed: 54 kph
Jump Jets: None
Jump Capacity: None
Armor: Aldis X Ferro-Fibrous with CASE
Armament:
 2 Deathgiver Autocannon/20s
 1 Simpson LRM-15 Missile Rack
 1 Exostar Large Laser
Manufacturer: Cosara Weaponries
Communications System: Dalban Commline
Targeting and Tracking System: Dalban HiRez-B

Type: **King Crab**
 Technology Base: Inner Sphere
 Tonnage: 100

Equipment		Mass
Internal Structure:		10
Engine:	300	19
Walking MP:	3	
Running MP:	5	
Jumping MP:	0	
Heat Sinks:	15	5
Gyro:		3
Cockpit:		3
Armor Factor:	287	16
	<i>Internal Structure</i>	<i>Armor Value</i>
Head	3	9
Center Torso	31	40
Center Torso (rear)		16
R/L Torso	21	30
R/L Torso (rear)		12
R/L Arm	17	34
R/L Leg	21	35

Weapons and Ammo	Location	Critical	Tonnage
AC/20	LT/LA	10	14
Ammo (AC) 5	LT	1	1
CASE	LT	1	.5
AC/20	RT/RA	10	14
Ammo (AC) 5	RT	1	1
CASE	RT	1	.5
LRM 15	LT	3	7
Ammo (LRM) 8	LT	1	1
Large Laser	RT	2	5

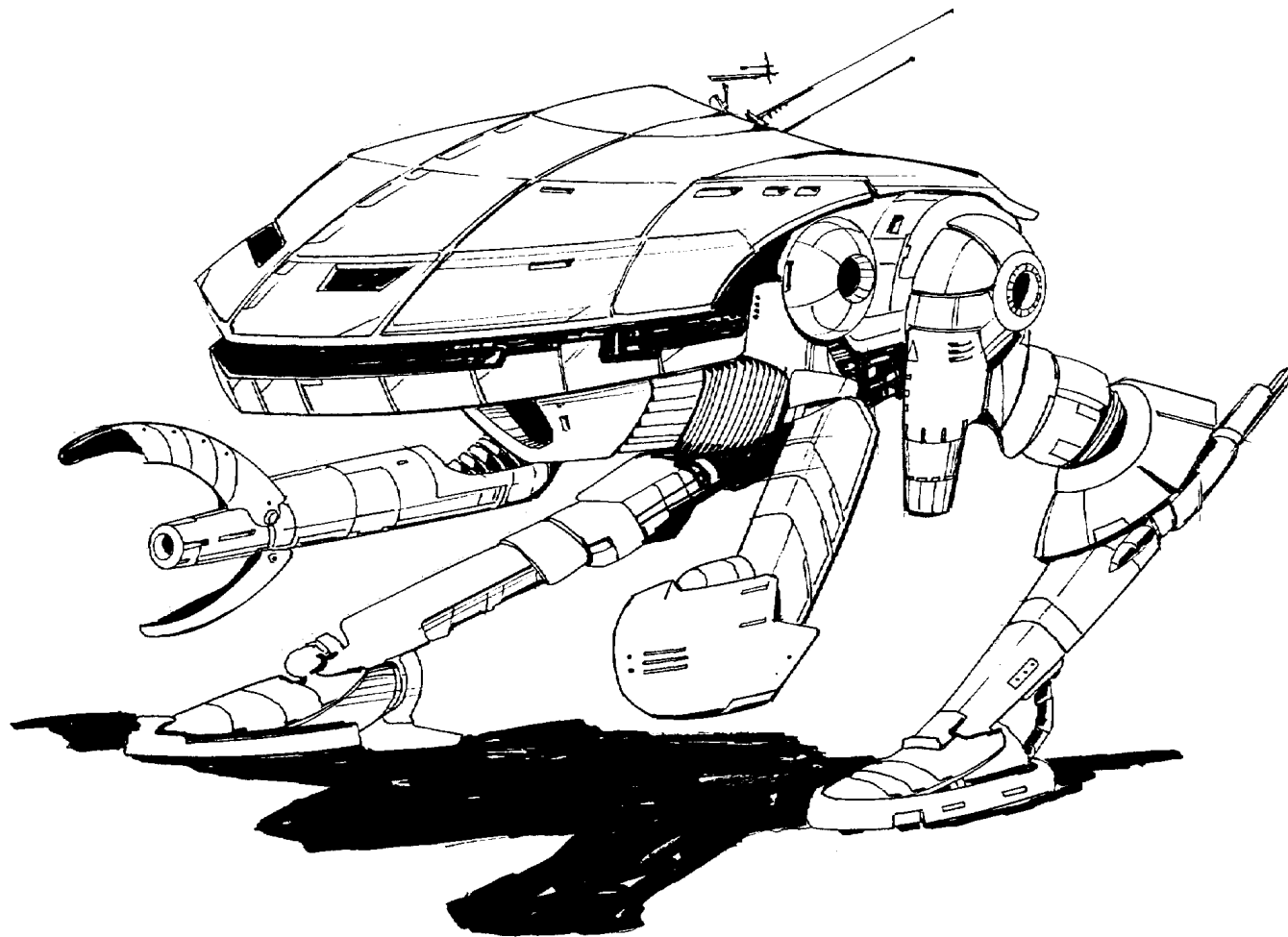

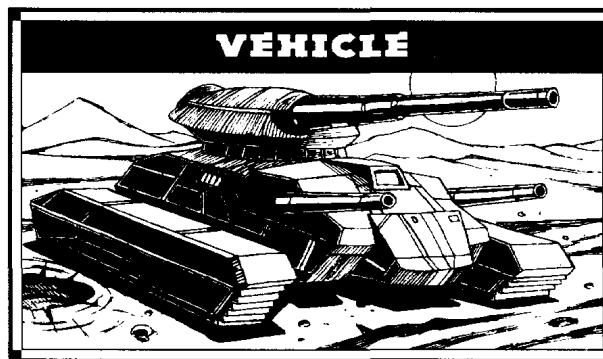

OVERVIEW

A radical departure from standard design of its day, the fusion-powered Gabriel is easily the fastest ground vehicle available. With a lightning speed of up to 243 kph and a weight of only 5 tons, its maneuverability made it the ideal scout when it was developed for the Star League Defense Forces in 2712.

Though designed for reconnaissance rather than combat, the Gabriel carries a Maxell TR medium laser. Mounted in the turret, the weapon offers a 360-degree arc of fire. The automatic target-acquisition system swivels the turret toward the closest threat, leaving it up to the pilot to aim and then fire. If necessary, the pilot can override the system, but the logic algorithms have proven remarkably successful.

The Gabriel carries only one ton of lightweight ferro-aluminum armor, not enough to stop even one medium laser hit on the side. Its front, back, and turret have somewhat better protection. Normally reserved for aerospace fighters, ferro-aluminum armor consists of a porous "foamed" alloy that is hard but brittle compared to standard armor plate.

The Gabriel's main purpose is to gather intelligence, usually carrying information back to the parent unit. It is equipped with the CBR CommStat system, advanced communications and sensor equipment for longer-range transmissions. The communications pack scrambles the message and bounces it off the nearest satellite. Sending and receiving messages quickly and accurately is made even easier by the vehicle's automatic satellite-tracking gear. The vehicle must, however, slow to 100 kph to send or receive messages.

Once Gabriel pilots discovered that they could angle the vehicle's forward fans at a degree that made the pitch-back noise sound like a wailing trumpet, this practice became a favorite method of announcing a pilot's return to the garrison. This somewhat risky maneuver makes for an extremely rough ride and is highly discouraged, though to little avail.

Mass: 5 tons
Movement Type: Hover
Power Plant: VOX 35
Cruising Speed: 162 kph
Flank Speed: 243 kph
Armor: Bowie Ferro-Fibrous
Armament:
 1 Maxell TR Medium Laser
Manufacturer: Bowie Industries
Communications System: CBR CommStat
Targeting and Tracking System: Halo 901

Type: Gabriel
 Technology Base: Inner Sphere
 Movement Type: Hover
 Tonnage: 5

Equipment		Mass
Internal Structure:		.5
Engine:	35	1.5
Type:	Fusion	
Cruising MP:	15	
Flank MP:	23	
Heat Sinks:	10	0
Control Equipment:		.25
Lift Equipment:		.5
Power Amplifier:		0
Turret:		.1
Armor Factor:	18	1
	<i>Armor Value</i>	
Front	5	
R/L Side	3/3	
Rear	3	
Turret	4	

Weapons and Ammo	Location	Tonnage
Medium Laser	Turret	1

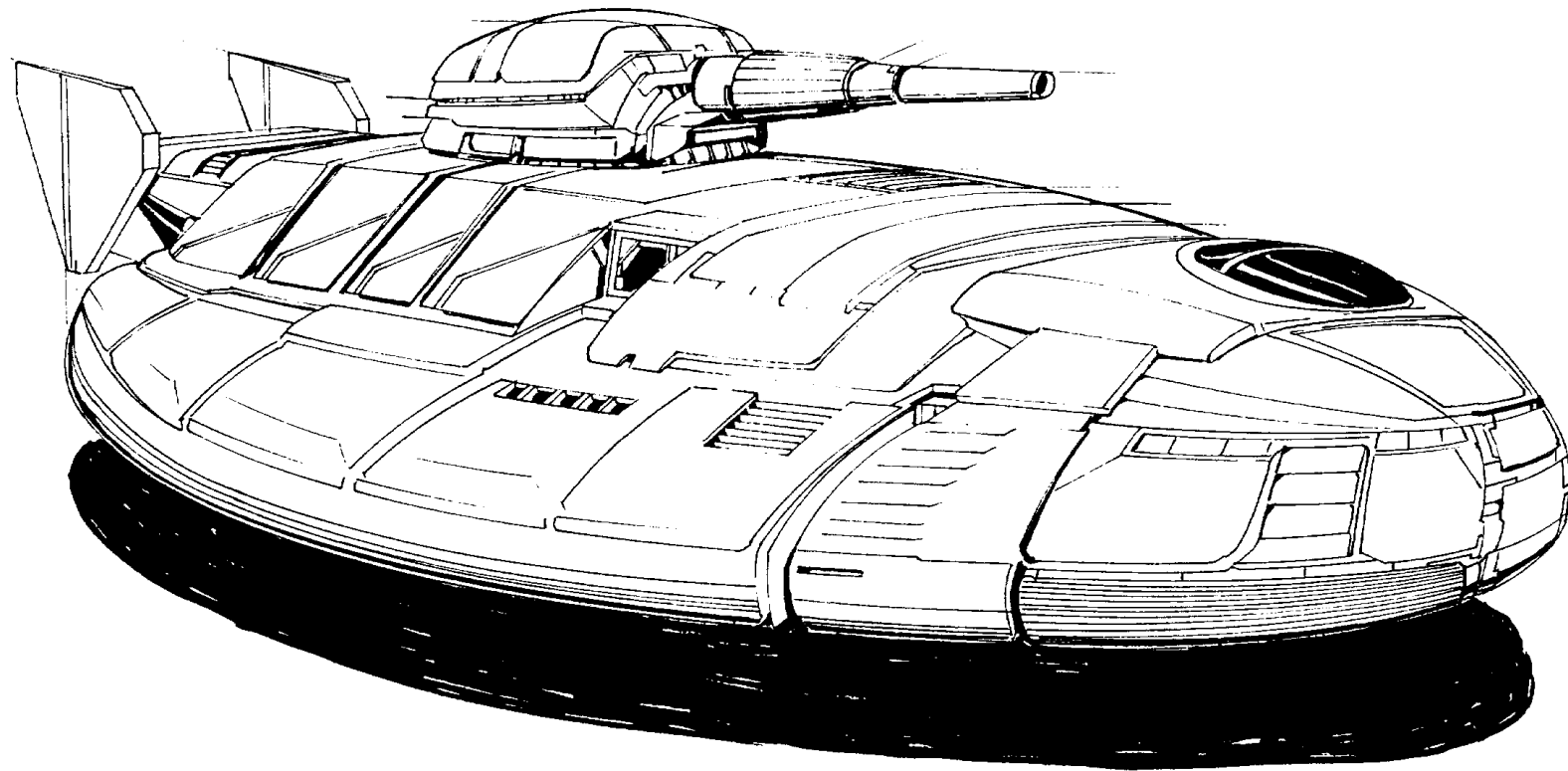

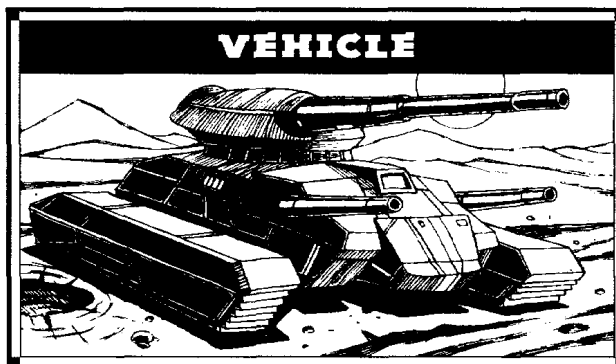

OVERVIEW

The Ripper was designed in 2680 to carry elite infantry units and drop them into battle. Though heavily armored for a VTOL, the Ripper cannot survive even two shots from a small laser. The 10-ton craft is so fast and maneuverable at 194 kph, however, that hitting it poses quite a challenge. The craft is so fast that the infantry compartment has special acceleration couches so that passengers can handle the high Gs. The VTOL's Omni 70 power plant gives it fusion power, while special ferro-fibrous armor protects it to a certain extent.

Equipped with only two medium lasers, the Ripper is short on firepower. Its mission is not to fight, but rather to get the infantry and their equipment into battle as quickly as possible and then retreat.

As the Ripper begins its descent, the pilot keeps his vehicle's speed high for as long as possible while firing its Omicron 950 twin medium lasers around the fringes of the landing zone. He then pitches the rotor forward and slams the throttle full open. This air-brake tactic reduces the time that the aircraft is exposed to enemy fire, but loose components in the craft are often sent flying. Once the Ripper is on the ground, the pilot cuts the rotors for a mere ten seconds while the engineer, who rides in the infantry compartment, hustles the infantry and their equipment out the door. The engineer then straps himself back in as the craft prepares to take off just seconds later.

The pilot spills any remaining equipment through the open bay by angling the craft to the left during takeoff. Once airborne, he fires the lasers to discourage pursuit as the Ripper quickly gains altitude.

Mass: 10 tons
Movement Type: VTOL
Power Plant: Omni 70
Cruising Speed: 130 kph
Flank Speed: 194 kph
Armor: Aldis Heavy Ferro-Fibrous
Armament:
 2 Omicron 950 Medium Lasers
Manufacturer: Aldis Industries
Communications System: Datacom 100
Targeting and Tracking System: Tarmac Quasar V

Type: Ripper
 Technology Base: Inner Sphere
 Movement Type: VTOL
 Tonnage: 10

Equipment		Mass
Internal Structure:		1
Engine:	70	3
Type:	Fusion	
Cruising MP:	12	
Flank MP:	18	
Heat Sinks:	10	0
Control Equipment:		.5
Lift Equipment:		1
Power Amplifier:		0
Armor Factor:	27	1.5
	<i>Armor Value</i>	
Front	10	
R/L Side	5/5	
Rear	5	
Rotor	2	

Weapons and Ammo	Location	Tonnage
Medium Laser	Front	1
Medium Laser	Front	1
Infantry	Body	1

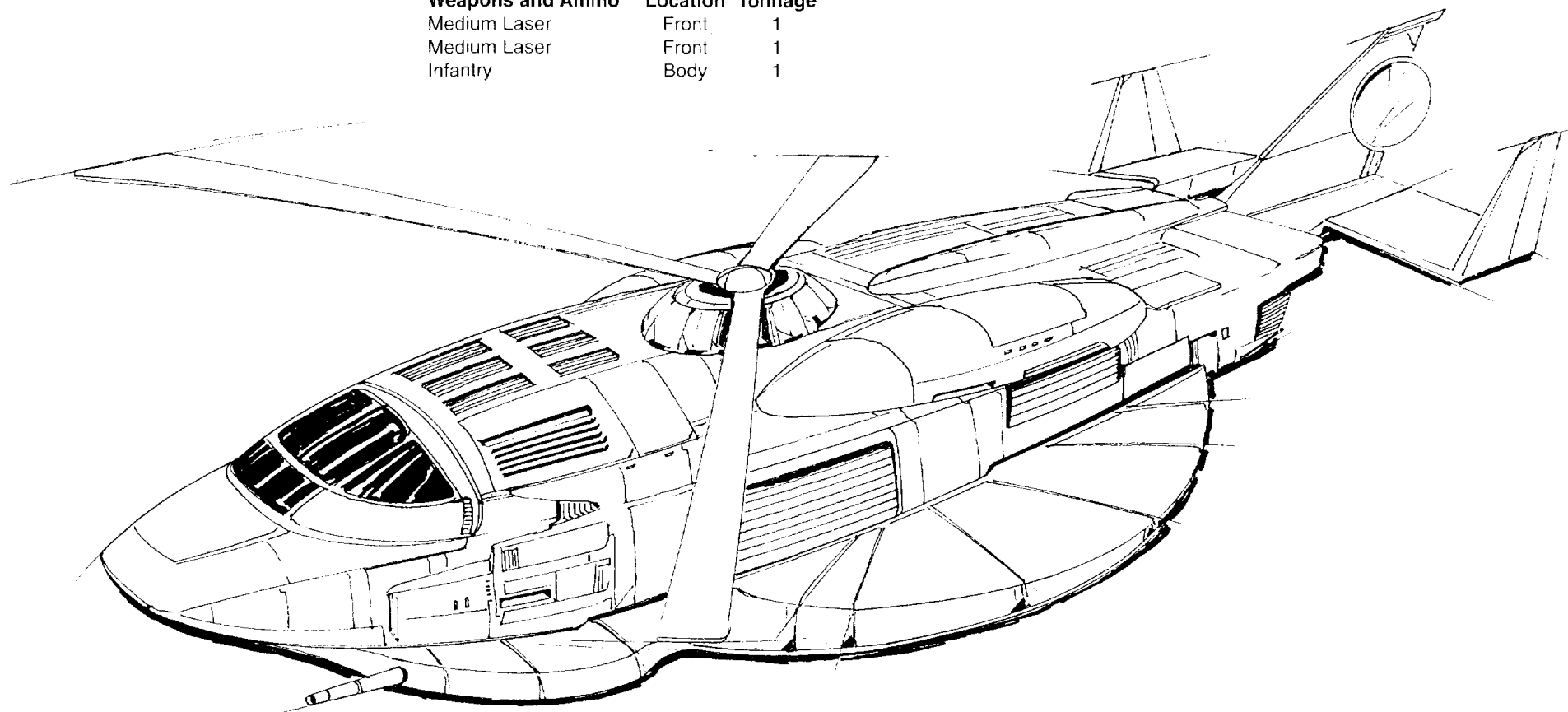

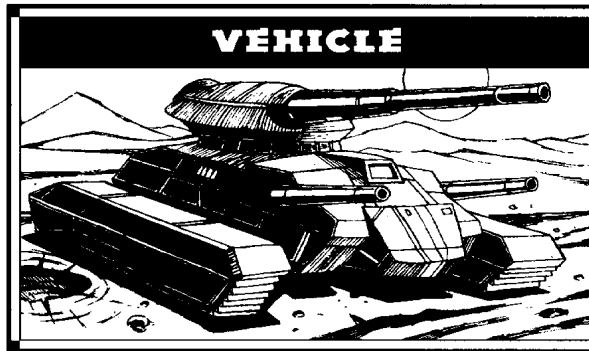

OVERVIEW

The development of the Beagle active probe gave BattleMechs an even greater advantage over vehicles and infantry. Not only were the other branches overmatched by the 'Mech, now they could not even hide, thanks to this sophisticated sensor system. The Beagle tank's main function was to carry the Beagle probe into combat to acquire better and more accurate information on the enemy location and composition. In 2666, the Star League Quartermaster Command authorized a contract with Numall Armored Vehicles for construction of the Beagle Hover-Scout.

The vehicle was designed and ready for distribution within twelve months, and the Star League immediately deployed the Beagle throughout most armor units. Soon after the initial shipments, however, crews discovered a malfunction in the turret ring. Sending the turret into a quick reverse caused the mechanism to lock, effectively freezing the medium laser and sensor wand. Field repairs proved impossible, but because factory repairs often took as long as the original construction, many tank units "forgot" to return their Beagles for adjustments. Though at one time nearly every SLDF tank unit included a Beagle, more than half were the original version and therefore subject to turret jams. The vehicle disappeared during the First Succession War, more from mechanical difficulties than battlefield casualties.

Once the malfunction in the turret was corrected, the Beagle became an effective military vehicle. Never intended for heavy combat, its weapons were designed to keep opponents at a distance and provide the crew with an opportunity to escape. Though the Beagle carries three and one-half tons of ferro-fibrous plating, the armor provides only partial protection. The Beagle relies on its speed to make it an elusive target and to make good its escape after completing its task.

A directional wand housed in the turret carries the sensors for the active probe. The Beagle mounts the highly accurate Aberdovey Mark II medium laser, linked directly to the active probe, and an Exostar-2C small laser for dealing with infantry.

BEAGLE TANK

Mass: 15 tons
Movement Type: Hover
Power Plant: Nissan 95
Cruising Speed: 130 kph
Flank Speed: 194 kph
Armor: Yelm 2.5 Ferro-Fibrous
Armament:
 - 1 Aberdovey Mark II Medium Laser
 - 1 Exostar-2C Small Laser
Manufacturer: Numall Armored Vehicles
Communications System: Essex 88
Targeting and Tracking System: Beagle Active Probe

Type: **Beagle**
 Technology Base: Inner Sphere
 Movement Type: Hover
 Tonnage: 15

Equipment		Mass
Internal Structure:		1.5
Engine:	95	4.5
Type:	Fusion	
Cruising MP:	12	
Flank MP:	18	
Heat Sinks:	10	0
Control Equipment:		.75
Lift Equipment:		1.5
Power Amplifier:		0
Turret:		.25
Armor Factor:	63	3.5
	<i>Armor Value</i>	
Front	15	
R/L Side	12/12	
Rear	10	
Turret	14	

Weapons and Ammo	Location	Tonnage
Beagle Active Probe	Turret	1.5
Medium Laser	Turret	1
Small Laser	Front	.5

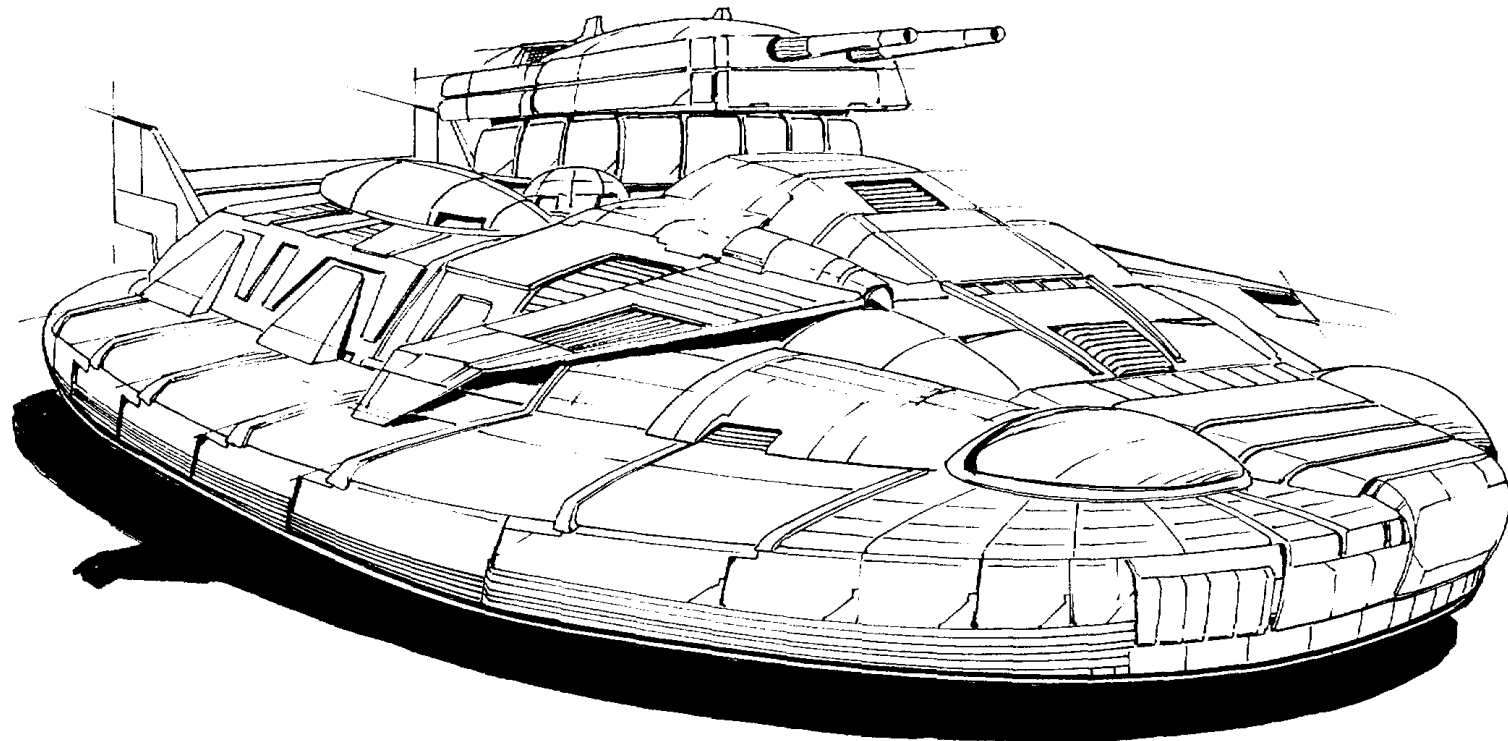

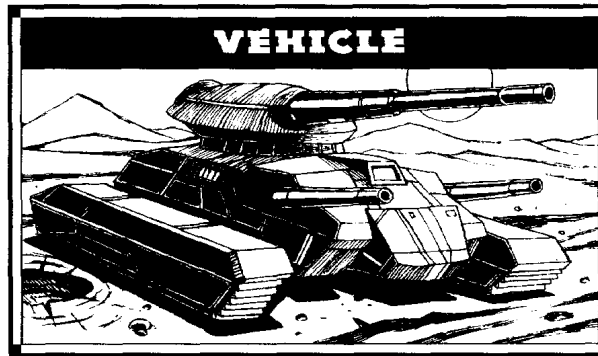

OVERVIEW

The 20-ton Rotunda was designed to be a self-sufficient fighting vehicle and home for its one-person crew. Its LTV 160 fusion power plant gives it the unlimited range needed for scouting and recon duty, and the craft can operate for extended periods of time with little maintenance or other support. These sturdy vehicles move quickly, at speeds up to 146 kph. They usually operate in large numbers behind enemy lines, monitoring enemy communications and troop movements while creating havoc with their impressive firepower. When it comes to raiding and reconnaissance vehicles, the Rotunda is in a class by itself.

Maximizing the driver's comfort, the single-man craft has ample storage for several weeks' worth of food and water, as well as all necessary survival tools and equipment, including a portable stove, tent and survival gear. The craft contains room for a passenger, but the extra space is usually filled with additional gear and the driver's personal effects.

The Rotunda often shows up on identification profiles as a civilian ICE transport rather than an armored scout car. Its Mercury Weave ferro-fibrous armor offers respectable protection to the driver along with the control and cockpit components. The placement of those components, however, prevents quick entry and escape from the cockpit.

The Rotunda's weapons array includes a Holly SRM-2 launcher, one of the best-known and most reliable missile systems ever created, and an Amdecker 300 large laser. Though respected for its accuracy, the Amdecker sometimes generates large amounts of heat, causing monitoring and ventilation difficulties. This heat buildup can damage the weapon and its mounting, requiring constant maintenance.

Mass: 20 tons
Movement Type: Wheeled
Power Plant: LTV 160
Cruising Speed: 97 kph
Flank Speed: 146 kph
Armor: Mercury Weave Ferro-Fibrous
Armament:
 1 Holly SRM-2 Missile Rack
 1 Amdecker 300 Large Laser
Manufacturer: Buhallin Military Products
Communications System: SP/2 HAYOT
Targeting and Tracking System: Hanover Sight 3000-A-K-P

Type: **Rotunda**
 Technology Base: Inner Sphere
 Movement Type: *Wheeled*
 Tonnage: 20

Equipment		Mass
Internal Structure:		2
Engine:	160	9
Type:	Fusion	
Cruising MP:	9	
Flank MP:	14	
Heat Sinks:	10	0
Control Equipment:		1
Lift Equipment:		0
Power Amplifier:		0
Turret:		0
Armor Factor:	18	1
	<i>Armor</i>	
	<i>Value</i>	
Front	6	
R/L Side	4/4	
Rear	4	

Weapons and Ammo	Location	Tonnage
Large Laser	Front	5
SRM 2	Front	1
Ammo (SRM) 50	Body	1

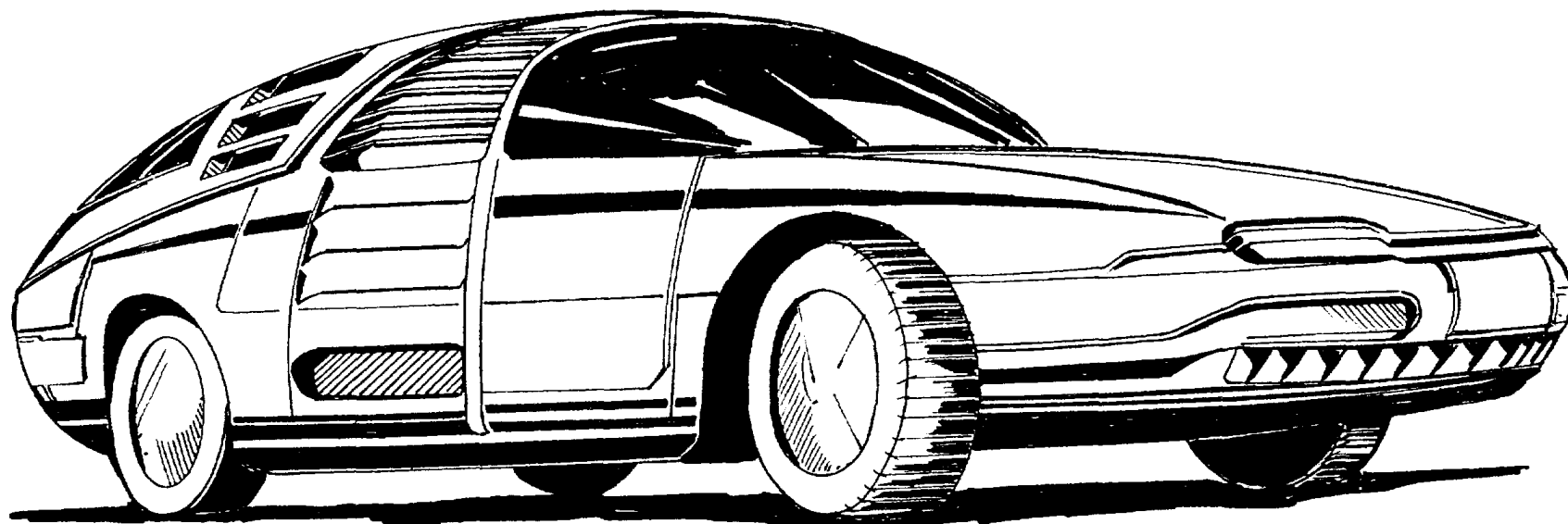

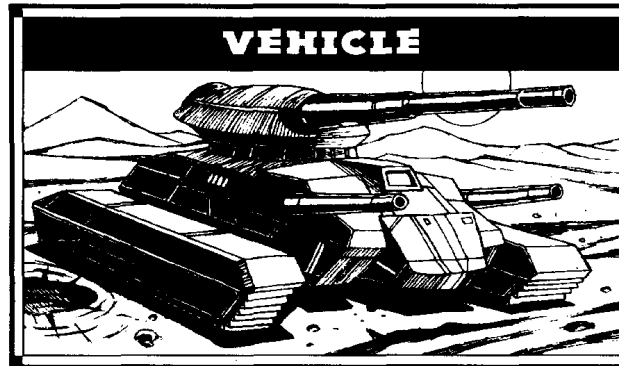

OVERVIEW

Though it is classified as a combat scout VTOL craft, the 25-ton Nightshade was designed in 2597 specifically to carry the Guardian ECM Suite into combat.

The Guardian emits a broad-band signal that interferes with all sonar, radar, UV, IR, and magscan sensors, thus protecting all units in a radius of up to 180 meters by projecting a "cloak" to its enemies. Enemy long-range sensors can find vehicles and 'Mechs within the curtain, but the Guardian obscures the reading and prevents identification. By the time the enemy enters visual range, sensors can sometimes override the jamming, but by this time most pilots rely on their own eyes to track the opposition.

As a combat chopper, the Nightshade is at best mediocre. The massive Vlar 205 engine gives it excellent acceleration, up to 194 kph, but at the cost of extra cargo space. Its only weapon is a Randall medium laser mounted on the nose of the craft. Hooked to the pilot's helmet, the gun swivels with him. The system works well, but needs supporting weapons to protect the chopper more fully.

The Nightshade carries only two tons of standard armor plating, and so is vulnerable even to light ground fire. As with any VTOL, the pilot's main concern is the vulnerable rotor assembly, which cannot be effectively armored for aerodynamic reasons.

Mass: 25 tons
Movement Type: VTOL
Power Plant: GM 210
Cruising Speed: 151 kph
Flank Speed: 228 kph
Armor: FiberTech Light
Armament:
 1 Randall Medium Laser
Manufacturer: Yelm Weapons
Communications System: Johnston VRR
Targeting and Tracking System: NIRAD 210

Type: **Nightshade**
 Technology Base: Inner Sphere
 Movement Type: VTOL
 Tonnage: 25

Equipment		Mass
Internal Structure:		2.5
Engine:	210	13.5
Type:	Fusion	
Cruising MP:	14	
Flank MP:	21	
Heat Sinks:	10	0
Control Equipment:		1.5
Lift Equipment:		2.5
Power Amplifier:		0
Armor Factor:	32	2
	<i>Armor Value</i>	
Front	10	
R/L Side	6/6	
Rear	8	
Rotor	2	

Weapons and Ammo	Location	Tonnage
Guardian ECM Suite	Body	1.5
Medium Laser	Front	1
Cargo	Body	.5

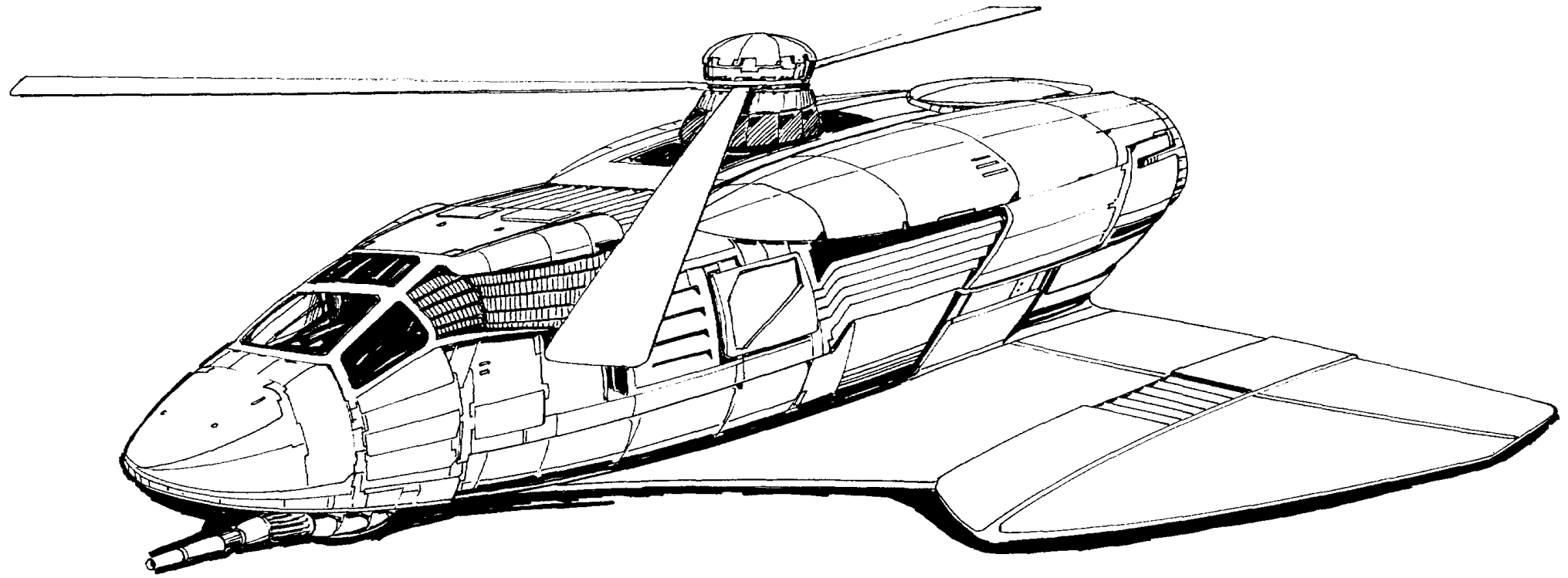

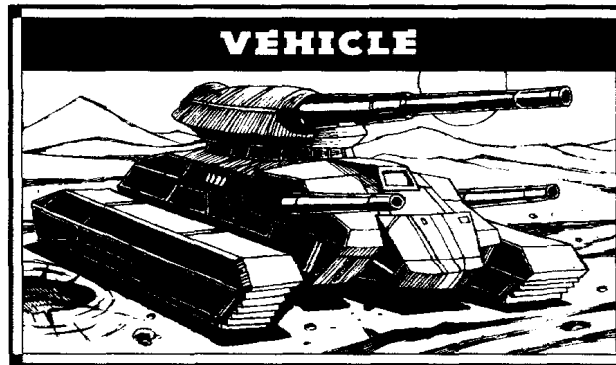

OVERVIEW

Developed in 2622 to provide inexpensive support for ground troops, the Cyrano proved to be an able attack fighter. The heaviest VTOL in the Star League Defense Force, it became the Star League Army's standard gunship, and often escorted Ripper and Nightshade VTOLs on dangerous missions.

The Cyrano earned its name because of its dominant physical feature, the forward-mounted Fuersturm-C large laser. The system weighs almost five tons and takes up the bulk of the VTOL's forward section. Like the literary character from whom the VTOL's name is taken, this feature gives the craft a distinctive profile. Though the 30-ton craft has a more than adequate flank speed of 194 kph, the Cyrano's unusual handling characteristics make numerous training missions essential to teach the pilots how to compensate for the weight imbalances caused by the vehicle's protruding nose.

The pilot uses an early version of the neurohelmet to fire at his target. The Beagle active probe allows the Cyrano to locate enemy infantry, armor, and 'Mechs. Impulses from the Beagle are displayed in front of the pilot, who simply looks at a target and fires. The Sky Tracer target-acquisition computer makes automatic adjustments, while the Beagle provides instant analysis of the target, including damage, weapon status and probable response. The two systems work well together, giving the Cyrano excellent fighting capability.

Like all VTOLs, the Cyrano is vulnerable to enemy fire because aerodynamics and weight problems make it almost impossible to include adequate armor.

Mass: 30 tons
Movement Type: VTOL
Power Plant: DAV 220
Cruising Speed: 130 kph
Flank Speed: 194 kph
Armor: Paulina DL Ferro-Fibrous
Armament:
 1 Fuersturm-C Large Laser
Manufacturer: Paulina Weapons
Communications System: Garret M250
Targeting and Tracking System: Sky Tracer WL

Type: **Cyrano**
 Technology Base: Inner Sphere
 Movement Type: VTOL
 Tonnage: 30

Equipment		Mass
Internal Structure:		3
Engine:	220	15
Type:	Fusion	
Cruising MP:	12	
Flank MP:	18	
Heat Sinks:	10	0
Control Equipment:		1.5
Lift Equipment:		3
Power Amplifier:		0
Armor Factor:	18	1
	<i>Armor Value</i>	
Front	6	
R/L Side	4/4	
Rear	2	
Rotor	2	

Weapons and Ammo	Location	Tonnage
Beagle Active Probe	Front	1.5
Large Laser	Front	5

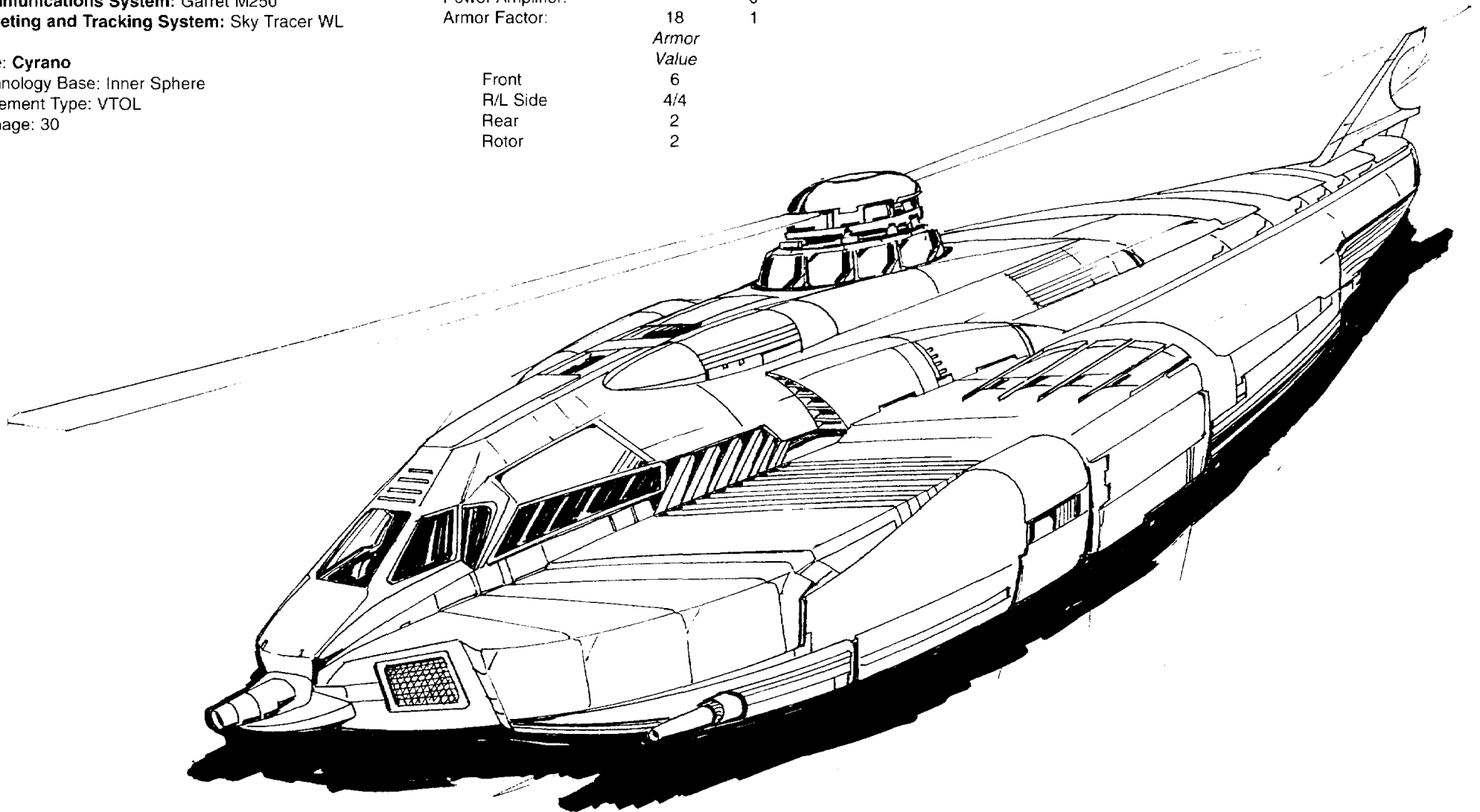

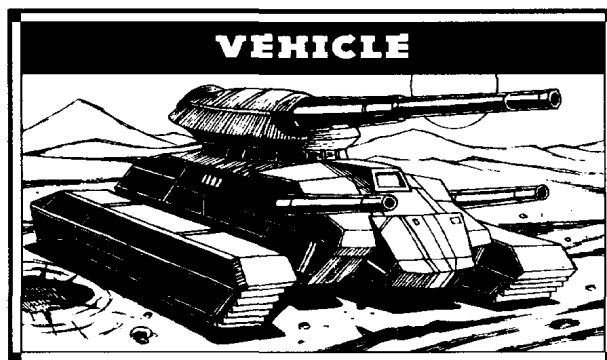

OVERVIEW

Designed in 2696 for the Star League Defense Force, this lightweight, high-speed hover strike craft plays a limited but important combat role. Carrying only light armor and weapons, the Lightning is not well-equipped to engage in protracted fire-fights, but its agility and advanced fire-control system allow it to close at high speed, maneuver into position and fire its small but accurate array of short-range weapons. It is usually employed as a strike force, harassing enemy forces—especially slow 'Mechs and vehicles—in the initial phases of a battle to break up enemy formation and cause general confusion. The Lightning has few other uses, however, as it is not well-equipped to perform reconnaissance and too poorly armed and armored for more traditional combat.

The 35-ton Lightning has a maximum speed of more than 175 kph and carries a special collision-avoidance radar and computer system to keep from crashing into trees and other obstacles. This system can be overridden in combat when the pilot needs to get closer to targets.

Designed to do extensive damage in short-range combat, the Lightning carries two Raker-IV medium pulse lasers and two Maxima SRM-4 One-Shot SRM launchers. It carries a mere three tons of ferro-fibrous armor. However, the hovercraft is extremely maneuverable, thanks to special thrusters mounted at various points along its hull that utilize the craft's high pressure air system.

Added to its sleek, low hull is a set of wings mounted near the rear. These wings provide added lift and stability at high speeds. The wings have elevators that allow the fast-moving vehicle to jump over low obstacles. Moving at top speed, the hovercraft has been able to clear two-meter fences in tests, but this has proven to be a difficult and dangerous maneuver in practice.

The Lightning was not designed for extended missions, and so has a cramped crew compartment. A driver sits at the front of the T-shaped area and a gunner and commander sit side by side right behind him. The tiny crew compartment also limits the amount of personal gear and supplies that the craft can carry.

Mass: 35 tons
Movement Type: Hover
Power Plant: GM 210
Cruising Speed: 119 kph
Flank Speed: 184 kph
Armor: Star Slab/3 Ferro-Fibrous
Armament:
 2 Raker-IV Medium Pulse Lasers
 2 Maxima One Shot SRM-4 Missile Racks
Manufacturer: Curtiss Industries
Communications System: Century Model 770
Targeting and Tracking System: TGI 2331C/TGI F-190

Type: **Lightning**
 Technology Base: Inner Sphere
 Movement Type: Hover
 Tonnage: 35

Equipment		Mass
Internal Structure:		3.5
Engine:	210	13.5
Type:	Fusion	
Cruising MP:	11	
Flank MP:	17	
Heat Sinks:	10	0
Control Equipment:		2
Lift Equipment:		3.5
Power Amplifier:		0
Turret:		0
Armor Factor:	63	3.5
	<i>Armor</i>	
	<i>Value</i>	
Front	20	
R/L Side	16/16	
Rear	11	

Weapons and Ammo	Location	Tonnage
Medium Pulse Laser	Front	2
Medium Pulse Laser	Front	2
SRM 4 (OS)	Right	2.5
SRM 4 (OS)	Left	2.5

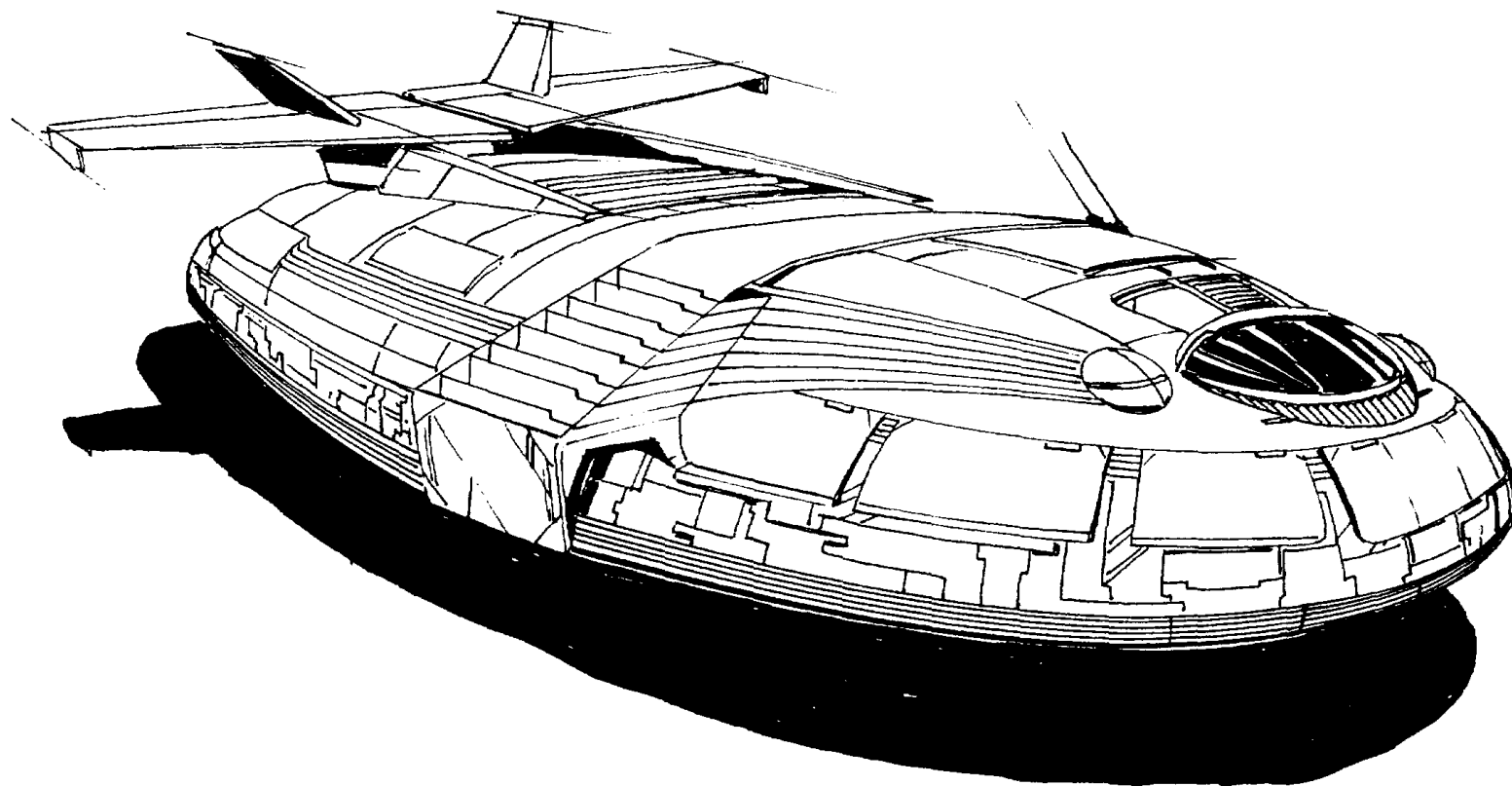

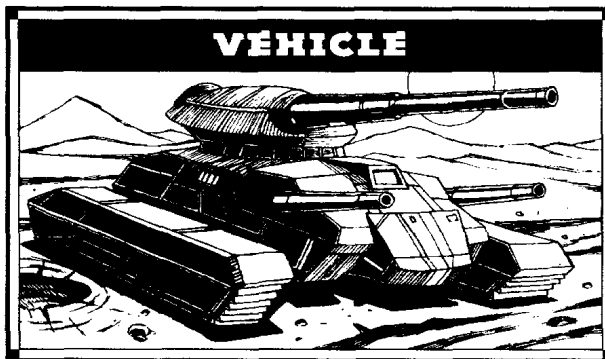

OVERVIEW

Originally designed in 2620 as a medium-duty hover tank, the Zephyr was equipped with a Guardian ECM Suite in order to help set up ambushes with the then-new Chaparral missile tank. The Zephyr has since taken on the role of screening friendly vehicles, including the Chaparral, by jamming enemy sensors. With a speed of 146 kph, the 40-ton hovercraft can easily keep up with the tanks it is designed to protect. Its Guardian system is a broad-band jamming device that obscures sonar, radar, UV, IR, and magscan readings. The system creates an electronic cloud that hides the sensor profiles of everything within a 180-meter radius of the hovercraft, making it difficult to track their movements.

The Zephyr's seven tons of ferro-fibrous armor is adequate to defend the jamming device, but it lacks enough firepower to justify risking the expensive Guardian system by placing the hover tank in battle. The Zephyr is equipped, however, with three Sorenstein IV medium lasers and a Shannon SRM-6 missile launcher that can be used to clear a path for the vehicle or to deal with any close threats. The Zephyr also carries a small laser mounted in the rear of the vehicle to provide cover when fleeing the field.

The Zephyr has one variant, the original version designed without the Guardian ECM. It carries an additional half-ton of armor on the front and an additional rear-facing, SRM-2 missile launcher with 50 missile rounds.

Mass: 40 tons
Movement Type: Hover
Power Plant: GM 185
Cruising Speed: 97 kph
Flank Speed: 151 kph
Armor: Grumman CRT Ferro-Fibrous
Armament:
 3 Sorenstein IV Medium Lasers
 1 Shannon SRM-6 Missile Rack
 1 Harmon Small Laser
Manufacturer: Grumman Industries
Communications System: Guardian ECM Suite
Targeting and Tracking System: Alloran Target Acquisition Gear

Type: **Zephyr**
 Technology Base: Inner Sphere
 Movement Type: Hover
 Tonnage: 40

Equipment		Mass	
Internal Structure:		4	
Engine:	185	11.25	
Type:	Fusion		
Cruising MP:	9		
Flank MP:	14		
Heat Sinks:	10	0	
Control Equipment:		2	
Lift Equipment:		4	
Power Amplifier:		0	
Turret:		.5	
Armor Factor:	125	7	
		<i>Armor Value</i>	
Front		29	
R/L Side		24/24	
Rear		19	
Turret		29	

Weapons and Ammo	Location	Tonnage
Medium Laser	Turret	1
Medium Laser	Turret	1
Medium Laser	Turret	1
TAG	Turret	1
SRM 6	Front	3
Ammo (SRM) 30	Body	2
Small Laser	Rear	.5
Guardian ECM Suite	Body	1.5
Cargo	Body	.25

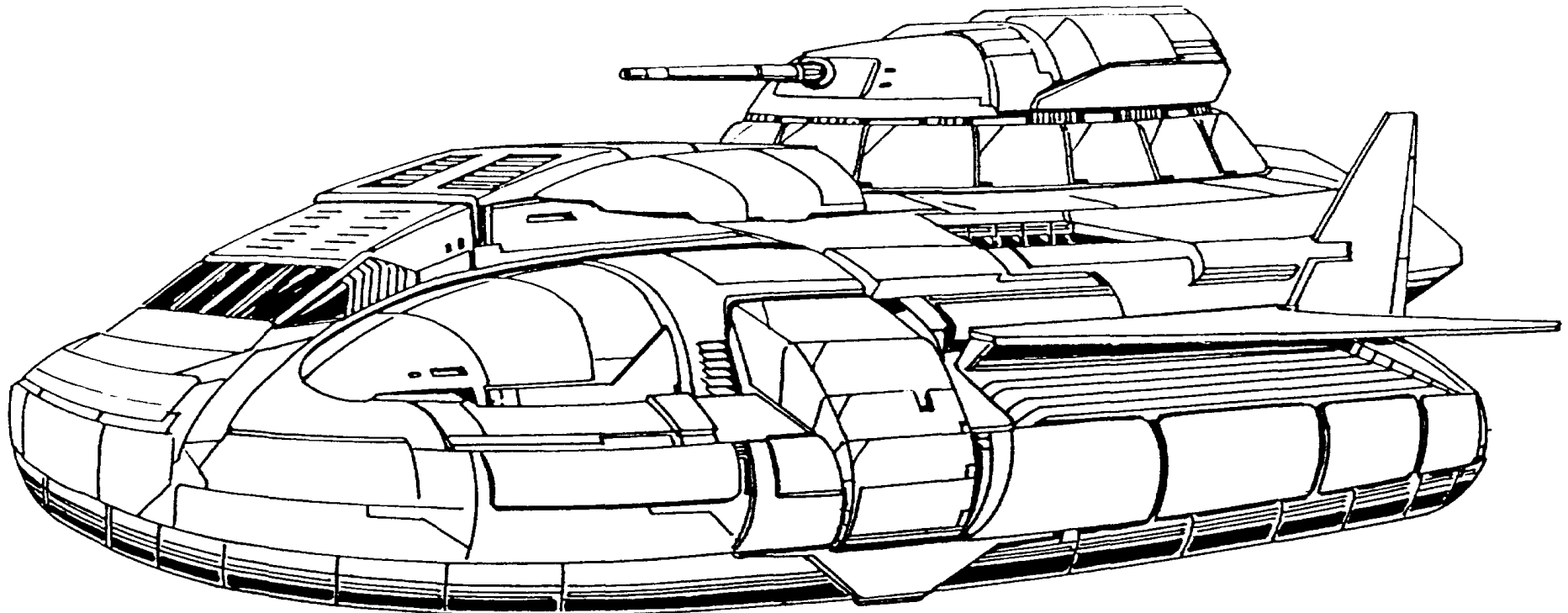

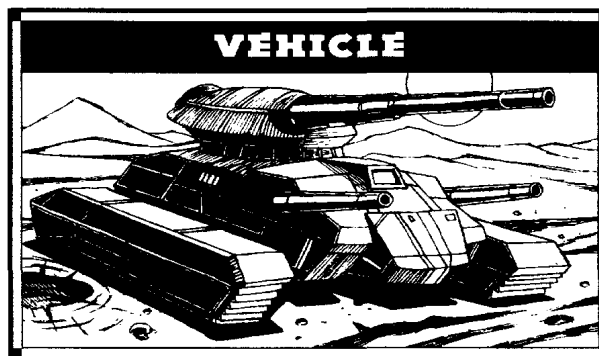

OVERVIEW

The light-weight Chaparral was introduced in 2611 as a tracked missile tank to serve among mobile units where self-propelled Long Toms and Snipers could not travel. The vehicle's heavy power made it popular; however, thanks to the fact that its weapons are shorter ranged than traditional artillery guns, the vehicle must operate nearer the front lines. The 50-ton tank carries a total of 5.5 tons of slab armor, mainly on the sides and back. The heavy armor and a flank speed of 65 kph enable the vehicle to survive most close encounters, a fact that makes it exceedingly popular with its crews.

The Chaparral's main armor is the Arrow IV surface-to-surface missile system, consisting of two launchers mounted in pods that elevate just before firing. They then lower to their normal positions, returning the Chaparral to its normally low profile. The Arrow IV missiles come in two varieties, those that home in on signals from Target Acquisition Gear (TAG) and those that explode over a wider area. These missiles are much more expensive than the equally destructive rounds for Long Toms, Snipers, or Thumpers, but the Chaparral complements infantry and light armored units because it need not be in the immediate zone of combat.

A small array of defensive weapons protects the Chaparral when an enemy gets into closer range. Two Sapphire medium lasers mounted on the sides of the hull and a rear-firing Shrike SRM-6 missile launcher concentrate firepower in the vehicle's rear arc, as the vehicle fights at close range only in retreat.

The four-man crew, consisting of a driver, gunner, radio operator, and tank commander, is housed just forward of the missile launcher. The fusion engine precludes fuel problems, allowing the vehicle to operate for extended periods of combat. Chaparrals also have a good service record, with a low breakdown rate.

Mass: 50 tons
Movement Type: Tracked
Power Plant: Nissan 200
Cruising Speed: 43 kph
Flank Speed: 65 kph
Armor: Star Slab/1
Armament:
 2 Sapphire Medium Lasers
 1 Shrike SRM-6 Missile Rack
 2 AIL Arrow IV Launchers
Manufacturer: Grumman Industries
Communications System: TransComm 12
Targeting and Tracking System: TransComm WDS40A

Type: Chaparral
Technology Base: Inner Sphere
Movement Type: Tracked
Tonnage: 50

Equipment		Mass
Internal Structure:		5
Engine:	200	12.75
Type:	Fusion	
Cruising MP:	4	
Flank MP:	6	
Heat Sinks:	10	0
Control Equipment:		2.5
Lift Equipment:		0
Power Amplifier:		0
Turret:		0
Armor Factor:	88	5.5
	<i>Armor Value</i>	
Front		16
R/L Side		18/18
Rear		36

Weapons and Ammo	Location	Tonnage
Medium Laser	Right	1
Medium Laser	Left	1
SRM 6	Rear	3
Ammo (SRM) 15	Body	1
Arrow IV System	Front	15
Ammo (Arrow IV) 15	Body	3
Cargo	Body	.25

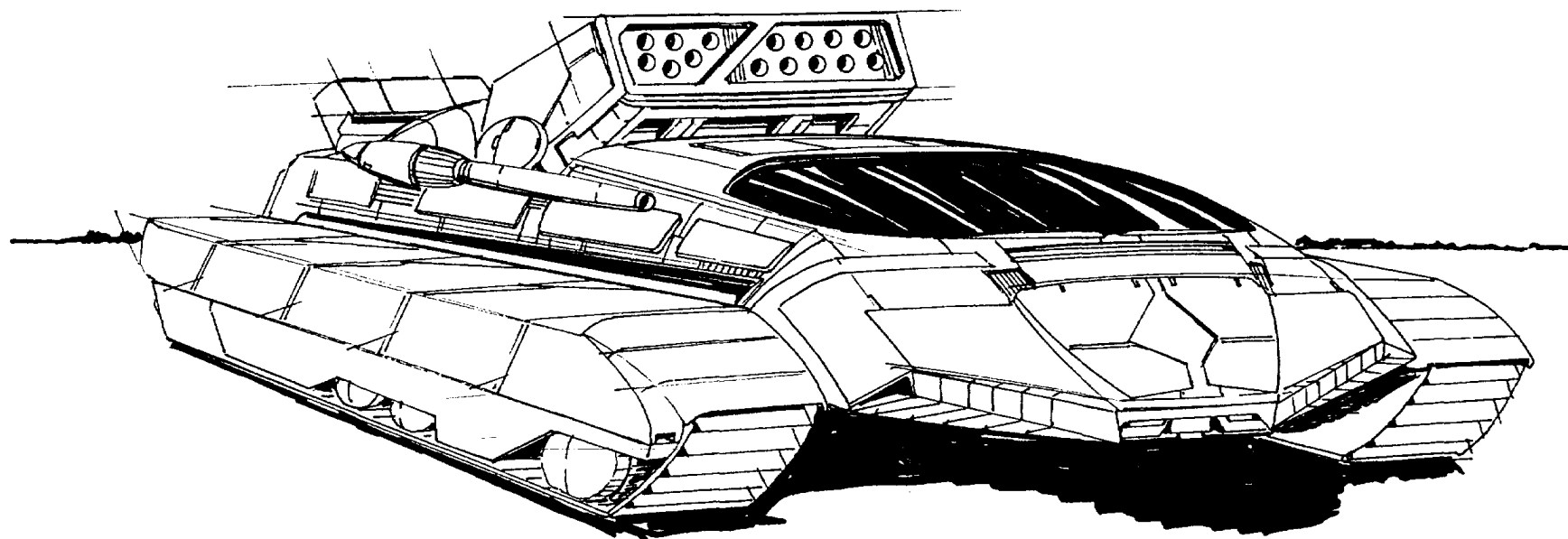

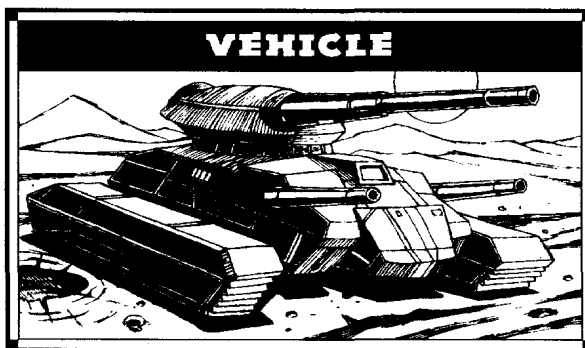

OVERVIEW

Developed in 2650 to take advantage of most BattleMechs' inferior mobility, the Kanga was designed to deliver effective firepower with the speed and agility of a hovercraft equipped with jump jets. The added maneuverability made it one of the most successful vehicles in the Star League Army.

Even without the Mitchell JB jump jets set on the sides of its keel, this 50-ton vehicle would be an efficient hover tank. It has a respectable flank speed of 130 kph, and the jump jets allow it to clear 180 meters. The Kanga's special jump jets were designed so that the Janzen International combustion engine could recharge their thrust bottles. The jets perform well, but the skimpiness of the side armor protecting the thrust bottles makes them vulnerable to attack. Though adequate in most respects, the Kanga's Durolex armor is weaker on the sides of the tank's body to make room for the thrust bottles.

The tank's weapons include a Lonworth Type V autocannon for long-range attacks, an LRM/SRM vertical launch system imbedded in the central portion of the hover tank's body, and a Tri-Axe machine gun tucked into a cupola in the commander's position. Because it has no turret, the Kanga has a low silhouette, making it a somewhat more difficult target to hit.

The vehicle's targeting and tracking computer includes an inertial guidance and gyro system that solves the balancing problems inherent in most hovering and jumping maneuvers. It automatically handles all routine functions, including gyro-stability during jumps and hover maneuvers. The computer can also operate the vehicle independently on a preprogrammed mission if needed. Manual CDC components are slaved to the computer, allowing the simultaneous targeting of up to four enemy vehicles or installations, even during complicated jump maneuvers or evasive tactics.

Kangas are usually deployed in groups of four, and are often held in reserve for reconnaissance or assault in difficult terrain. One of the few vehicles that can match a 'Mech's mobility, they also frequently support 'Mech lances. Jump maneuvers allow the hovercraft to target weak spots in enemy machines, but defenders can deploy a second line of attack to assail the Kangas as they jump to fire on their intended targets.

Mass: 50 tons
Movement Type: Hover/Jump
Power Plant: VOX 165 Internal Combustion
Cruising Speed: 86 kph
Flank Speed: 130 kph
Jump Jets: Mitchell JB Thrust Bottles
Jump Capacity: 180 meters

Armor: Durolex

Armament:

- 1 Lonworth Type V Autocannon
- 1 General Datatech Vertical Launch LRM-10 Missile Rack
- 1 General Datatech Vertical Launch SRM-4 Missile Rack
- 1 Tri-Axe Machine Gun

Manufacturer: Mitchell Vehicles

Communications System: Stony AIX

Targeting and Tracking System: AL2200

Type: **Kanga**
 Technology Base: Inner Sphere
 Movement Type: Hover
 Tonnage: 50

Equipment		Mass
Internal Structure:		5
Engine:	165	12
Type:	ICE	
Cruising MP:	8	
Flank MP:	12	
Jumping MP:	6	
Heat Sinks:	0	0
Control Equipment:		2.5
Lift Equipment:		5
Power Amplifier:		0
Turret:		0
Armor Factor:	56	3.5
	<i>Armor Value</i>	
Front	20	
R/L Side	12/12	
Rear	12	

Weapons and Ammo	Location	Tonnage
AC/5	Front	8
Ammo (AC) 20	Body	1
LRM 10	Front	5
Ammo (LRM) 12	Body	1
SRM 4	Front	2
Ammo (SRM) 25	Body	1
Machine Gun	Front	.5
Ammo (MG) 100	Body	.5
Jump Jets	Body	3

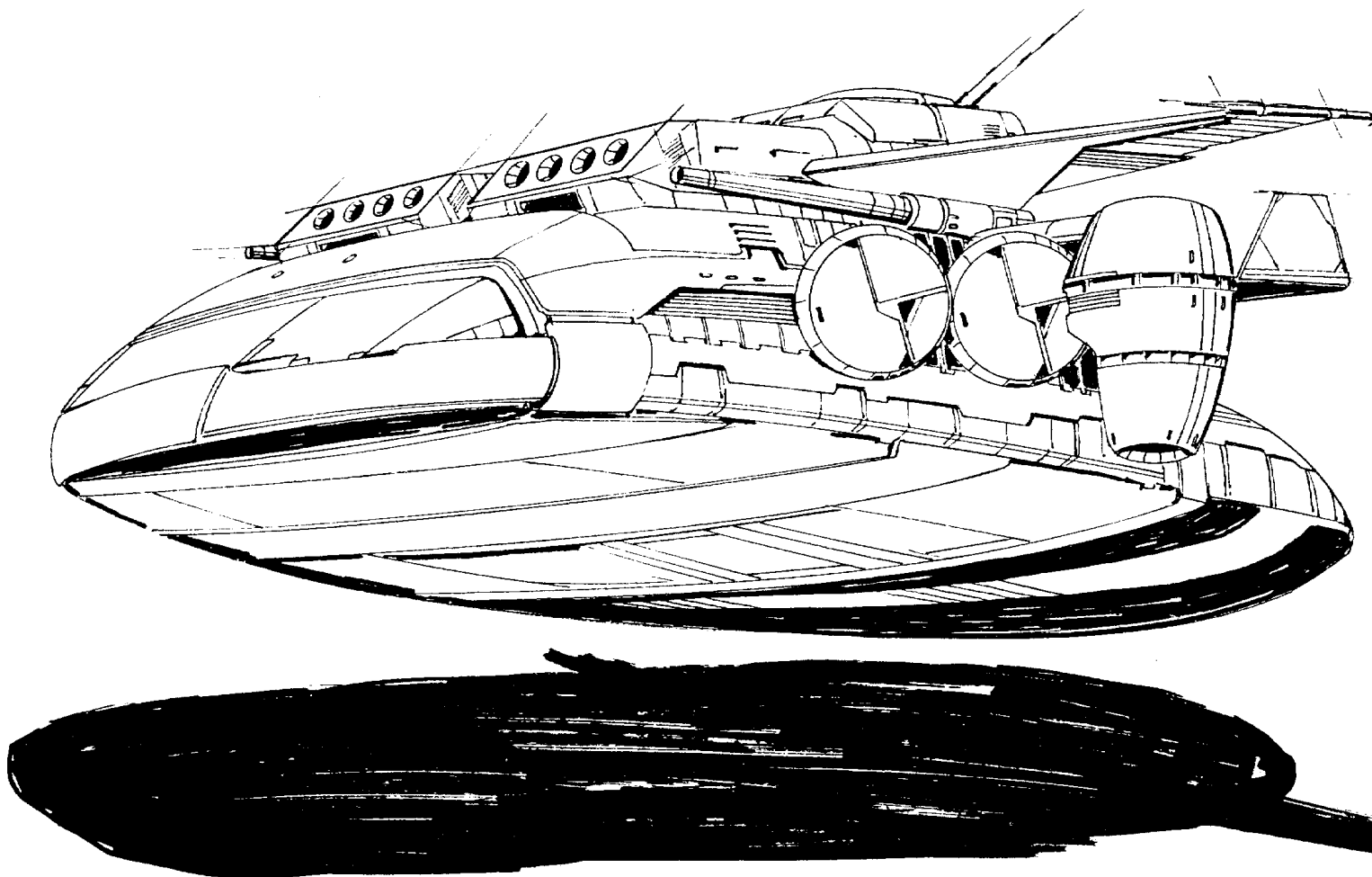

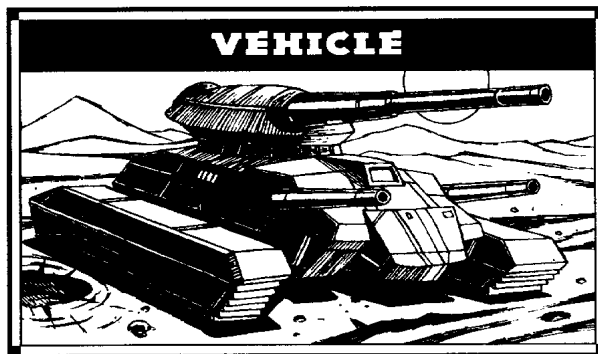

OVERVIEW

Designed in 2680, the Thor was built to fill the need for quick artillery response on a fluid battlefield. Weighing in at 55 tons and with a speed of 81 kph, the wheeled vehicle was created to carry the Thumper artillery piece into battle.

Though the Thor carries a respectable 7.5 tons of ferro-fibrous armor and has Cellular Ammunition Storage Equipment to guard against internal shell explosions, the vehicle relies primarily on its speed for defense. Though it cannot fire when moving, setting up its firing station requires less than 60 seconds, and the vehicle can be on the move again in under half a minute.

The Thumper artillery piece, though light, has excellent range and a fast rate of fire. Groups of Thumpers have been known to level a city block in a matter of minutes. The tank's trans-optical aiming system, which links the spotter to the artillery piece, contains some of the most advanced communications equipment in existence.

The Thor also sports twin Magna LT medium lasers in its turret, giving some resistance if the enemy comes too close. The lasers provide some defensive capability, but not in a prolonged engagement. The crew of a Thor has a better chance of surviving if they put some distance between themselves and the enemy, allowing them to use the longer-range Thumper.

The Cellular Ammunition Storage Equipment provides excellent crew protection in case of an ammunition explosion. The shell storage compartment is lined with ferro-fibrous plating on five sides, which channels the explosion toward the sixth side if a chamber rupture occurs. The explosion blows out the rear armor and cripples the vehicle, but the crew of the Thor usually survives.

Mass: 55 tons
Movement Type: Wheeled
Power Plant: Strand 255
Cruising Speed: 54 kph
Flank Speed: 81 kph
Armor: Ulston105 Ferro-Fibrous with CASE
Armament:

Weapons and Ammo	Location	Tonnage
Thumper	Front	15
Ammo (Thumper) 40	Body	2
CASE	Body	.5
Medium Laser	Turret	1
Medium Laser	Turret	1

1 Thumper Artillery Piece
 2 Magna LT Medium Lasers
Manufacturer: Ulston Armor
Communications System: RedStar III
Targeting and Tracking System: TBR LaserTrac

Type: Thor
 Technology Base: Inner Sphere
 Movement Type: Wheeled
 Tonnage: 55

Equipment	Mass
Internal Structure:	5.5
Engine:	19.5
Type:	Fusion
Cruising MP:	5
Flank MP:	8
Heat Sinks:	0
Control Equipment:	2.75
Lift Equipment:	0
Power Amplifier:	0
Turret:	0.2
Armor Factor:	7.5
	<i>Armor Value</i>
Front	30
R/L Side	25/25
Rear	24
Turret	30

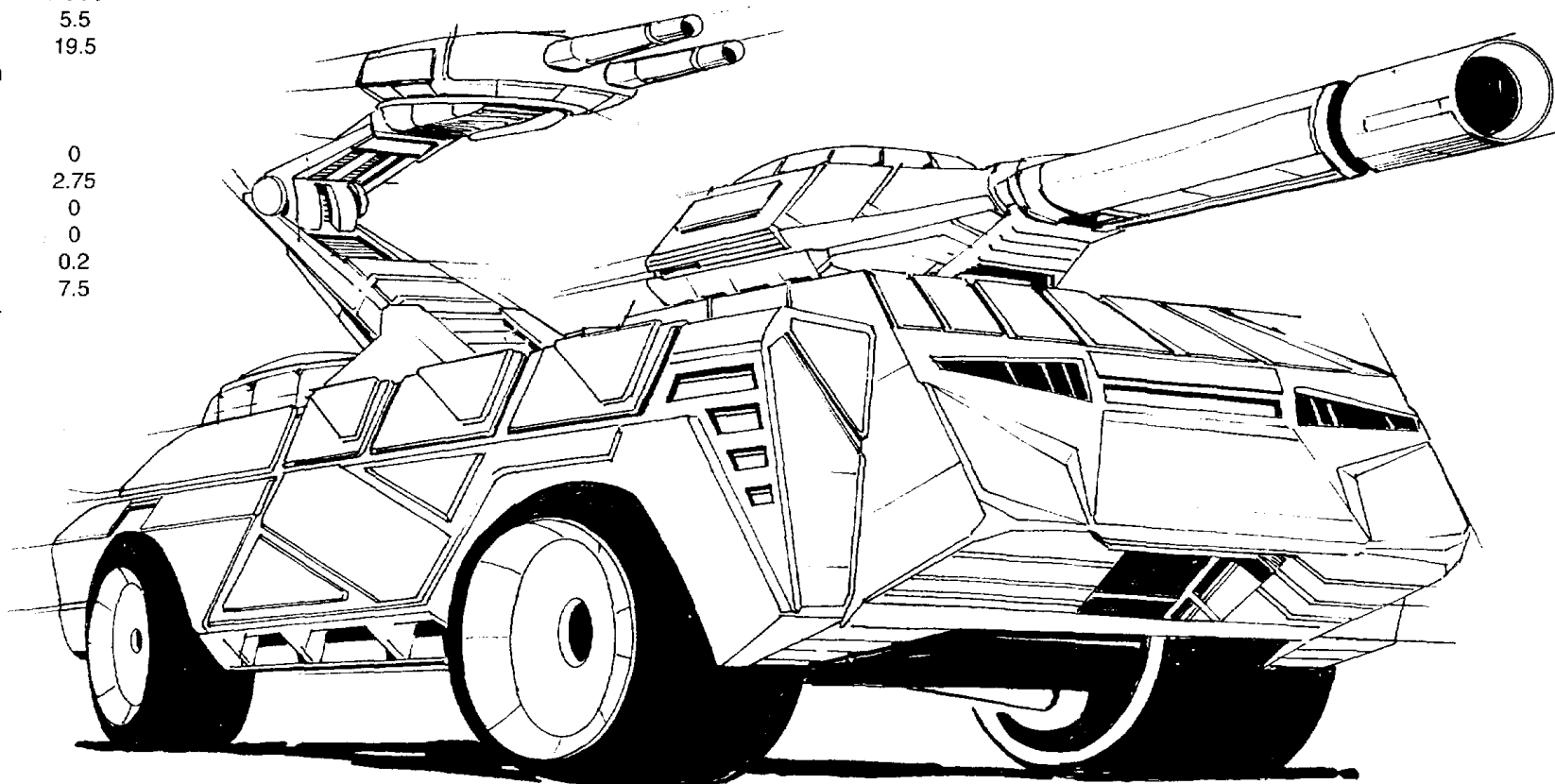

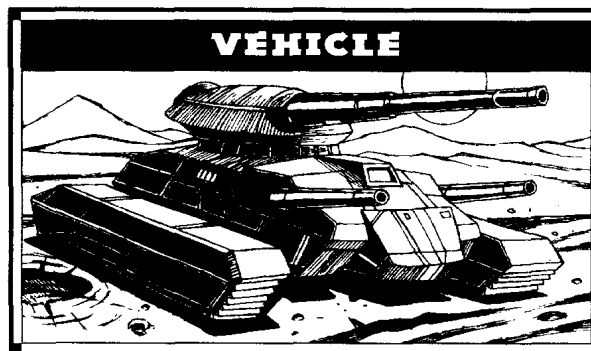

OVERVIEW

Introduced in 2716, the Demon soon became the SLDF's standard fighting vehicle for engaging light and medium 'Mechs. With respectable maneuverability, a flank speed of 65 kph, substantial armor, and a powerful Gauss rifle mounted in the turret, the Demon was admirably suited for this purpose, and also for surprise attacks. Pairs of Demons will often wait for days to ambush a target, charging from cover for a surprise frontal assault.

The 60-ton Demon carries the M-7 Gauss rifle, which uses electromagnets to propel the shell down the barrel. This creates little heat, but requires tremendous amounts of power and space. However, the weapon provides excellent firepower, and the turret guarantees a 360-degree field of fire.

The Gauss rifle is augmented with two Intek medium lasers, mounted on the vehicle's sides, and a forward-firing Harpoon-6 short-range missile system. These systems are housed in the body of the vehicle, providing excellent secondary fire against close-assault attacks. A Cellular Ammunition Storage Equipment system protects the missile loads from enemy fire.

Ten tons of PanzerSlab 2 armor, concentrated mainly on the front, makes the Demon ideal for a head-on attack. The sides and turret carry a standard load of armor, but the vehicle's poorly protected back leaves it open to rear attacks by light 'Mechs that manage to sneak behind it.

The Horned Demon variant replaces the short-range missile launcher and CASE system with two additional forward-firing medium lasers on the front of the vehicle and adds two extra heat sinks. The change provides excellent frontal attack ability at the expense of side protection, leaving the vehicle vulnerable in open engagement. Horned Demons are rarely deployed except in defensive positions.

Mass: 60 tons
Movement Type: Wheeled
Power Plant: DAV 220
Cruising Speed: 43 kph
Flank Speed: 65 kph
Armor: PanzerSlab 2 with CASE
Armament:
 1 M-7 Gauss Rifle
 2 Intek Medium Lasers
 1 Harpoon SRM-6 Missile Rack
Manufacturer: Leopard Armor
Primary Factory: Terra
Communications System: Teledon 19
Targeting and Tracking System: Baltex K590

Type: Demon
 Technology Base: Inner Sphere
 Movement Type: Wheeled
 Tonnage: 60

Equipment		Mass
Internal Structure:		6
Engine:	220	15
Type:	Fusion	
Cruising MP:	4	
Flank MP:	6	
Heat Sinks:	10	0
Control Equipment:		3
Lift Equipment:		0
Power Amplifier:		0
Turret:		1.5
Armor Factor:	160	10
	<i>Armor Value</i>	
Front	50	
R/L Side	30/30	
Rear	20	
Turret	30	

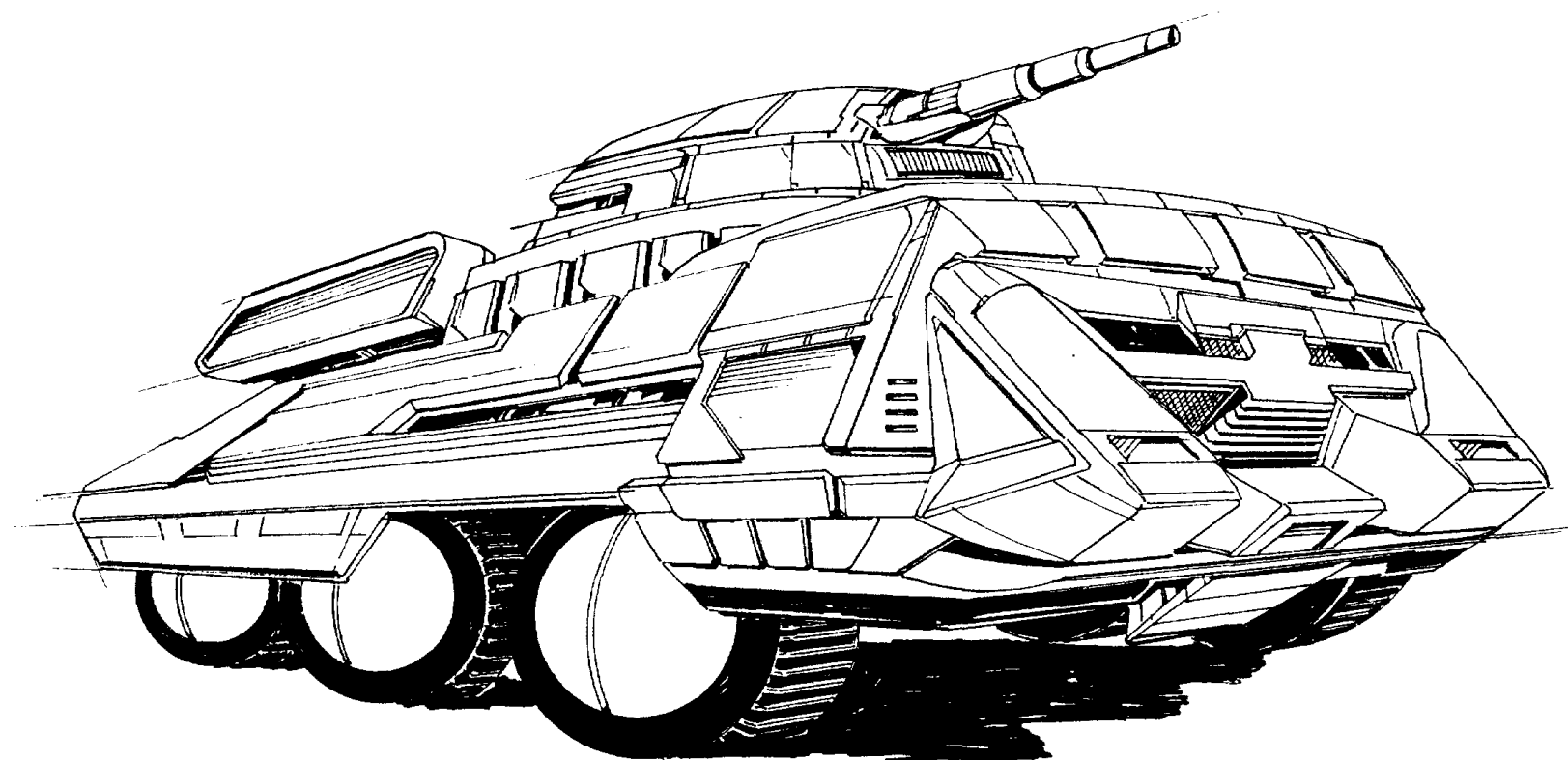

Weapons and Ammo	Location	Tonnage
Gauss Rifle	Turret	15
Ammo (Gauss) 16	Body	2
Medium Laser	Left	1
Medium Laser	Right	1
SRM 6	Front	3
Ammo (SRM) 30	Body	2
CASE	Body	.5

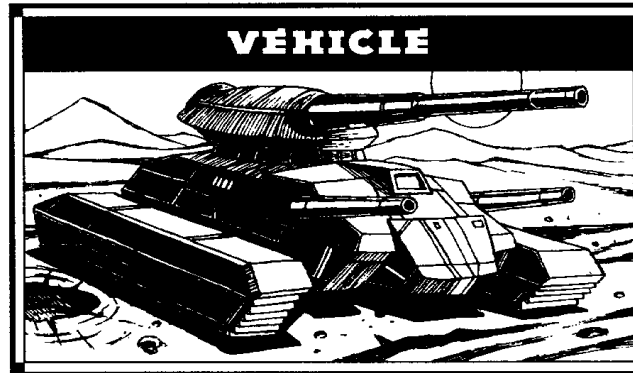

OVERVIEW

When vehicle designers attempted to replace the Thor tank's Thumper artillery piece with the heavier Sniper artillery, the added weight forced them to create a new carrier—the Marksman, first produced in 2702. Tracks replaced wheels to better support the Sniper's weight and provide stability, and the designers also sacrificed speed for additional armor. The resulting 65-ton vehicle has a maximum flank speed of 65 kph, but can handle most terrain it encounters. Faulty tread locks on the inner tracks of the original vehicle gave it a less-than-spotless reputation, but this flaw was corrected in subsequent models. To offset the tank's inability to outrun its enemies, the Marksman's designers included 7.5 tons of ferro-fibrous armor, much of it concentrated in the front.

The tank's primary weapon is the Sniper, the Star League Defense Force's standard medium-duty artillery piece. Its range is short for an artillery piece, but it can create more havoc than most. The Marksman's secondary weapon is a large laser mounted in the turret. It has a reputation for accuracy even at long range because it is tied to the vehicle's sophisticated tracking system.

The Sniper's relatively short range ensures that the Marksman is more likely to see combat than most other tracked vehicles. To exploit the Sniper's advantages to the fullest, the vehicle carries a second computer that controls the Sniper for direct fire. This independent target-tracking computer can speedily lock onto its target, giving the Sniper deadly direct-fire capabilities.

Mass: 65 tons
Movement Type: Tracked
Power Plant: Magna 260
Cruising Speed: 43 kph
Flank Speed: 65 kph
Armor: Grumman CRT Ferro-Fibrous
Armament:
 1 Sniper Artillery Piece
 1 RAMTech 500 Large Laser
Manufacturer: Grumman Industries
Communications System: O/P GRD 300
Targeting and Tracking System: O/P GRD059

Type: Marksman
Technology Base: Inner Sphere
Movement Type: Tracked
Tonnage: 65

Equipment		Mass
Internal Structure:		6.5
Engine:	260	20.25
Type:	Fusion	
Cruising MP:	4	
Flank MP:	6	
Heat Sinks:	10	0
Control Equipment:		3.25
Lift Equipment:		0
Power Amplifier:		0
Turret:		.5
Armor Factor:	134	7.5
	<i>Armor Value</i>	
Front	54	
R/L Side	20/20	
Rear	20	
Turret	20	

Weapons and Ammo	Location	Tonnage
Sniper	Front	20
Ammo (Sniper) 20	Body	2
Large Laser	Turret	5

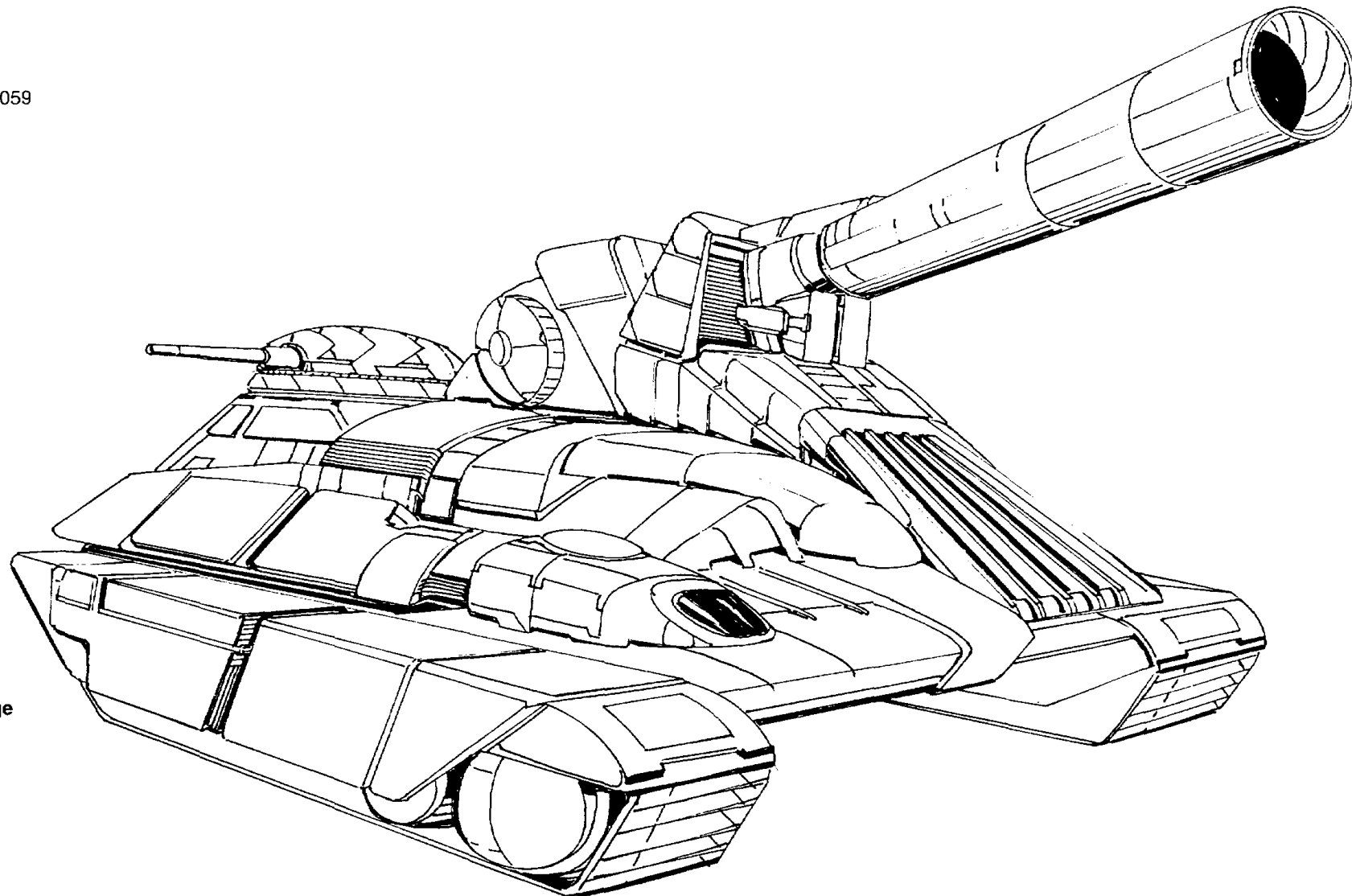

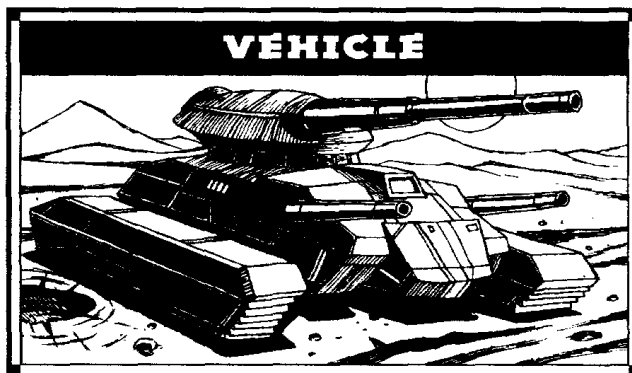

OVERVIEW

Although the design stage of the Magi was marked with scandal and charges of favoritism, the prototypes performed well under stringent testing and entered full production in 2727. The tank played an effective role as an anti-infantry vehicle and in dealing with the civil unrest of the time. Weighing in at 70 tons, with a flank speed of 81 kph, the Magi tank is well-suited for its intended role.

The vehicle mounts nine and one-half tons of ferro-fibrous armor, which was originally designed for BattleMechs. This armor has not been completely successful on the Magi, as abrupt maneuvers have been known to cause hairline cracks between the armor plates. However, it does provide more protection than other types of armor—a fair trade-off, according to most pilots.

Its main weapons are three Randall Hellbitch medium lasers mounted to the front, left, and right. The system lacks the concentrated firepower of most tanks, but the fire-control system was among the most advanced at the time of its conception. With three independent target-acquisition computers, the Magi can fire in three directions at the same time, allowing it to engage a number of foes simultaneously. However, it lacks the knockout punch needed against armored targets. The twin Ramsey-65 machine guns normally fire with the front laser.

The Cellular Ammunition Storage Equipment system, which houses the machine gun ammunition, protects the storage racks with sheets of ferro-fibrous armor.

Mass: 70 tons
Movement Type: Tracked
Power Plant: Magna 350
Cruising Speed: 54 kph
Flank Speed: 81 kph
Armor: Killosh Xtra-Weave Ferro-Fibrous
Armament:
 3 Randall Hellbitch Medium Lasers
 2 Ramsey-65 Machine Guns
Manufacturer: Killosh Industries
Communications System: Hesperus 5GT
Targeting and Tracking System: Lynx RM

Weapons and Ammo	Location	Tonnage
Medium Laser	Front	1
Medium Laser	Right	1
Medium Laser	Left	1
Machine Gun	Front	.5
Machine Gun	Front	.5
Ammo (MG) 200	Body	1
CASE	Body	.5
Cargo	Body	.25

Type: Magi
 Technology Base: Inner Sphere
 Movement Type: Tracked
 Tonnage: 70

Equipment	Mass
Internal Structure:	7
Engine:	44.25
Type:	350 Fusion
Cruising MP:	5
Flank MP:	8
Heat Sinks:	10 0
Control Equipment:	3.5
Lift Equipment:	0
Power Amplifier:	0
Turret:	0
Armor Factor:	170 9.5
	<i>Armor Value</i>
Front	44
R/L Side	43/43
Rear	40

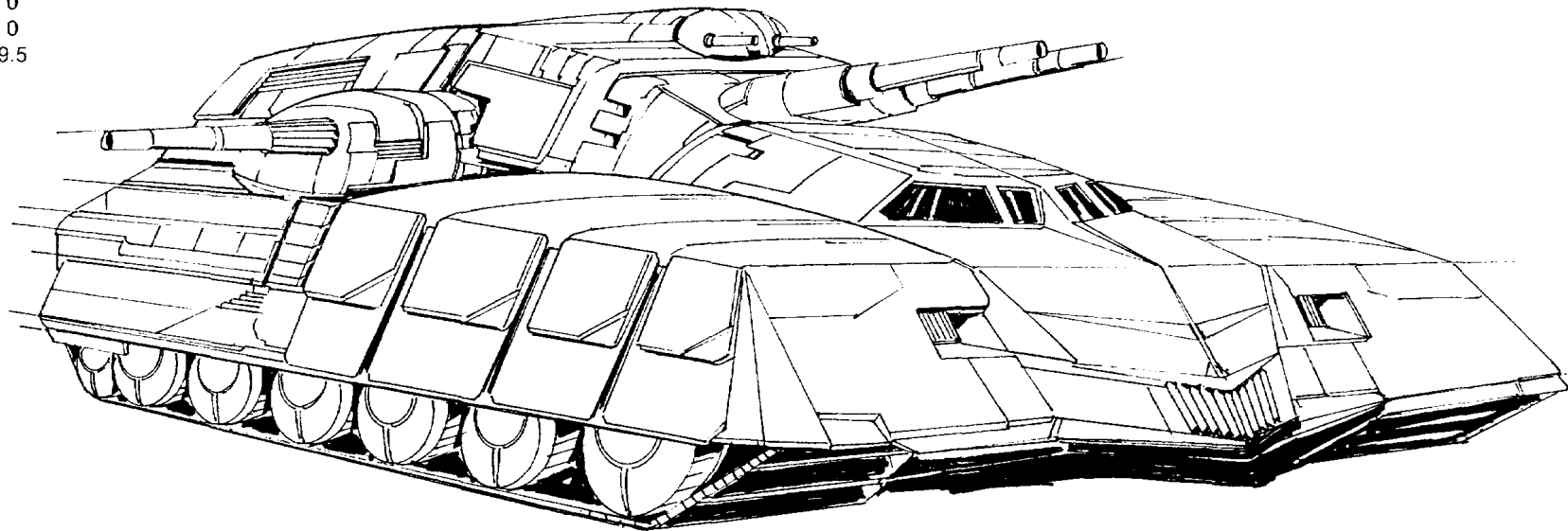

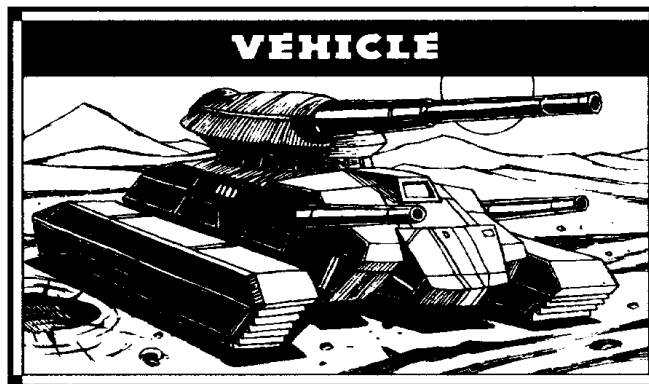

OVERVIEW

A threat to all but the heaviest of 'Mechs, the Burke was designed in 2580 for static defense against its enemies. Loaded with weapons at the expense of speed, with a maximum flank speed of 32 kph, the Burke cannot offer much in the way of pursuit.

What the Burke lacks in speed, however, it more than makes up for in firepower. Its primary weapon is triple-mounted Chalker Model 25 particle cannons, a vast improvement on the classic "one-two punch." Each of the three weapons can fire at a different target or they can fire in unison, making them a deadly combination. When all three PPCs hit at the same instant, they can overload a 'Mech's computer or cause enough electronic noise to temporarily jam communications or targeting data. Most SLDF BattleMechs carried dampers to channel out such power bursts, but many owned by the Successor States do not.

The Burke also carries the Holly-10 long-range missile launcher. Known as the "Holly-Rack," it is one of the most powerful Hollys ever produced. When working in conjunction with the Burke's Scope 30 RNDST targeting and tracking system, it accounts for trajectory, ECM, atmospheric conditions and target movement. Because of its limited number of reloads, the Holly-Rack is used only as a backup system for the PPCs.

In a quick fight against a single BattleMech, the Burke can hold its own. When faced with multiple opponents, however, the Burke is hobbled by its very strength, the concentration of firepower. With this flaw added to its poor maneuverability, the vehicle can easily become a sitting target for its opponents.

Mass: 75 tons

Movement Type: Tracked

Power Plant: GM 150

Cruising Speed: 22 kph

Flank Speed: 32 kph

Armor: Acbar 55 Ferro-Fibrous

Armament:

3 Chalker Model 25 PPCs

1 Holly LRM-10 Missile Rack

Manufacturer: Foretechno

Communications System: 1 Drivion 300

Targeting and Tracking System: Scope 30 RNDST

Weapons and Ammo	Location	Tonnage
PPC	Turret	7
PPC	Turret	7
PPC	Turret	7
LRM 10	Front	5
Ammo (LRM) 12	Body	1

Type: **Burke**

Technology Base: Inner Sphere

Movement Type: Tracked

Tonnage: 75

Equipment

Mass

Internal Structure:

7.5

Engine: 150

8.25

Type: Fusion

Cruising MP: 2

Flank MP: 3

Heat Sinks: 30

20

Control Equipment:

3.75

Lift Equipment:

0

Power Amplifier:

0

Turret: 2.5

Armor Factor: 108

6

Armor Value

Front 30

R/L Side 20/20

Rear 16

Turret 22

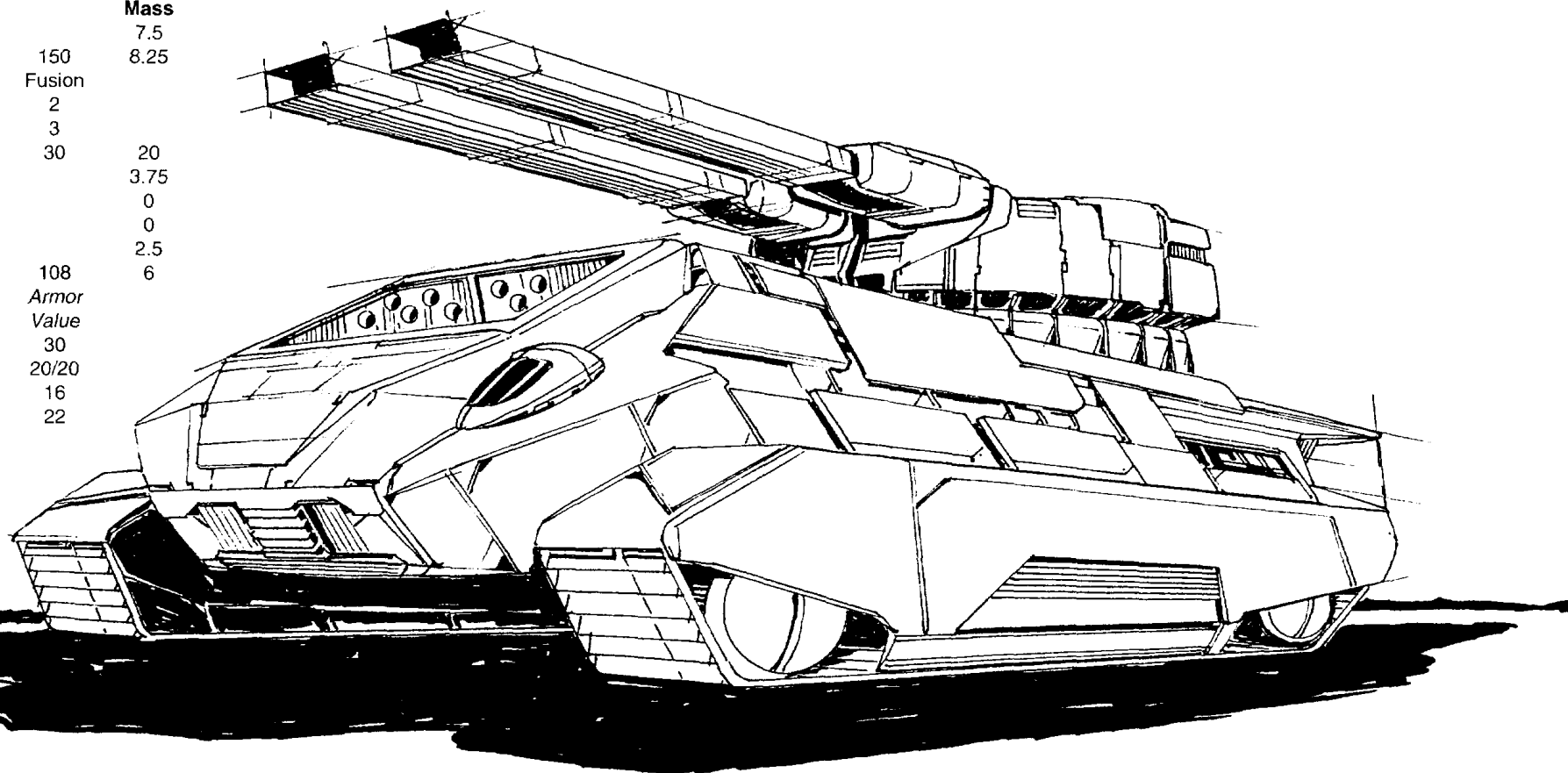

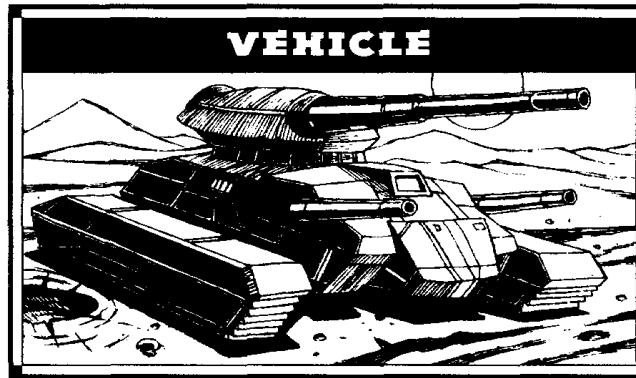

OVERVIEW

Designed in 2637 as a command vehicle for armor and infantry units, the expensive Fury was greeted with enthusiasm because of its protection, long-range firepower, and the fastest battlefield computer in the Inner Sphere.

Fifteen of the Fury's 80 tons are devoted to standard slab armor on a tracked chassis. Well-armored and solidly built, the tank can withstand considerable abuse, and its top flank speed of 65 kph is respectable for its size.

The vehicle's only weapon is the 1M-9 Gauss rifle in the turret, which gives it excellent range and firepower. However, it lacks the ability to stop a close-assault attack. The Fury was originally designed with an additional medium laser on a second turret, but procurement officers considered the additional weapon unnecessary for a command vehicle. Though the Gauss rifle is a powerful weapon, the system requires large amounts of shielding to protect the surrounding electronic components from the rifle's intense magnetic field.

The Fury contains a Nirasaki-400X command computer. Packed with six parallel processors, the 400X can easily monitor the battlefield operations of the entire battalion. When tied to the vehicle's communication system, the 400X tracks enemy troop movements, identifies suspected positions, and analyzes enemy goals. The complexity of the system requires the assignment of an extra computer specialist to the battalion command staff.

The Fury II variant removes the Nirasaki command computer and one ton of Gauss ammunition to make room for a forward-firing medium laser and half a ton of additional side armor. Usually deployed as a 'Mech hunter, the Fury II has become increasingly popular.

Mass: 80 tons

Movement Type: Tracked

Power Plant: Pitban 320

Cruising Speed: 43 kph

Flank Speed: 65 kph

Armor: PyroTec ArmorSlab

Armament:

1 M-9 Gauss Rifle

Manufacturer: Jolassa Armored Vehicles

Communications System: HIV-13

Targeting and Tracking System: Quadrant XD

Type: **Fury**

Technology Base: Inner Sphere

Movement Type: Tracked

Tonnage: 80

Equipment		Mass
Internal Structure:		8
Engine:	320	33.75
Type:	Fusion	
Cruising MP:	4	
Flank MP:	6	
Heat Sinks:	10	0
Control Equipment:		4
Lift Equipment:		0
Power Amplifier:		0
Turret:		1.5
Armor Factor:	240	15
	<i>Armor Value</i>	
Front	60	
R/L Side	40/40	
Rear	40	
Turret	60	

Weapons and Ammo	Location	Tonnage
Gauss Rifle	Turret	15
Ammo (Gauss) 16	Body	2
Cargo	Body	.75

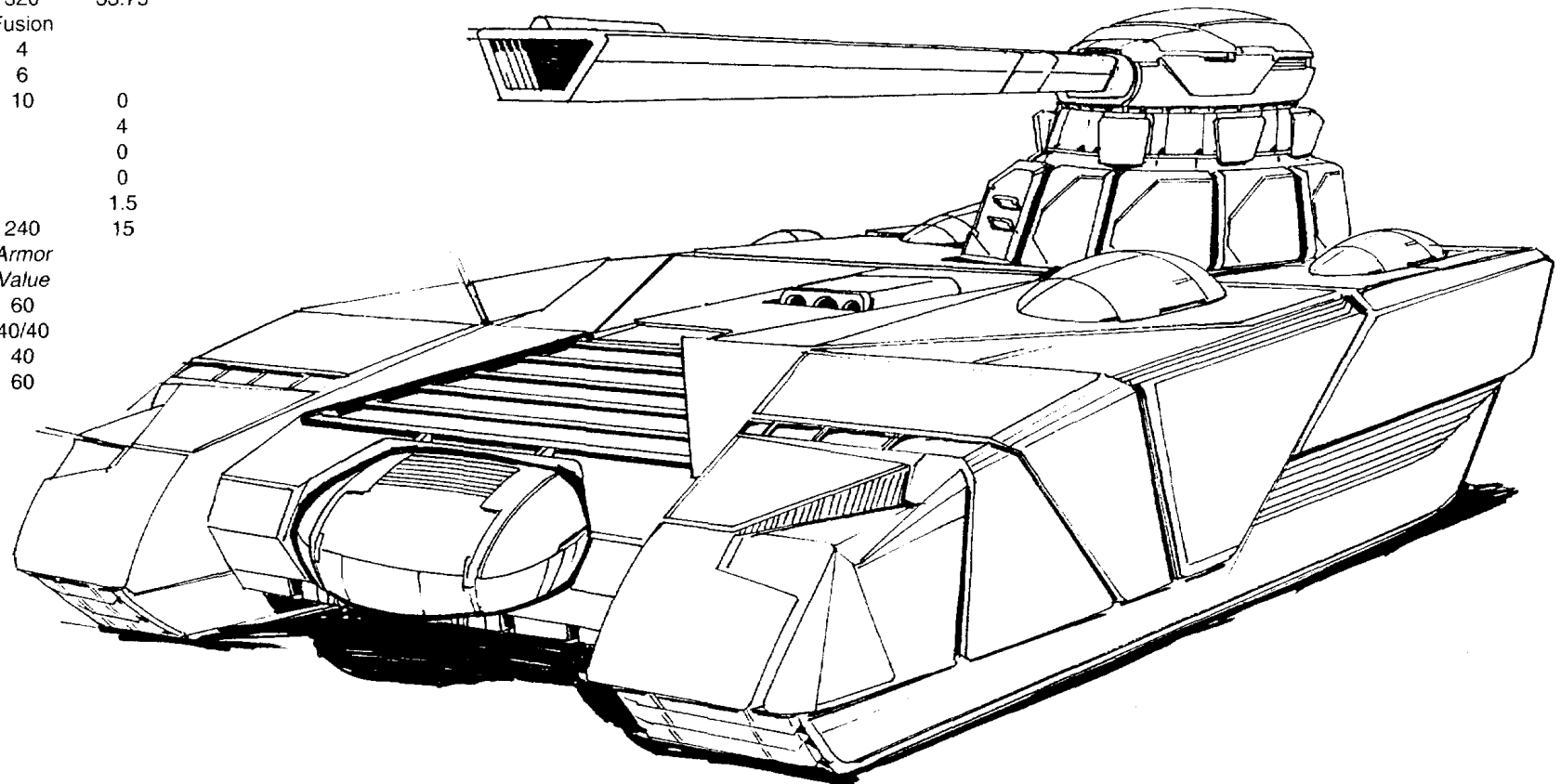

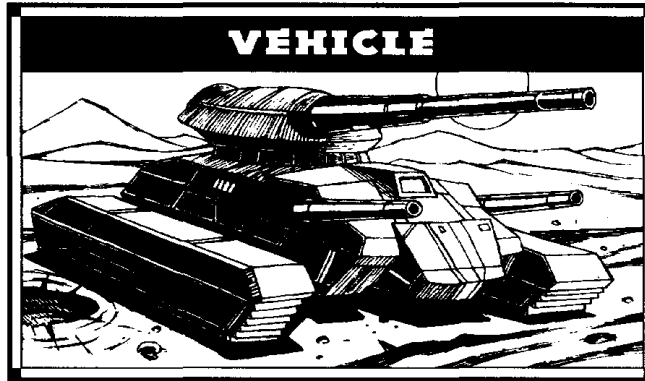

OVERVIEW

Sacrificing crew comfort and ammunition-storage protection for long-range weapon power, the Rhino is among the slowest military vehicles ever produced. Built in 2669 to anchor defensive lines, this hefty tracked vehicle weighs almost 80 tons and has a maximum speed of only 49 kph. Its lack of comfort makes it unlikely to win popularity contests with its crews; however, its variety of weapons and heavy armor make it a power to be reckoned with on the battlefield.

The Rhino impresses commanders with its smorgasbord of weapons and seventeen tons of thick Pantherskin VII slab armor. Though crew comfort is virtually nonexistent, the tank offers one of the most diverse weapon packages available in the Inner Sphere. Its primary weapons are twin Delta Dagger LRM-20 systems set in the turret and Conan DT-10 LRM launchers mounted in the hull. Two Starflash medium lasers, also mounted in the turret, round out the armaments and are very useful when the Rhino empties its long-range missile complement onto the enemy.

The LRM launchers provide heavy support for armored companies, effectively showering the enemy with the equivalent of a miniature artillery barrage. Unfortunately, the Rhino is not equipped with a Cellular Ammunition Storage Equipment system for missile reloads.

Mass: 80 tons
Movement Type: Tracked
Power Plant: Pitban 240
Cruising Speed: 32 kph
Flank Speed: 54 kph
Armor: Pantherskin VII
Armament:
 2 Delta Dagger LRM-20 Missile Racks
 2 Starflash Medium Lasers
 1 Conan DT LRM-10 Missile Rack
Manufacturer: Leopard Armor
Primary Factory: Terra
Communications System: Trannel GL5
Targeting and Tracking System: Trannel OT73L

Weapons and Ammo	Location	Tonnage
LRM 20	Turret	10
LRM 20	Turret	10
Ammo (LRM) 18	Body	3
Medium Laser	Turret	1
Medium Laser	Turret	1
LRM 10	Front	5
Ammo (LRM) 12	Body	1
Cargo	Body	.25

Type: **Rhino**
 Technology Base: Inner Sphere
 Movement Type: Tracked
 Tonnage: 80

Equipment	Mass
Internal Structure:	8
Engine:	240
Type:	Fusion
Cruising MP:	3
Flank MP:	5
Heat Sinks:	10
Control Equipment:	4
Lift Equipment:	0
Power Amplifier:	0
Turret:	2.5
Armor Factor:	272
	Armor Value
Front	64
R/L Side	54/54
Rear	40
Turret	60

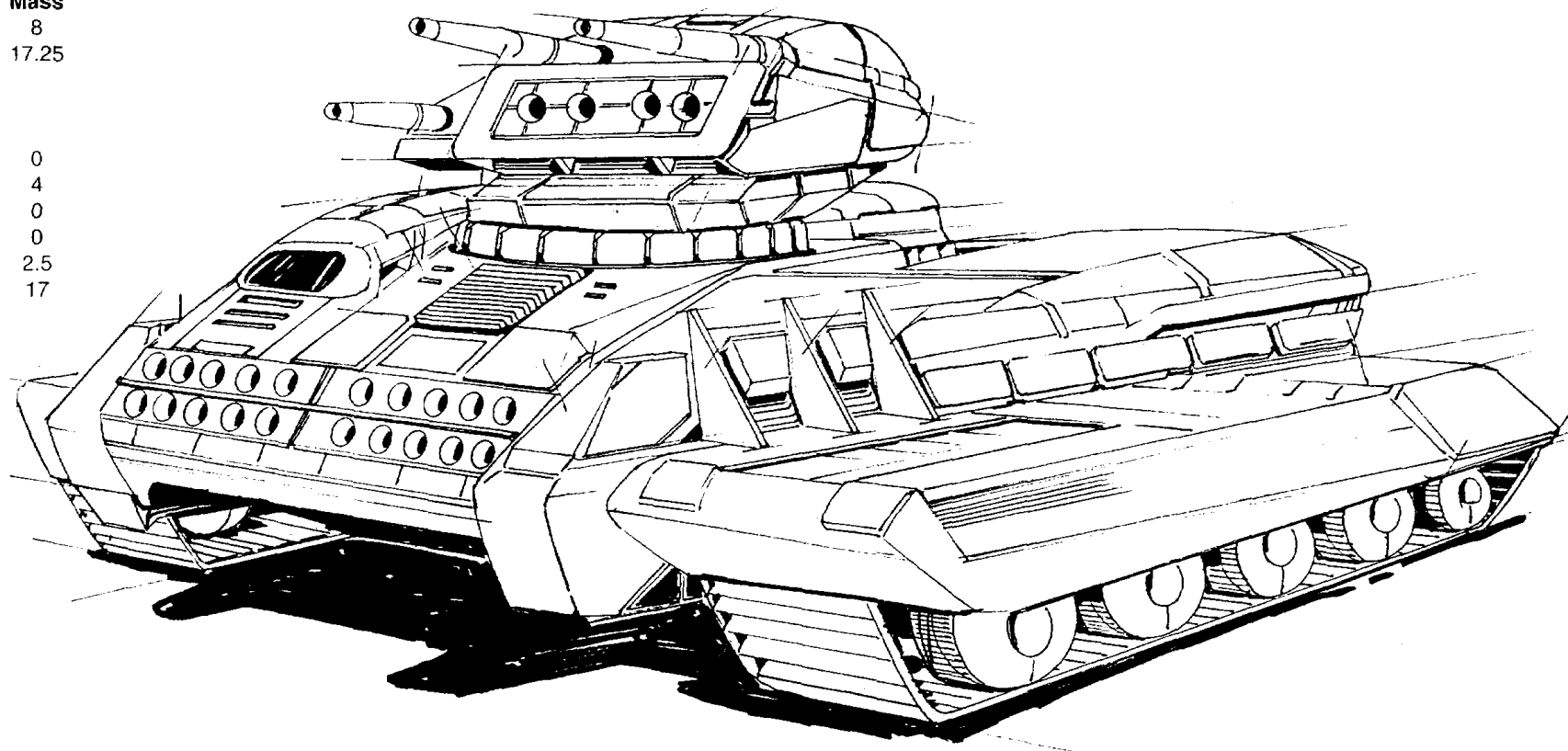

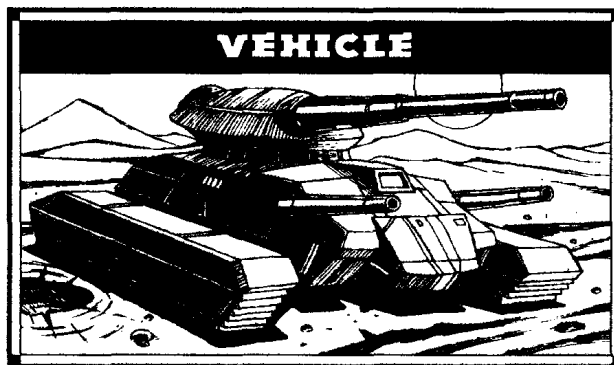

OVERVIEW

Slow and bulky, the 95-ton Puma tank first appeared in 2650 with a myriad of problems. One of the most serious was outdated environmental controls that caused many deaths among the crew from gas leaks or pulse radiation. By the time the PMA-005 design was introduced, most crewmen were wary of the vehicle despite major modifications.

The Puma's main strength is the variety of its firepower, which allows it to perform well in different combat situations. The Donal particle projection cannon mounted in the turret can deal considerable destruction to enemy forces. The twin-mounted Holly missile racks on the sides of the tank have armored doors that open forward so the racks can pivot 60 degrees, allowing the missiles to fire forward or angle sideways. The weakest spot in the tank's armor is the rear, which is protected by a Skylight Model 5 flamer and a Kreiger small laser. Though little use against BattleMechs, these light armaments effectively discourage enemy infantry from rear attacks. The turret gunnery officer controls both of these systems, however, creating difficulty if battlefield conditions make it necessary to fire forward and backward at the same time.

A number of emergency escape hatches for the crew were built into the revised Puma, including one in the tank's floor, designed to be blown open by a small charge if necessary. The Puma carries a sizeable amount of AmberStar Weave armor, but many military experts point out that the angle of the armor is too steep and the edges of the tank too sharp to deflect shots.

The Puma II variant has better armor sloping and more power than its standard counterpart. In addition, the PPC and Holly rack are replaced by several large lasers and LRM-15 racks.

Mass: 95 tons
Movement Type: Tracked
Power Plant: Pitban 285
Cruising Speed: 32 kph
Flank Speed: 54 kph
Armor: AmberStar Weave
Armament:

- 2 Holly LRM-20 Missile Racks
- 1 Donal Technologies PPC
- 2 Krieger Medium Lasers
- 1 Holly SRM-4 Missile Rack
- 1 SkyLight Model 5 Flamer
- 1 Krieger Small Laser

Weapons and Ammo	Location	Tonnage
LRM 20	Right	10
LRM 20	Left	10
Ammo (LRM) 12	Body	2
PPC	Turret	7
Medium Laser	Front	1
Medium Laser	Front	1
SRM 4	Front	2
Ammo (SRM) 25	Body	1
Flamer (Vehicle)	Rear	.5
Ammo (Flamer) 20	Body	1
Small Laser	Rear	.5

Manufacturer: Pandora 'Mech Works Inc.
Communications System: COMTEC 400E
Targeting and Tracking System: GroundTracker EE-4

Type: Puma
 Technology Base: Inner Sphere
 Movement Type: Tracked
 Tonnage: 95

Equipment	Mass
Internal Structure:	9.5
Engine:	24.75
Type:	Fusion
Cruising MP:	3
Flank MP:	5
Heat Sinks:	7
Control Equipment:	4.75
Lift Equipment:	0
Power Amplifier:	0
Turret:	1
Armor Factor:	12
	<i>Armor Value</i>
Front	50
R/L Side	34/34
Rear	24
Turret	50

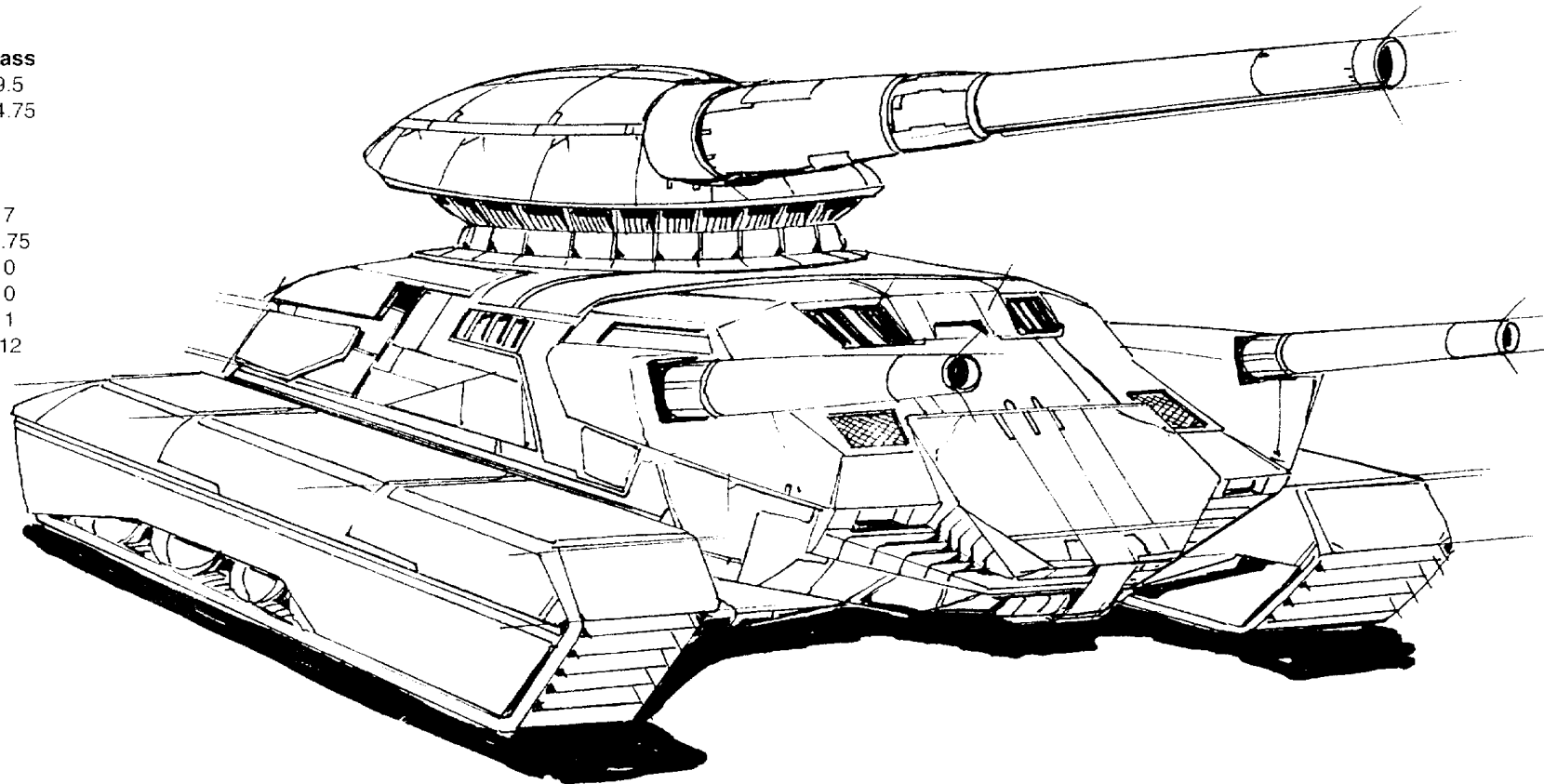

BattleMech/Vehicle

Annihilator	180	Flashman	150	Nightshade	196
Assassin	82	Flea	46	Orion	152
Atlas	182	Fury	218	Panther	76
Awesome	154	Gabriel	188	Puma Omnimech	16
Axman	130	Gladiator	38	Puma Tank	222
Banshee	178	Grand Dragon	124	Quickdraw	128
Beagle	192	Grasshopper	144	Raven	78
Black Hawk	22	Guillotine	146	Rhino	220
Black Knight	148	Hatamoto-chi	158	Ripper	190
Blackjack	96	Katana	166	Rotunda	194
Bombardier	132	Hatchetman	98	Ryoken	24
Burke	216	Hermes	62	Sentinel	90
Caesar	140	Hermes II	88	Shogun	168
Cataphract	142	Highlander	174	Spider	68
Catapult	134	Hoplite	118	Stalker	170
Centurion	106	Hornet	48	Thor Omnimech	30
Champion	122	Hunchback	112	Thor Tank	208
Chaparral	204	Hussar	64	Thorn	52
Charger	156	Imp	184	Thug	160
Cicada	84	JagerMech	138	Trebuchet	114
Clint	86	Javelin	66	Uller	14
Commando	54	Jenner	74	UrbanMech	70
Crab	108	Kanga	206	Victor	162
Cyclops	172	King Crab	186	Vindicator	100
Cyrano	198	Kintaro	120	Vulcan	92
Daishi	40	Koshi	12	Vulture	26
Dasher	10	Lancelot	126	Whitworth	94
Demon	210	Lightning	200	Wolf Trap	102
Dervish	116	Loki	28	Wolfhound	80
Dragonfly	18	Mad Cat	32	Wyvern	104
Enforcer	110	Magi	214	Zephyr	202
Exterminator	136	Man O' War	34	Zeus	164
Falcon	58	Marksman	212		
Fenris	20	Masakari	36		
Firefly	60	Mauler	176		
Firestarter	72	Mercury	50		
		Mongoose	56		



TECHNICAL READOUT

3050

MORE THAN 250 YEARS AGO, ALEKSANDR KERENSKY, PROTECTOR-GENERAL OF THE STAR LEAGUE, LEFT KNOWN SPACE. WITH HIM HE TOOK NEARLY HALF THE MECHWARRIORS, BATTLEMECHS AND SUPPORT PERSONNEL IN THE INNER SPHERE. IN THE YEARS THAT FOLLOWED, THE INNER SPHERE'S SUCCESSOR STATES BATTLED FOR SUPREMACY, WAGING TERRIBLE WARS THAT CLAIMED MILLIONS OF LIVES AND CRIPPLED THEIR TECHNOLOGICAL KNOWLEDGE AND MANUFACTURING CAPABILITIES. NOW THE DESCENDANTS OF KERENSKY ARE RETURNING, ARMED WITH SUPERIOR 'MECHS AND DRIVEN BY ONE GOAL—TOTAL DOMINATION OF THE INNER SPHERE.

BATTLETECH TECHNICAL READOUT: 3050 PROVIDES ILLUSTRATIONS, DESCRIPTIONS AND GAME STATISTICS FOR ALL STATE-OF-THE-ART INNER SPHERE BATTLEMECHS AND THE OMNIMECHS USED BY THE INVADING CLANS. TECHNICAL READOUT: 3050 ALSO INCLUDES ENTRIES ON RARE STAR LEAGUE-ERA COMBAT VEHICLES THAT HAVE RECENTLY BEGUN RESURFACING IN ACTIVE DUTY.

FOR USE WITH BATTLETECH

FASA
CORPORATION

BATTLETECH is a Registered
Trademark of FASA Corporation.
BATTLETECH TECHNICAL READOUT: 3050™
is a Trademark of FASA Corporation.
Copyright © 1996 FASA Corporation.
All Rights Reserved.



9 781555 603113

51800

ISBN# 1-55560-311-4 \$18.00